

# **DAS4672 IP-DSLAM**

## **System Configuration Guide**

Class:	User Guide
Product Name:	DAS4672
Product Version:	S.W. 2.0.0, H.W. NC-V5, ALC-V3
Doc. No.:	BCD3-TM-E-230502
Doc. Version:	1.6
Publish Date:	2007-July-10

THE SPECIFICATIONS AND INFORMATION REGARDING THE PRODUCTS IN THIS MANUAL ARE SUBJECT TO CHANGE WITHOUT NOTICE. ALL STATEMENTS, INFORMATION, AND RECOMMENDATIONS IN THIS MANUAL ARE BELIEVED TO BE ACCURATE BUT ARE PRESENTED WITHOUT WARRANTY OF ANY KIND, EXPRESS OR IMPLIED. USERS MUST TAKE FULL RESPONSIBILITY FOR THEIR APPLICATION OF ANY PRODUCTS.

THE SOFTWARE LICENSE AND LIMITED WARRANTY FOR THE ACCOMPANYING PRODUCT ARE SET FORTH IN THE INFORMATION PACKET THAT SHIPPED WITH THE PRODUCT AND ARE INCORPORATED HEREIN BY THIS REFERENCE.

NOTWITHSTANDING ANY OTHER WARRANTY HEREIN, ALL DOCUMENT FILES AND SOFTWARE OF THESE SUPPLIERS ARE PROVIDED "AS IS" WITH ALL FAULTS. PRODUCT AND THE ABOVE-NAMED SUPPLIERS DISCLAIM ALL WARRANTIES, EXPRESSED OR IMPLIED, INCLUDING, WITHOUT LIMITATION, THOSE OF MERCHANTABILITY, FITNESS FOR A PARTICULAR PURPOSE AND NONINFRINGEMENT OR ARISING FROM A COURSE OF DEALING, USAGE, OR TRADE PRACTICE.

IN NO EVENT SHALL PRODUCT OR ITS SUPPLIERS BE LIABLE FOR ANY INDIRECT, SPECIAL, CONSEQUENTIAL, OR INCIDENTAL DAMAGES, INCLUDING, WITHOUT LIMITATION, LOST PROFITS OR LOSS OR DAMAGE TO DATA ARISING OUT OF THE USE OR INABILITY TO USE THIS MANUAL, EVEN IF PRODUCT OR ITS SUPPLIERS HAVE BEEN ADVISED OF THE POSSIBILITY OF SUCH DAMAGES.

*DAS4672 IP-DSLAM*  
*System Configuration Guide*  
Text Part Number: 2305-0216

## Table of Contents

<b><u>Chapter 1 Preface.....</u></b>	<b><u>1</u></b>
Purpose.....	1
Organization.....	1
Conventions.....	1
<b><u>Chapter 2 DAS4672 User Interface.....</u></b>	<b><u>3</u></b>
User Interface Mode.....	3
Access via the Console Port.....	3
Access using the Telnet Session.....	3
Managing the Session Login Account.....	4
Command Syntax and Operating Regulation.....	6
Syntax Notation Conventions.....	6
Structure of a CLI Command.....	6
Port Interface Indication .....	7
Command Syntax and Context Sensitive Help.....	8
Command History and Editing Features.....	8
Ending a Session.....	9
<b><u>Chapter 3 Initialing the DAS4672.....</u></b>	<b><u>11</u></b>
Verifying Current Software and Hardware Versions.....	11
Managing the Boot Section.....	12
Configuring the System Information.....	12
Planning the System Card Type.....	13
Configuring the UGE Negotiation Mode.....	14
Configuring the System Date and Time .....	14
Configuring the Internet Time Server.....	15
Configuring the SNMP Manager.....	16
Configuring the DNS Server.....	18
Configuring the Management Interface.....	19
Setting the Management Ethernet (NME) Interface IP Address.....	19
Setting the in-band Interface (UGE) IP Address.....	20
Configuring the Default Gateway.....	21
Configuring the Secured Host.....	21
Configuring the Redundancy.....	22
Storing the Active System Configuration.....	23
SHDSL Firmware Upgrade.....	24
Ambient Temperature.....	25
Checking the SFP module information.....	25
<b><u>Chapter 4 Managing the System Profiles.....</u></b>	<b><u>27</u></b>
Overview of System Profile.....	27
Managing the ADSL Performance Alarm Profile.....	27
Managing the SHDSL Performance Alarm Profile.....	30
Managing the ADSL Port Connection Profile.....	32
Managing the SHDSL Port Connection Profile.....	36
Managing the IP Traffic Profile.....	37
Managing the Traffic Policing Profile.....	38
Managing the Multicast Service Profile.....	39
Multicast Channel Profile Setting.....	39
Multicast Service Profile Setting.....	40
<b><u>Chapter 5 Managing the Subscriber Interface.....</u></b>	<b><u>43</u></b>
Configuring the ADSL Line Port.....	43
Monitoring the ADSL Connection Status.....	44
Configuring the SHDSL Line Port.....	46
Monitoring the SHDSL Connection Status.....	47
Subscriber Interface Administrating.....	47

<b><u>Chapter 6 Managing the Network Interface.....</u></b>	<b><u>49</u></b>
Configuring the Subtending.....	49
Configuring the RSTP.....	50
Configuring the LACP.....	52
Network Interface Administrating.....	54
<b><u>Chapter 7 Managing the Connection Services.....</u></b>	<b><u>55</u></b>
Configuring the Bridged Services.....	55
Configuring the Routed Services.....	56
Configuring the Multicast Services.....	57
Monitoring the VC-to-VLAN Connection Status.....	58
Unicast Connection Status.....	58
Multicast Connection Status.....	59
Configuring the System Services.....	59
Bridged Services Setting.....	59
DHCP Broadcast Control.....	60
DHCP Relay Setting.....	61
DHCP Relay Option 82 Setting.....	61
IGMP Snooping/Proxy Setting.....	62
Configuring the PPPoE Suboption.....	63
Managing the Subscriber Access Services.....	64
Configuring the Access Control List.....	64
Configuring the VLAN MAC Limitation.....	65
Monitoring the VLAN Group.....	66
Monitoring the IGMP Snoopy/Proxy Information.....	66
Monitoring the Subscriber MAC.....	67
Filtering the NetBIOS and NetBEUI.....	67
Configuring the MAC Spoofed.....	68
<b><u>Chapter 8 Managing the System Operations.....</u></b>	<b><u>69</u></b>
Card Module Operations.....	69
Defining the Line Card Operation Mode.....	69
System Administrating.....	70
Reset the Line Card and Port.....	70
Reboot the System.....	71
Session Logout.....	71
Alarm Definition and Relay Setting.....	71
Configuring the Alarm Definition.....	72
Configuring the System Relay-In Alarm.....	73
Configuring the CoS Traffic Mapping.....	73
Configuring the Differentiated Service.....	74
<b><u>Chapter 9 Diagnostic and Performance Monitoring.....</u></b>	<b><u>77</u></b>
Performance Monitoring on System and Network Interface.....	77
Performance Monitoring on ADSL Subscriber Interface.....	78
Performance Monitoring on SHDSL Subscriber Interface.....	79
Monitoring System Alarms.....	79
OAM and Loop Diagnostic Test on Subscriber Interface.....	81
OAM F5 VC Diagnostic.....	81
ADSL Loop Diagnostic.....	82
ADSL Link Monitoring.....	83
SELT Link Monitoring.....	83
Network Ping Test.....	84
Monitoring the System Environment.....	84

## List of Figures

<b>Figure 2-1 DAS4672 Port Addressing Diagram.....</b>	<b>7</b>
<b>Figure 6-2 Daisy-Chain Topology for DAS-4672-10 NC Card.....</b>	<b>49</b>
<b>Figure 6-3 Spanning Tree Active Topology.....</b>	<b>50</b>
<b>Figure 6-4 Typical GE-Channel Configuration.....</b>	<b>53</b>
<b>Figure 8-5 DiffServ Field.....</b>	<b>74</b>



## List of Tables

<b>Table 2-1 DAS4672 Console Management Setting.....</b>	<b>3</b>
<b>Table 2-2 DAS4672 Default Login Account Index.....</b>	<b>4</b>
<b>Table 2-3 User Account Management.....</b>	<b>5</b>
<b>Table 2-4 Syntax Notation of CLI Ex.....</b>	<b>6</b>
<b>Table 2-5 Structure of CLI Ex Mode.....</b>	<b>7</b>
<b>Table 2-6 Port Interface Indication Format.....</b>	<b>8</b>
<b>Table 2-7 CLI Ex Syntax Help.....</b>	<b>8</b>
<b>Table 2-8 Command History and Editing.....</b>	<b>9</b>
<b>Table 3-9 Software and Firmware Verify.....</b>	<b>11</b>
<b>Table 3-10 System Information Configuration.....</b>	<b>12</b>
<b>Table 3-11 System Information Configuration.....</b>	<b>13</b>
<b>Table 3-12 Planning the system card type.....</b>	<b>14</b>
<b>Table 3-13 Configuring the UGE Negotiation Mode.....</b>	<b>14</b>
<b>Table 3-14 System Date Time Configuration.....</b>	<b>15</b>
<b>Table 3-15 Internet Time Server Setting.....</b>	<b>16</b>
<b>Table 3-16 SNMP Community Setting.....</b>	<b>17</b>
<b>Table 3-17 SNMP Trap Station Setting.....</b>	<b>17</b>
<b>Table 3-18 DNS Server Setting.....</b>	<b>18</b>
<b>Table 3-19 Management Interface IP Address Setting.....</b>	<b>19</b>
<b>Table 3-20 Secured Host Configuration.....</b>	<b>22</b>
<b>Table 3-21 Redundancy Setting.....</b>	<b>23</b>
<b>Table 3-22 Store the Active System Configuration.....</b>	<b>23</b>
<b>Table 3-23 SHDSL Firmware Upgrade.....</b>	<b>24</b>
<b>Table 3-24 Configuring Ambient Temperature.....</b>	<b>25</b>
<b>Table 3-25 Checking the SFP module information.....</b>	<b>26</b>
<b>Table 4-26 ADSL Performance Alarm Profile Configuration.....</b>	<b>28</b>
<b>Table 4-27 SHDSL Performance Alarm Profile Configuration.....</b>	<b>31</b>
<b>Table 4-28 ADSL Port Connection Profile Configuration.....</b>	<b>32</b>
<b>Table 4-29 SDSL Port Connection Profile Configuration.....</b>	<b>36</b>
<b>Table 4-30 IP Traffic Profile Configuration.....</b>	<b>38</b>
<b>Table 4-31 Traffic Policing Profile Configuration.....</b>	<b>38</b>

<b>Table 4-32 Multicast Channel Profile Configuration.....</b>	<b>39</b>
<b>Table 4-33 Multicast Service Profile Configuration.....</b>	<b>40</b>
<b>Table 5-34 ADSL Port Interface Configuration.....</b>	<b>43</b>
<b>Table 5-35 ADSL Connection Status Monitor.....</b>	<b>45</b>
<b>Table 5-36 SHDSL Port Interface Configuration.....</b>	<b>46</b>
<b>Table 5-37 ADSL Connection Status Monitor.....</b>	<b>47</b>
<b>Table 5-38 ADSL Services Administration.....</b>	<b>47</b>
<b>Table 6-39 Subtending Configuration.....</b>	<b>49</b>
<b>Table 6-40 RSTP Switch Configuration.....</b>	<b>51</b>
<b>Table 6-41 RSTP Port Configuration.....</b>	<b>52</b>
<b>Table 6-42 LACP Configuration.....</b>	<b>53</b>
<b>Table 6-43 ADSL Services Administration.....</b>	<b>54</b>
<b>Table 7-44 Bridged Services Configuration.....</b>	<b>55</b>
<b>Table 7-45 Routed Services Configuration.....</b>	<b>56</b>
<b>Table 7-46 Multicast Services Configuration.....</b>	<b>57</b>
<b>Table 7-47 Unicast Connection Status Monitor.....</b>	<b>58</b>
<b>Table 7-48 Multicast Connection Status Monitor.....</b>	<b>59</b>
<b>Table 7-49 Bridged Services Setting.....</b>	<b>60</b>
<b>Table 7-50 DHCP Broadcast Control.....</b>	<b>60</b>
<b>Table 7-51 DHCP Relay Setting.....</b>	<b>61</b>
<b>Table 7-52 DHCP Relay Option 82 Setting.....</b>	<b>62</b>
<b>Table 7-53 IGMP Snooping/Proxy Setting .....</b>	<b>62</b>
<b>Table 7-54 PPPoE Suboption Setting.....</b>	<b>63</b>
<b>Table 7-55 Access Services Configuration.....</b>	<b>64</b>
<b>Table 7-56 Access Control List Configuration.....</b>	<b>65</b>
<b>Table 7-57 VLAN MAC Limiting Configuration.....</b>	<b>66</b>
<b>Table 7-58 Viewing Subscriber VLAN Group.....</b>	<b>66</b>
<b>Table 7-59 Viewing IGMP Proxy Information.....</b>	<b>67</b>
<b>Table 7-60 VC MAC Learning Table.....</b>	<b>67</b>
<b>Table 7-61 NetBIOS and NetBEUI Filter.....</b>	<b>68</b>
<b>Table 7-62 MAC Spoofed Configuring.....</b>	<b>68</b>
<b>Table 8-63 Plan the Line Card Slot.....</b>	<b>69</b>
<b>Table 8-64 Line Card and Port Reset Command.....</b>	<b>70</b>



<b>Table 8-65 System Reboot Command.....</b>	<b>71</b>
<b>Table 8-66 Session Logout Command.....</b>	<b>71</b>
<b>Table 8-67 Alarm Definition Configuration.....</b>	<b>72</b>
<b>Table 8-68 System Relay-In Alarm Configuration.....</b>	<b>73</b>
<b>Table 8-69 CoS Traffic Mapping.....</b>	<b>74</b>
<b>Table 8-70 Configuring the DiffServ.....</b>	<b>74</b>
<b>Table 8-71 Precedence Level.....</b>	<b>75</b>
<b>Table 8-72 DSCP Class Relationship.....</b>	<b>75</b>
<b>Table 9-73 Performance Monitoring on System and Network Interface 77</b>	
<b>Table 9-74 Performance Monitoring on ADSL Subscriber Interface....</b>	<b>78</b>
<b>Table 9-75 Performance Monitoring on SHDSL Subscriber Interface .</b>	<b>79</b>
<b>Table 9-76 Viewing the System Alarm.....</b>	<b>79</b>
<b>Table 9-77 OAM F5 VC Diagnosis Test.....</b>	<b>81</b>
<b>Table 9-78 ADSL Loop Diagnostic Test.....</b>	<b>82</b>
<b>Table 9-79 ADSL Link Monitoring.....</b>	<b>83</b>
<b>Table 9-80 SELT Link Monitoring.....</b>	<b>84</b>
<b>Table 9-81 Network Ping Test.....</b>	<b>84</b>
<b>Table 9-82 System Environment Monitoring.....</b>	<b>85</b>

**This page is leave in blank for note or memo use**

## Chapter 1 Preface

---

This preface discusses the following topics:

- Purpose
- Organization
- Conventions

### Purpose

The purpose of this guide is to provide detailed information and description of DAS4672 IP-DSLAM, which includes software configuration and other specific features.

### Organization

This guide contains the following information:

- Preface
- DAS4672 User Interface
- Initialing the DAS4672
- Managing the System Profiles
- Managing the Subscriber Interface
- Managing the Network Interface
- Managing the Unicast Services
- Managing the Multicast Services
- Configuring the System Functions
- Diagnosis and Performance Monitoring
- Appendix

### Conventions

This section describes the conventions used in this guide.

The DAS4672 IP-DSLAM is the Next-Generation xDSL Broadband Access Network comprises a Gigabit Ethernet and a number of ATU-Rs, STU-Rs, and POTS splitter to construct a broadband access network between central office and customer premises. The DAS4672 IP-DSLAM uses statistically multiplexing and ATM over xDSL technologies to provide the broadband data communication services, such as high speed Internet access and multimedia services, across existing twisted pair telephone line.

**NE/NEs** hereinafter referred as DAS4672 medium capacity IP-DSLAM, unless specifically indicated.

**ADSL** mention in this document covers ADSL, ADSL2, and ADSL2+, unless specifically indicated.

**xDSL** hereinafter referred as ADSL, unless specifically indicated.





The **xDSL** specified in this document compliance with ITU-T Rec. G.992.1, G.992.2, G.992.3 and G.992.5 for ADSL.

**CLI Ex** – The command line management with a local console or Telnet through in-band or out-of-band IP interface for CIT (Craft Interface Terminal) connection.

**AMS** – AM Management System (AMS), a complete centralized SNMP base NMS (Network Management System) provides GUI operation under Client-Server architecture through in-band or out-of-band IP interface to carrying out day of day operation, administration, maintenance, and configuration functions of the NE.

- **AMS Client** – Software system for Network Management System (NMS), it's in Client-Server architecture and has ability to provide controlling and management for the whole network through GUI interface to collocate with AMS Server.
- **AMS Server** – The server station provides multiple NEs management and Database in order to perform reliability, stability, and flexibility to entire network management.

**AMS LCT** – AMS Local Craft Terminal (LCT), a stand-alone host with SNMP base EMS (Element Management System) provides GUI operation under single section through in-band or out-of-band IP management interface.

	This sign indicates the <b>NOTICE</b> . A note contains helpful suggestions or reference relay on the topical subjects.
	This sign indicates the <b>TIP</b> . Performing the information described in the paragraph will help you solve a problem. The tip information might not be troubleshooting or even an action, but could be useful information.
	This sign indicates the <b>CAUTION</b> . In this situation, you might do something that could result in equipment damage or loss of data.
	This sign indicates the <b>DANGER</b> . You are in situation that could cause bodily injury. Before you work on any equipment, you must be aware of the hazards involved with electrical circuitry and be familiar with standard practices for preventing accidents.

## Chapter 2 DAS4672 User Interface

---

This chapter describes the DAS4672 user interface, the instructions describe how to using the command-line interface, and also describes the command editing and command history features that enable you to recall previous command entries and edit previously entered commands.

- User Interface Mode
- Access via the Console Port
- Access using the Telnet Session
- Managing the Session Login Account
- Command Syntax and Operating Regulation

### User Interface Mode

The DAS4672 provides the user access mode to allow user to login, it requires a password with remote Telnet and Console access, this user configuration interface mode is called CLI Ex mode.

### Access via the Console Port

Access to CLI Ex mode via the Console Port can be done using a VT100-compatible terminal directly connected.

To access the CLI Ex mode via a direct VT100-compatible terminal connection to the Console Port, use the following procedures:

**Step 1** Set the communication parameters of a VT100-compatible terminal as follows:

**Table 2-1 DAS4672 Console Management Setting**

Parameter	Setting
Baud rate	9600
Data bits	8
Parity	None
Start bits	1
Stop bits	1
Flow control	None

**Step 2** Connect the VT100-compatible terminal to the Console Port of the DAS4672 front panel.

**Step 3** Press <Enter> a number of times until the “**Login:**” is display on the screen.

The Console session required a username and password to access, the default administration username and password is list in below (case sensitive):

Login: **admin**

Password: **admin**

See “Chapter 2 Managing the Session Login Account” for detail information.

### Access using the Telnet Session

Access the CLI Ex mode by establishing a Telnet session onto the assigned IP address of the

Network uplink interface.

If the IP address is changed during configuration and the change are saved, your Telnet session onto the system will be broken. You can then Telnet to the new IP address assigned during the configuration.

The IP address assigned on Network uplink interface must not be in use with another device on the same network segment or a conflict may occur. Refer to “Chapter 3 Configuring the Management Interface” for more information.

If the assign IP has been changed and forgotten, locally access the system via Console port with below command syntax to retrieve the IP address assign to the system, it also shown the system default IP address for WAN (In-band, UGE) and Management IP Interface (NME) as well as the default gateway.

### Example 1 Display the system management IP addresses

```

CLI# config ip show
UGE
  IP Address   : 192.168.3.90
  Subnet Mask  : 255.255.255.0
  MAC Address  : 00:01:02:02:01:cf
  UGE VLAN ID  : 4092
NME
  IP Address   : 10.5.1.242
  Subnet Mask  : 255.255.0.0
  MAC Address  : 00:01:0a:01:cf:cf
Gateway
  IP address   : 192.168.3.254

```

The Telnet session required a username and password to access, the default administration username and password is list in below (case sensitive):

```

User Name: admin
Password: admin

```

Telnet supports maximum of 12 sessions simultaneously login to a single NE, but only one of admin account user is allow at all time (Console access included), guest account for the rest of session limiting, the default “**admin**” account user is with administrator privilege level, see “Chapter 2 Managing the Session Login Account” for detail information.

## Managing the Session Login Account

For security reason, the CLI Ex mode provides two levels of account user privileges, “**admin**” and “**guest**”. Admin level has full access privileges while guest level has only the browse privileges. Table 2-2 shows detail system default login account and session information.

**Table 2-2 DAS4672 Default Login Account Index**

Group	Default Account	Login Mode	Session	Session Timeout
Admin	Username: admin Password: admin	Console, Telnet	Single session occupying on either Console access or Telnet access.	Console: limitless Telnet: 120 Seconds
Guest	Username: guest Password: guest	Console, Telnet	1 session for Console access, up to 12 sessions for Telnet access.	Console: limitless Telnet: 120 Seconds

Enter to the “**config mgt**” sub-group directory to create and delete the user account.

CLI# **config mgt**

CLI(config mgt)#

**Table 2-3 User Account Management**

Use this command to create the account user and it group privileges, while valid user name was defined, the password prompt will appear	
CLI(config mgt)# <b>add user</b> <name> [<group>]	
Use this command to delete a user login	
CLI(config mgt)# <b>del user</b> <name>	
Use this command to change the user password	
CLI(config mgt)# <b>password</b> <user>	
Use this command to change the user group privileges	
CLI(config mgt)# <b>group</b> <name> [<group>]	
Use this command to display information of all the users. Password information is not included.	
CLI(config mgt)# <b>show</b>	
Parameters	Task
<name>	This specifies the user name and password to be created. <b>Type:</b> Mandatory <b>Valid values:</b> String of up to 16 characters ('A' – 'Z', 'a' – 'z', '0' – '9', '-', '_', ':', '@')
<user>	This specifies the current user name.
<group>	This specifies group privilege of the name user. <b>Type:</b> Option <b>Default value:</b> guest <b>Valid values:</b> admin, guest

The below example shown how to generate a new account user and join to the admin group.

### Example 2 Create a new user account

```

CLI(config mgt)# add user abc
Enter password (up to 16 character):
Confirm password:

OK

CLI(config mgt)# group abc admin
OK

CLI(config mgt)# show

management VLAN   : 4092
      user   : guest (guest)
      user   : admin (admin)
      user   : abc (admin)

```

## Command Syntax and Operating Regulation

This section describes how to configure and display the syntax notation, structure, context-sensitive, command history features, and command syntax help.

### Syntax Notation Conventions

CLI Ex command syntax using different bracket form to display syntax notation, Table below lists the notation information.

**Table 2-4 Syntax Notation of CLI Ex**

Notation	Descriptions
<b>keyword</b>	Keywords in a command that you must enter exactly as shown.
<i>&lt;Parameter&gt;</i>	Parameter values must be specified.
[ <i>&lt;Parameter&gt;</i> ]	Parameter values are optional.
[ <i>Parameter 1   Parameter 2   ..   Parameter n</i> ]	Parameter values are enclosed in “[ ..   .. ]” when you optional use one of the values specified.
{ <i>Parameter 1   Parameter 2   ..   Parameter n</i> }	Parameter values are enclosed in “{ ..   .. }” when you must use one of the values specified.

### Structure of a CLI Command

The CLI Ex commands conform to the following structure in group base. Each group contains sub-group directory or action command that can be use directly with proper syntax.

```
CLI# [[<Group-A> | <Action-A>] | [<Group-B> | <Action-B>] | [<Group-C> | <Action-C>] | <Action-D>]
```

or

```

CLI# [<Group-A> | <Action-A>]
CLI(Group-A)# [<Group-B> | <Action-B>]
CLI(Group-B)# [<Group-C> | <Action-C>]
CLI(Group-C)# <Action-D>

```



The command structure can complete in a single sentence or access into specific group directories.

**Table 2-5 Structure of CLI Ex Mode**

Keyword	Descriptions
<Group-#>	This is the group directory of a CLI Ex command which contains relative keywords under. It indicates the type of group to be performed. “ <b>config</b> ” is an example of the group directory.
<Action-#>	This is the keyword of a CLI Ex command. It indicates the type of operation to be performed. “ <b>ping</b> ” is an example of this action keyword.
Command	Descriptions
<b>exit</b>	Jump to the upper group directory.
<b>exit all</b>	Jump to the root directory <b>CLI#</b>
<b>clear</b>	Clear the screen.
Press <b>Enter / Return</b>	Execute the command.

**Port Interface Indication**

The DAS4672 is designed in single shelf and five slots, 1 for NC and 4 for xDSL LC, each xDSL LC contain maximum of 48 ports.

The interface indicate parameters <slot-id>, <port-id>, <slot-range>, and <port-range> are use to identify the particular slot/port interface or its configuration slot/port range inside the CLI Ex mode.

Figure 2-1 shows the shelf, slot, and port addressing outward on DAS4672.

**Figure 2-1 DAS4672 Port Addressing Diagram**

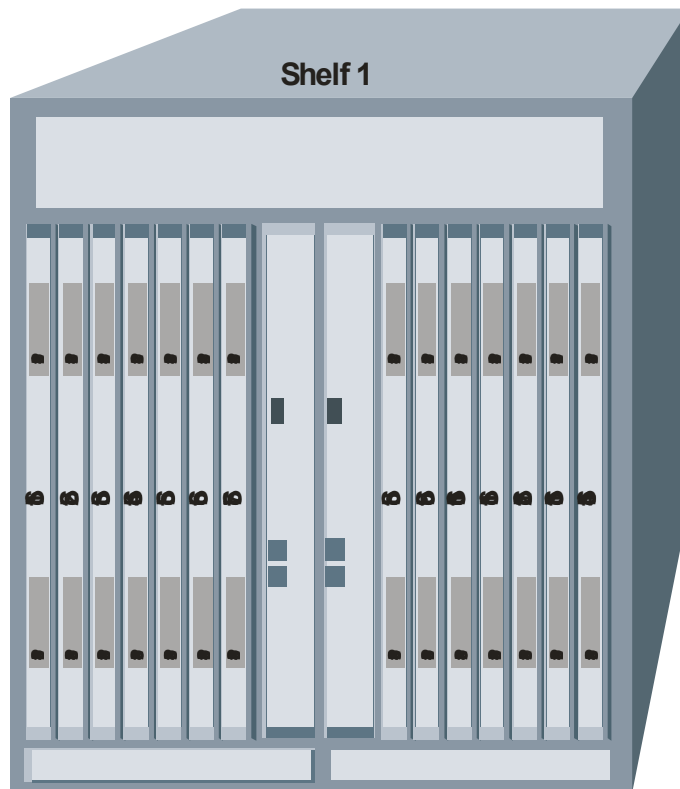

The CLI Ex mode using “.” notation to differentiate between shelf, slot, and port at interface

indicate parameters. The format of “[shelf\_#] . slot\_#” identify upon slot base for <slot-id> and <slot-range> parameters while the format of “[shelf\_#] . [slot\_#] . port\_#” identify as the port base for <port-id> and <port-range> parameters. If shelf\_# and/or slot\_# is not defined, CLI\_Ex will apply the default value automatically to those syntax.

The <slot-range> and <port-range> parameters using “-” notation to identify the continuously range, the range configuration has ability to stride over slot or shelf.

**Table 2-6 Port Interface Indication Format**

Parameters	Descriptions
<slot-id>	<b>Format:</b> [shelf_#] . slot_# <b>Valid values:</b> shelf_# (1), slot_# (1 ~ 4) <b>Default value:</b> shelf_# (1)
<port-id>	<b>Format:</b> [shelf_#] . [slot_#] . port_# <b>Valid values:</b> shelf_# (1), slot_# (1 ~ 4), port_# (1 ~ 48) <b>Default value:</b> shelf_# (1), slot_# (1)
<slot-range>	<b>Format (Continuously):</b> [shelf_#] . slot_# - [shelf_#] . slot_# <b>Format (Individually):</b> [shelf_#] . slot_# <b>Valid values:</b> shelf_# (1), slot_# (1 ~ 4) <b>Default value:</b> shelf_# (1)
<port-range>	<b>Format (Continuously):</b> [shelf_#] . [slot_#] . port_# - [shelf_#] . [slot_#] . port_# <b>Format (Individually):</b> [shelf_#] . [slot_#] . port_# <b>Valid values:</b> shelf_# (1), slot_# (1 ~ 4), port_# (1 ~ 48) <b>Default value:</b> shelf_# (1), slot_# (1)

## Command Syntax and Context Sensitive Help

Fully utilize the “ ? ” command to assist your task; this command can be use to brows command and to be assistants on the command keywords or arguments.

To get help specific to a command, a keyword, or argument, perform one of these tasks:

**Table 2-7 CLI Ex Syntax Help**

Command	Task
?	To list all command available of CLI Ex mode.
Command ?	To list the associated keywords and arguments for a command.
Abbreviated-command-entry <Tab>	Complete a partial command or group directory name.

To list the command keywords, enter a question mark “ ? “ to complete the command keywords and arguments. Include a space before the ?. This form of help is called command syntax help.

The CLI Ex mode provides an error announce that appears in which you have entered an incorrect or incomplete command, syntax, keyword, or argument.

If you have entered the correct command but invalid syntax or a wrong keyword parameters, the CLI Ex will automatic prompt the error messages and reprint the command with cursor indexed on wrong syntax.

## Command History and Editing Features

By default, the system records ten command lines in its history buffer. To recall commands from

the history buffer, perform one of these commands:

**Table 2-8 Command History and Editing**

Command	Task
Press the Up arrow key	To recall commands in the history buffer. Beginning with the most recent commands. Repeat the key sequence to recall the older commands.
Press the Down arrow key	To return to more recent commands in the history buffer. Repeat the key sequence to recall the more recent commands.
Press the left arrow key	To move the cursor back one character.
Press the right arrow key	To move the cursor forward one character.
Press <b>Backspace</b>	To erase the character to the left of the cursor.
Press <b>Q</b>	To quite the print listing on the console screen.

This CLI Ex mode includes an editing feature. You can move cursor around on the command line to insert or delete the character.



The arrow keys function only on ANSI-compatible terminals such as VT100s.

## Ending a Session

If you access using the Telnet session, you can type “**logout**” command to terminate the Telnet session instantly, while in Console access will quit the CLI Ex and stay in login state.

Console port will stay in life until you close the terminal session.

Define the timeout seconds and move this section behind “Manage the Session Login Account”.

This page is leave in blank for note or memo use

## Chapter 3 Initialing the DAS4672

---

This chapter describes how to initially configure the DAS4672 IP-DSLAMs, and includes these sections:

- Verifying Current Software and Hardware Versions
- Managing the Startup Boot Section
- Configuring the System Information
- Planning the System Card Type
- Configuring the UGE Negotiation Mode
- Configuring the System Date and Time
- Configuring the Internet Time Server
- Configuring the SNMP Manager
- Configuring the DNS Server
- Configuring the Management Interface
- Storing the Active System Configuration
- SHDSL Firmware Upgrade
- Ambient Temperature
- Checking the SFP module information

### Verifying Current Software and Hardware Versions

Use the “**card show**” command under the “**status**” group directory to display the system H/W, S/W version of each plug-in card module and slot plan type.

Enter to the “**status**” group directory to verify the software and hardware versions.

```
CLI# status
CLI(STATUS)#
```

**Table 3-9 Software and Firmware Verify**

Using this command to display the system on-board card version and plugging status.
<b>CLI(STATUS)# card show</b>

#### Example 3 Monitoring the system on-board card version

```
CLI(STATUS)# card show

NC1
  current card type   : CPU Module
  planned card type  : CPU Module
  role                : active
  hardware version   : MCI2021-V5
  software version    : 1.0S1.0@R3462
  serial number      : MCI2021-11613000028
  oper status        : up
  system up time     : 0day / 0hr / 31min / 24sec
```

```

LC1
  current card type   : adsl
  planned card type  : adsl
  hardware version    : MLA2021-V2
  software version    : 6.5.7_2.4.0
  serial number       : MLA2021-1165C000933
  oper status        : up
  system up time     : 0day / 0hr / 30min / 52sec
  RFC684 encapsulation : LLC
  VLAN tag pass through : disable

```

## Managing the Boot Section

The system has two boot sections ‘opCodeA’ and ‘opCodeB’, each of it contains the firmware necessary for the system. You can manually assign the startup section for next booting or synchronize the code from one section to another.

Use the command “**boot-device**” to managing the boot section of your system.

```
CLI# boot-device
```

**Table 3-10 System Information Configuration**

Use this command to identify the startup boot section.
<b>CLI# boot-device set {opCodeA   opCodeB}</b>
Use this command to synchronize the firmware code from one section to another.
<b>CLI# bootdevice sync {opCodeA   opCodeB} {opCodeA   opCodeB}</b>
Use this command to display the current boot device and firmware file.
<b>CLI# boot-device show</b>

## Configuring the System Information

The system information contains system name, location, and contact person info, enter the ‘**systeminfo**’ sub-group under ‘**config**’ group directory to manage your NE.

Enter to the “**config systeminfo**” sub-group directory to configure the system information.

```

CLI# config systeminfo
CLI(SYSINFO)#

```

**Table 3-11 System Information Configuration**

Use this command to modify the system location.	
<b>CLI(SYSINFO)# set location</b> <string>	
Use this command to modify the system contact information.	
<b>CLI(SYSINFO)# set contact</b> <string>	
Use this command to modify the system name.	
<b>CLI(SYSINFO)# set name</b> <string>	
Use this command to monitor the system information.	
<b>CLI(SYSINFO)# show</b>	
Parameters	Task
<string>	This contains the textual identification of the information on the given field <b>Type:</b> Mandatory <b>Valid values:</b> String of up to 255 characters ('0'~'9', 'A'~'Z', 'a'~'z', '-', '_', '!', '@').

**Example 4 Modifying the name of system information**

```
CLI(SYSINFO)# set name IP_DSLAM
OK
```

```
CLI(SYSINFO)# show
```

```
System Name:      IP_DSLAM
System Contact:   <Enter your contact information>
System Description:  DAS4672 IP-DSLAM
System Location:  <Enter your physical location>
```

**Planning the System Card Type**

Enter to the “**config nc**” sub-group directory to planning the NC (Network Control) card.

```
CLI# config nc
CLI(config nc)#
```

Enter to the “**config lc**” sub-group directory to planning the LC (Line Card) card.

```
CLI# config lc
CLI(config lc)#
```

**Table 3-12 Planning the system card type**

Use this command to modify the planning NC card type.	
<b>CLI(config nc)# set planned-type</b> <nc-id> {none   cpu}	
Use this command to modify the planning LC card type.	
<b>CLI(config lc)# set planned-type</b> <lc-range> <card-type>	
Parameters	Task
<nc-id>	Identify the slot range of the NC card <b>Type:</b> Mandatory <b>Valid values:</b> 1 ~ 2 (value = 2 is only on DAS4672)
{none   cpu}	Identify the NC type.
<lc-range>	Identify the slot range of the Line card. <b>Type:</b> Mandatory <b>Valid values:</b> See “Chapter 2 Port Interface Indication”
<card-type>	Identify the line card type <b>Valid values:</b> none, adsl, shdsl

## Configuring the UGE Negotiation Mode

Enter to the “**config nc**” sub-group directory to planning the NC (Network Control) card.

```
CLI# config nc
CLI(config nc)#
```

**Table 3-13 Configuring the UGE Negotiation Mode**

Use this command to modify the UGE negotiation mode.	
<b>CLI(config nc)# set autoneg</b> <uge-id> {off   on}	
Parameters	Task
{off   on}	Identify the auto negotiation mode of specified UGE port. <b>Type:</b> Mandatory <b>Valid values:</b> off   on
<uge-id>	Identify the slot range of the UGE port <b>Type:</b> Mandatory <b>Valid values:</b> 1 ~ 2

## Configuring the System Date and Time

You can set the date and time parameters as part of the initial system configuration.

Set the system date and time using the “**datetime**” command at the prompt for CLI#.



The date and time will be reset every times due to system reboot, synchronize will be perform if managed under EMS Server.



**Table 3-14 System Date Time Configuration**

Use this command to set the system date time.	
<b>CLI# datetime set</b> <date> <time>	
Use this command to set the GMT time zone for system.	
<b>CLI# datetime timezone</b> <zone>	
Use this command to monitor the current system time.	
<b>CLI# datetime show</b>	
Parameters	Task
<date>	Identify the year, month, and date. <b>Type:</b> Mandatory <b>Valid values:</b> yyyy-mm-dd
<time>	Identify the time in hour, minute, and second. <b>Type:</b> Mandatory <b>Valid values:</b> hh:mm:ss
{zone}	Identify the GMT time zone. <b>Type:</b> Mandatory <b>Valid values:</b> -12 ~ +13

**Example 5 Configure the system date and time**

```

CLI# datetime set 2005-03-10 10:38:00
OK

CLI# datetime timezone +8
OK

CLI# datetime show
datetime: 2005-03-10 10:38:11 GMT+8
    
```

**Configuring the Internet Time Server**

Enable the time server to allow the IP-DSLAM clock to synchronize with an Internet time server.

Enter to the “**config timeservice**” sub-group directory to configure the Internet time server.

**Table 3-15 Internet Time Server Setting**

Use this command to enable the time server IP address or domain name.	
<b>CLI(TIMESERVICE)# servers set</b> <server1   server2   server3> <address>	
Use this command to disable the time server.	
<b>CLI(TIMESERVICE)# servers delete</b> <server1   server2   server3>	
Use this command to define the synchronization protocol.	
<b>CLI(TIMESERVICE)# set protocol</b> <none   sntp>	
Use this command to define the synchronization time period.	
<b>CLI(TIMESERVICE)# set timezone</b> <zone-value>	
Use this command to define the synchronization time period.	
<b>CLI(TIMESERVICE)# set period</b> <time>	
Use this command to display the time server configuration information.	
<b>CLI(TIMESERVICE)# show</b>	
Use this command to manually synchronize with time server.	
<b>CLI(TIMESERVICE)# update</b>	
Parameters	Task
<address>	This specifies the network IP address or domain name for Internet time server. <b>Type:</b> Mandatory <b>Valid values:</b> Any valid class A/B/C IP address or domain name
<zone-value>	Identify the GMT time zone. <b>Type:</b> Mandatory <b>Valid values:</b> -12 ~ +13
<time>	This specifies the automatic synchronizing time period <b>Type:</b> Mandatory <b>Valid values:</b> 1 ~ 1440 Minutes

## Configuring the SNMP Manager

The DAS4672 supports SNMP (Simple Network Management Protocol) v1 and v2c, the SNMP status control the management data transmitted between the device and the hosts to keep management communications private. Both the device and the host must use the same SNMP Community.

### Configuring the SNMP Community

The SNMP Community setting allows you to assign the community privilege levels. Two privilege levels are support, read-only and read-write.

Enter to the “**config snmp**” sub-group directory to configure the SNMP community.

```
CLI# config snmp
CLI(SNMP)#
```

**Table 3-16 SNMP Community Setting**

Use this command to create a new SNMP community information, system allows up to 8 of community set in maximum.	
<b>CLI(SNMP)# add community &lt;name&gt; {rw   ro}</b>	
Use this command to delete the SNMP community information.	
<b>CLI(SNMP)# del community &lt;name&gt;</b>	
Use this command to monitor the status of SNMP community sets (Community Table).	
<b>CLI(SNMP)# show community</b>	
Parameters	Task
<name>	This specifies the community name <b>Type:</b> Mandatory <b>Valid values:</b> String of up to 20 characters ('0'~'9', 'A'~'Z', 'a'~'z', '-', '_', '.', '@').
{rw   ro}	This specifies the access permissions given to managers with this community name. 'ro' implies read only permissions and 'rw' implies read-write permissions. <b>Type:</b> Mandatory

**Example 6 Add a new SNMP community to system**

```
CLI(SNMP)# add community xxx ro
OK
```

```
CLI(SNMP)# show community
```

```
Community Table:
Community   Permission
-----
"public"   read-only
"xxx"      read-only
```

**Configuring the Trap Station IP Address**

Trap operations allow SNMP agents (DAS4672) to send asynchronous notifications that an event has occurred. Traps are sent on a best-effort basis and without any method to verify whether they were received.

Enter to the “**config snmp**” sub-group directory to configure the Trap station.

```
CLI# config snmp
CLI(SNMP)#
```

**Table 3-17 SNMP Trap Station Setting**

Use this command to create a new trap station, system allows up to 8 of trap station in maximum.	
<b>CLI(SNMP)# add trapstation &lt;ip-addr&gt; &lt;community-name&gt;</b>	
Use this command to delete the trap station information.	
<b>CLI(SNMP)# del trapstation &lt;ip-addr&gt;</b>	
Use this command to monitor the status of trap stations (Trap Station Table).	
<b>CLI(SNMP)# show trapstation</b>	
Parameters	Task
<ip-addr>	The IP address of the system to receive SNMP traps. <b>Type:</b> Mandatory
<community-name>	This specifies the community name string to use when sending authentication traps. <b>Type:</b> Mandatory

**Example 7 Add a new Trap station**

```
CLI(SNMP)# add trapstation 192.168.1.1 public
OK
```

```
CLI(SNMP)# enable trapstation 192.168.1.1
OK
```

```
CLI(SNMP)# show trapstation
Trap Station Table:
  IP Address      Community      Version
-----
  192.168.1.1    "public"      v2c
```

**Configuring the DNS Server**

Enter to the “**config dns**” sub-group directory to configure the DNS server.

```
CLI# config dns
CLI(config dns)#
```

**Table 3-18 DNS Server Setting**

Use this command to define the DNS server IP address.	
<b>CLI(config dns)# set {dns1   dns2   dns3} &lt;ip-addr&gt;</b>	
Use this command to delete the DNS server.	
<b>CLI(config dns)# del {dns1   dns2   dns3}</b>	
Use this command to display the DNS server.	
<b>CLI(config dns)# show</b>	
Parameters	Task
<ip-addr>	The IP address of the DNS server. <b>Type:</b> Mandatory

**Example 8 Add a new DNS server to system**

```
CLI(config dns)# set dns1 168.95.1.1
Set OK.
```

```
CLI(config dns)# set dns2 168.95.1.88
Set OK.
```

```
CLI(config dns)# show
DNS server IP
  dns1      dns2      dns3
-----
  168.95.1.1 168.95.1.88 0.0.0.0
```

## Configuring the Management Interface

This section explains how to configure an IP address on the network management Ethernet interface (nme) and uplink Network interface (uge) present on the NC (Network Control) card. The nme is an out-of-band management Ethernet port on the system engine. Packets received on this interface will never reach the switching fabric and there is no access to the nme interface except through the Management Ethernet port on the NC card.

The uge is an in-band management interface connected to the switching fabric present on the uplink gigabit Ethernet port which has ability to join the VLAN membership.

Enter to the “ip” sub-group directory to configure the management interface IP address.

```
CLI# config ip
CLI(config ip)#
```

Enter to the “config mgt” sub-group directory to configure the uge in-band interface VLAN membership.

```
CLI# config mgt
CLI(mgt)#
```

**Table 3-19 Management Interface IP Address Setting**

Use this command to assign the IP address and subnet mask for management Ethernet interface (nme).	
<b>CLI(config ip)# set nme</b> <ip-addr> <netmask> <gatewayip>	
Use this command to assign the IP address and subnet mask for uplink Network interface (uge).	
<b>CLI(config ip)# set uge</b> <ip-addr> <netmask> <gatewayip>	
Use this command to assign the default gateway. The DAS4672 sends all off-network IP traffic to the default gateway.	
<b>CLI(config ip)# set gateway</b> <ip-addr>	
Use this command to monitor the management interface information.	
<b>CLI(config ip)# show</b>	
Use this command to identify the VLAN ID for in-band management traffics.	
<b>CLI(config mgt)# set vlan</b> <vlan-id>	
Parameters	Task
<ip-addr>	This specifies the network IP address for nme and uge interface, this IP address use only for system management. <b>Type:</b> Mandatory <b>Valid values:</b> Any valid class A/B/C address <b>Default value:</b> None
<gatewayip>	This specifies the gateway IP address for system, this gateway IP address use only for system management. <b>Type:</b> Mandatory <b>Valid values:</b> Any valid class A/B/C address
<netmask>	This specifies the subnet mask configured for the interface. <b>Type:</b> Mandatory <b>Valid values:</b> 255.0.0.0 ~ 255.255.255.255
<vlan-id>	Assign the in-band interface to the proper VLAN (make sure the VLAN is associated with the network to which the IP address belongs). <b>Type:</b> Mandatory <b>Valid values:</b> 1 ~ 4094

### Setting the Management Ethernet (NME) Interface IP Address

Before you can Telnet to the DAS4672 or use SNMP to manage the DAS4672, you must assign an

IP address to either the in-band (uge) interface or the management Ethernet (nme) interface.

You can specify the subnet mask (netmask) in dotted decimal format.

To set the management Ethernet (nme) interface IP address, perform this procedure in CLI Ex mode:

**Step 1** Assign an IP address and subnet mask to the management Ethernet (nme) interface.

**Step 2** Verify the default gateway, if necessary.

The example below shows how to assign an IP address and subnet mask to the management Ethernet (nme) interface and how to verify the interface configuration.

### Example 9 Setup the out-of-band management interface

```
CLI(config ip)# set nme 172.16.1.1 255.255.0.0 172.16.1.254
OK
```

```
CLI(config ip)# show
UGE
  IP address   : 100.168.3.97
  subnet mask  : 255.255.0.0
  MAC address  : 00:11:f5:dc:7a:17
  UGE VLAN ID : 4092
```

```
NME
  IP address   : 172.16.1.1
  subnet mask  : 255.255.0.0
  MAC address  : 00:11:f5:dc:7a:16
```

```
Gateway
  IP address   : 172.16.1.254
```

### Setting the in-band Interface (UGE) IP Address

Before you can Telnet to the DAS4672 or use SNMP to manage the DAS4672, you must assign an IP address to either the in-band (uge) interface or the management Ethernet (nme) interface.

You can specify the subnet mask (netmask) in dotted decimal format.

To set the IP address and VLAN membership of the in-band (uge) management interface, perform the following procedures in CLI Ex mode:

**Step 1** Assign an IP address and subnet mask to the in-band (uge) management interface.

**Step 2** Verify the default gateway, if necessary.

**Step 3** Assign the in-band interface to the proper VLAN.

This example shows how to assign an IP address, specify the subnet mask, and specify the VLAN assignment for the in-band (uge) interface.

### Example 10 Setup the in-band management interface

```
CLI(config ip)# set uge 192.168.100.1 255.255.255.0 192.168.100.254
OK
```

```
CLI(config ip)# show
```

## UGE

IP address : 192.168.100.1  
subnet mask : 255.255.255.0  
MAC address : 00:11:f5:dc:7a:17  
UGE VLAN ID : 4092

## NME

IP address : 10.12.3.97  
subnet mask : 255.255.248.0  
MAC address : 00:11:f5:dc:7a:16

## Gateway

IP address : 192.168.100.254

CLI(config ip)# **exit**

CLI# **config mgt**

CLI(mgt)# **set vlan 10**

OK

CLI(mgt)# **show**

management VLAN : 10  
user : guest (guest)  
user : admin (admin)  
user : abc (admin)

## Configuring the Default Gateway

The DAS4672 sends IP packets destined for other IP subnets to the default gateway (typically a router interface in the same network or subnet as the switch IP address). The DAS4672 does not use the IP routing table to forward traffic from connected devices, only IP traffic generated by the DAS4672 itself (for example, Telnet, TFTP, and ping).

The switch sends all off-network IP traffic to the primary default gateway. Both the in-band (uge) and management Ethernet (nme) interfaces are specified with common default gateway, the system forward traffics automatically determines through which interface the default gateway can be reached.

## Configuring the Secured Host

The security host mechanism protects the IP-DSLAM against unauthorized access from untrusted host. This feature allows you to specify the trusted host IPs and authorized services (e.g. SNMP, TELNET, and FTP)

Enter to the “**config secure**” sub-group directory to configure the secured host IP address.

CLI# **config secure**

CLI(SECURE)#

**Table 3-20 Secured Host Configuration**

Use this command to specify the secured host with all permission services.	
<b>CLI(SECURE)# allow &lt;index&gt; all</b>	
Use this command to specify the secured host with none permission services.	
<b>CLI(SECURE)# allow &lt;index&gt; none</b>	
Use this command to specify the secured host in a specifics service.	
<b>CLI(SECURE)# allow &lt;index&gt; &lt;snmp,telnet,ftp,tftp&gt;</b>	
Use this command to enable the secured host feature.	
<b>CLI(SECURE)# enable</b>	
Use this command to disable the secured host feature.	
<b>CLI(SECURE)# disable</b>	
Use this command to specify the secured host IP range.	
<b>CLI(SECURE)# set &lt;index&gt; &lt;from-ip&gt; [&lt;to-ip&gt;]</b>	
Use this command to displays the information of secured host.	
<b>CLI(SECURE)# show [&lt;index&gt;]</b>	
Parameters	Task
<index>	This specifies the entry number of secured host list. <b>Valid values:</b> 1 ~ 10
<snmp,telnet,ftp,tftp>	This specifies the permission service of secure host, using “,” to successive service in multiple selection. <b>Valid values:</b> snmp, telnet, ftp, tftp
<from-ip>	This specifies the start IP address <b>Valid values:</b> 0.0.0.0 ~ 255.255.255.255
<to-ip>	This specifies the end IP address <b>Valid values:</b> 0.0.0.0 ~ 255.255.255.255

## Configuring the Redundancy

When two NC card is equipped in the system, the redundancy mechanism will automatically operation, you can configure the parameters of synchronization the configuration data information between NC1 and NC2 through below.

Enter to the “**config redundancy**” sub-group directory to operation.



**Table 3-21 Redundancy Setting**

Use this command to enable or disable the auto configuration data synchronize between NC1 and NC2.	
<b>CLI(REDUNDANCY)# set sync &lt;option&gt;</b>	
Use this command to define the synchronization period.	
<b>CLI(REDUNDANCY)# set sync &lt;period&gt;</b>	
Use this command to display the redundancy setting information.	
<b>CLI(REDUNDANCY)# show</b>	
Use this command to manually synchronize the configuration data between NC1 and NC2.	
<b>CLI(REDUNDANCY)# sync</b>	
Parameters	Task
<option>	Enable or disable redundancy auto synchronizations. <b>Valid values:</b> enable, disable
<period>	The information of System configuration synchronization period between NC1 and NC2. <b>Valid values:</b> 30 ~ 3600 seconds. <b>Default values:</b> 300

## Storing the Active System Configuration

Configuration modified under “**config**” directory without saving (storing) will be lost due to hardware reboot.

Use “**save**” command under “**config file**” sub-group directory to save your active configuration in system flash, DAS4672 will load the new setting whenever the system reboot.

Enter to the “**config file**” sub-group directory to operation.

```
CLI# config file
CLI(config file)#
```

**Table 3-22 Store the Active System Configuration**

Use this command to save current configuration and backup old configuration.
<b>CLI(config file)# save</b>
Use this command to remove all save configuration files.
<b>CLI(config file)# erase</b>
Use this command to show configuration information.
<b>CLI(config file)# ls</b>

System configures saving takes around 15 seconds to finish in normal.

### Example 11 Save the system configuration

```
CLI(config file)# save

OK
CLI(config file)# ls
Listing directory [cfg:]
-rwxrwxrwx 1 0 0 133630 Oct 10 12:45 default.cfg
-rwxrwxrwx 1 0 0 32 Oct 10 12:45 default.md5
-rwxrwxrwx 1 0 0 37 Oct 10 00:11 mac.cfg
```

## SHDSL Firmware Upgrade

This section explains the procedures to upgrade the SHDSL line card's firmware version; the higher version will bring new features and function of SHDSL LCs.

CLI employs a NE SHDSL Firmware Upgrade utility to transfer the new code files to the memory of NC card by FTP, and then upgrade this new version from memory to SHDSL line card, follow the below procedures to update your SHDSL line card if necessary.

First, open the DOS prompt window and go to the directory where the new firmware is, then upload the new SHDSL firmware to flash memory through FTP.

3 shows how to upload firmware to memory.

The username/password of FTP is admin/admin.

Second, use the commands described in Table 3-23 to upgrade the new firmware to SHDSL line card. Wait for the state of upgrade becomes "finished".

### Example 12 Upload SHDSL Firmware to Flash Memory through FTP

```
D:\image\SHDSL Firmware>ftp 10.12.3.97
Connected to 10.12.3.97.
220-=====
220-      Welcome to the IP-DSLAM FTP Server      -
220-      -
220- CAUTION: It's your responsibility to use the FTP service correctly -
220-      , please put the right files into the right file system. -
220 =====
User (10.12.3.97:(none)): admin
331 Password required
Password:
230 User logged in
ftp>
ftp> cd shdsl:
250 Changed directory to "shdsl:/"
ftp> put TEImage.bin.gz
200 Port set okay
150 Opening BINARY mode data connection
226- CAUTION:Please wait for 120 seconds or check the Flash LED -
226 Transfer complete
ftp: 1834196 bytes sent in 1.30Seconds 1414.18Kbytes/sec.
ftp>
ftp> bye
221 Bye...see you later
```

**Table 3-23 SHDSL Firmware Upgrade**

Use this command to upgrade SHDSL firmware from flash memory to SHDSL line card.	
<b>CLI# shdsl-fw-upgrade start &lt;lc-range&gt;</b>	
Use this command to show the upgrade status.	
<b>CLI# shdsl-fw-upgrade show</b>	
Parameters	Task
<lc-range>	This specifies the slot index of target SHDSL line card. <b>Type:</b> Mandatory

Use this command to upgrade SHDSL firmware from flash memory to SHDSL line card.	
<b>CLI# shdsl-fw-upgrade start &lt;lc-range&gt;</b>	
	Valid values: 1 ~ 4

**Example 13 Upload SHDSL Firmware to Line Card through FTP**

```

CLI# shdsl-fw-upgrade start 4
OK: Please reset LC after "finished" state

CLI# shdsl-fw-upgrade show

SHDSL firmware upgrade state
LC type      state
-----
1 ADSL          n/a
2 ADSL          n/a
3 ADSL          n/a
4 SHDSL transmission of firmware image
    
```

**Ambient Temperature**

Use “**sensorthreshold**” command under “**config**” group directory to set the temperature threshold of hardware sensor of DAS4672.

Enter to the “**config sensorthreshold**” sub-group directory to operation.

```

CLI# config sensorthreshold
CLI(HW-SENSOR)#
    
```

**Table 3-24 Configuring Ambient Temperature**

Use this command to set the temp threshold of whole system.	
<b>CLI(HW-SENSOR)# set temp &lt;temp-high&gt; &lt;temp-low&gt;</b>	
Use this command to show the current setting.	
<b>CLI(HW-SENSOR)# show</b>	
Parameters	Task
<temp-high>	This specifies the high temperature to trigger the alarm transmit. <b>Type:</b> Mandatory <b>Valid values:</b> -20 ~ 100 (degrees centigrade)
<temp-low>	This specifies the low temperature to trigger the alarm transmit. <b>Type:</b> Mandatory <b>Valid values:</b> -20 ~ 100 (degrees centigrade)

**Checking the SFP module information**

DAS4672 IP-DSLAM support up to 2 SFP (Small Form Pluggable) Mini-GBIC module.

Use the “**gbic show**” command under the “**status**” group directory to display the SFP information, each plug-in SFP module.

Enter to the “**status**” group directory to verify the SFP module information.

```
CLI# status
CLI(STATUS)#
```

**Table 3-25** Checking the SFP module information

Using this command to display the system plugged SFP mini GBIC module.	
<b>CLI(STATUS)# gbic show</b> <i>&lt;uge-id&gt;</i>	
Parameters	Task
<i>&lt;uge-id&gt;</i>	This specifies the index of UGE. <b>Type:</b> Mandatory <b>Valid values:</b> 1   2

## Chapter 4 Managing the System Profiles

---

This chapter explains how to use profile feature to create and manage profiles for your DAS4672 IP-DSLAM.

This chapter contains the following sections:

- Overview of System Profile
- Managing the ADSL Performance Alarm Profile
- Managing the SHDSL Performance Alarm Profile
- Managing the ADSL Port Connection Profile
- Managing the SHDSL Port Connection Profile
- Managing the IP Traffic Profile
- Managing the Traffic Policing Profile
- Managing the Multicast Service Profile

### Overview of System Profile

The system profile feature allows you to create and manage of ADSL PM Alarm profile, ADSL port connection profile, IP traffic profile, and multicast group profile for your DAS4672 IP-DSLAM. These profiles enable you to use on the different ADSL line port and data connection, each of which requires different configuration settings. For example, you may want to set up profiles for using your ADSL line port at the home user, small office user, and in enterprise customer such as bank. They may require the different line speed and performance monitoring to secure the service quality. Once the profiles are created, you can easily assign or modify between them without having to reconfigure your ADSL line port each time you face a new connection.

A profile is a named list of configuration parameters with a value assigned to each parameter. When you delete a profile you will affect the change on all ports using that profile. If you want to change a single port or a subset of ports, you can create another profile with desired parameters, and then assign the new profile to the desired port.

Two types of profiles are enclosing with the ADSL line port, which are Performance Alarm Profile and Port Connection Profile. The Multicast Group Profile is used with the multicast service which contains management of channel profile and services profile, while IP traffic profile manages the traffic bandwidth of Unicast connection.

### Managing the ADSL Performance Alarm Profile

---

---

---

---

---

---

---

---

---

---

Use performance monitoring (PM) parameter to gather, store, threshold, and alarm report performance data for early detection of ADSL line port problems.

Create a performance alarm profile to define the Near-End and Far-End threshold conditions in 15 minutes and 1 day interval. The thresholds are used to set error levels for each PM. You can program PM threshold ranges such as ES (Errored Seconds), SES (Severely Errored Seconds), and UAS (Unavailable Seconds).

During the accumulation cycle, if the current value of a performance monitoring parameter reaches or exceeds its corresponding threshold value, a threshold crossing alert (TCA) is generated by the system and sent to trap station. TCAs provide early detection of performance degradation. When a threshold is crossed, the ADSL line port continues to count the errors during a given accumulation period. If 0 is entered as the threshold value, the PM parameter is disabling.

A of profile corresponds to a particular set of parameters, and can be referenced to by separate ADSL line port.

Enter to the “**config profile adsl-alarm**” sub-group directory to manage the ADSL performance alarm profile.

```
CLI# config profile adsl-alarm
```

```
CLI(config profile adsl-alarm)#
```

**Table 4-26 ADSL Performance Alarm Profile Configuration**

Use this command to generate a new ADSL performance alarm profile.	
<b>CLI(config profile adsl-alarm)# add</b> <profile-name>	
Use this command to remove the specific ADSL performance alarm profile.	
<b>CLI(config profile adsl-alarm)# del</b> <profile-name>	
Use this command to activate the specific ADSL performance alarm profile.	
<b>CLI(config profile adsl-alarm)# enable</b> <profile-name>	
Use this command to deactivate the specific ADSL performance alarm profile.	
<b>CLI(config profile adsl-alarm)# disable</b> <profile-name>	
Use this command to modify the performance ADSL alarm profile parameters at Near-End and Far-End.	
<b>CLI(config profile adsl-alarm)# set</b> <profile-name> <15min-es> <15min-ses> <15min-uas> <1day-es> <1day-ses> <1day-uas> [near   far]	
Use this command to monitor the ADSL performance alarm profile information.	
<b>CLI(config profile adsl-alarm)# show</b> [<profile-name>]	
Parameters	Task
<profile-name>	This specifies the performance alarm profile name <b>Type:</b> Mandatory <b>Valid values:</b> String of up to 32 characters ('0'-'9', 'A'-'Z', 'a'-'z', '-', '_', '!', '@').
<15min-es>	The 15 minutes Errored Seconds (ES), this indicates that a count of 1-second intervals with one or more CRC-8 anomalies summed over all received bearer channels, or one or more LOS defects, or one or more SEF defects, or one or more LPR defects. <b>Type:</b> Mandatory <b>Valid values:</b> 0 ~ 900 <b>Default value:</b> 0 (due to profile generated)

**Table 4-1 ADSL Performance Alarm Profile Configuration (Continued)**

Parameters	Task
<15min-ses>	The 15 minutes Severely Errored Seconds (SES), this indicates that a count of 1-second intervals contains 18 or more CRC-8 anomalies summed over all received bearer channels, or one or more LOS defects, or one or more SEF defects, or one or more LPR defects. <b>Type:</b> Mandatory <b>Valid values:</b> 0 ~ 900 <b>Default value:</b> 0 (due to profile generated)
<15min-uas>	The 15 minutes Unavailable Seconds (UAS), this indicates that a count of 1-second intervals for which the ADSL line is unavailable. The ADSL line becomes unavailable at the onset of 10 contiguous SES. The 10 SES are included in unavailable time. Once unavailable, the ADSL line becomes available at the onset of 10 contiguous seconds with no SES. The 10 seconds with no SES are excluded from unavailable time. <b>Type:</b> Mandatory <b>Valid values:</b> 0 ~ 900 <b>Default value:</b> 0 (due to profile generated)
<1day-es>	The 1 day Errored Seconds (ES), this indicates that a count of 1-second intervals contains one or more CRC-8 anomalies summed over all received bearer channels, or one or more LOS defects, or one or more SEF defects, or one or more LPR defects. <b>Type:</b> Mandatory <b>Valid values:</b> 0 ~ 86400 <b>Default value:</b> 0 (due to profile generated)
<1day-ses>	The 1 day Severely Errored Seconds (SES), this indicates that a count of 1-second intervals contains 18 or more CRC-8 anomalies summed over all received bearer channels, or one or more LOS defects, or one or more SEF defects, or one or more LPR defects. <b>Type:</b> Mandatory <b>Valid values:</b> 0 ~ 86400 <b>Default value:</b> 0 (due to profile generated)
<1day-uas>	The 1 day Unavailable Seconds (UAS), this indicates that a count of 1-second intervals for which the ADSL line is unavailable. The ADSL line becomes unavailable at the onset of 10 contiguous SES. The 10 SES are included in unavailable time. Once unavailable, the ADSL line becomes available at the onset of 10 contiguous seconds with no SES. The 10 seconds with no SES are excluded from unavailable time. <b>Type:</b> Mandatory <b>Valid values:</b> 0 ~ 86400 <b>Default value:</b> 0 (due to profile generated)
[near   far]	Identify the given PM value in Near-End or Far-End side, CLI Ex will apply the same PM value for Near-End and Far-End if not specify. <b>Type:</b> Optional <b>Valid values:</b> near, far

This example shows how to generate a new performance alarm profile with corresponding PM values, use “enable” command to activate the given profile.

**Example 14 Add a new performance alarm profile with correspond PM values**

```

CLI(config profile adsl-alarm)# add bank_pm
OK

CLI(config profile adsl-alarm)# set bank_pm 10 15 20 30 40 50
    
```

OK

CLI(config profile adsl-alarm)# **enable bank\_pm**

OK

CLI(config profile adsl-alarm)# **show**

profile [bank\_pm]: enabled

side-end	15min-es	15min-ses	15min-uas	1day-es	1day-ses	1day-uas
near end	10	15	20	30	40	50
far end	10	15	20	30	40	50

Attaching the performance alarm profile to the proper ADSL line port can be task at “**config port**” sub-group directory, refer to the “Chapter 5 Configuring the ADSL Line Port”.

## Managing the SHDSL Performance Alarm Profile

---



---



---



---



---



---



---



Enter to the “**config shdsl profile alarm**” sub-group directory to manage the SHDSL performance alarm profile.

```
CLI# config shdsl profile alarm
CLI(SHPF-ALARM)#
```

**Table 4-27 SHDSL Performance Alarm Profile Configuration**

Use this command to generate a new SHDSL performance alarm profile.	
<b>CLI(SHPF-ALARM)# add</b> <profile name>	
Use this command to remove the specific SHDSL performance alarm profile.	
<b>CLI(SHPF-ALARM)# del</b> <profile name>	
Use this command to activate the specific SHDSL performance alarm profile.	
<b>CLI(SHPF-ALARM)# enable</b> <profile name>	
Use this command to deactivate the specific SHDSL performance alarm profile.	
<b>CLI(SHPF-ALARM)# disable</b> <profile name>	
Use this command to modify the SHDSL performance alarm profile parameters at Near-End.	
<b>CLI(SHPF-ALARM)# set</b> <profile name> [ <b>atte</b> <atte> <b>snr</b> <snr> <b>es</b> <es> <b>ses</b> <ses> <b>crc</b> <crc> <b>losws</b> <losws> <b>uas</b> <usa>]	
Use this command to monitor the SHDSL performance alarm profile information.	
<b>CLI(SHPF-ALARM)# show</b> <profile name>	
Parameters	Task
<profile name>	This specifies the performance alarm profile name <b>Type:</b> Mandatory <b>Valid values:</b> String of up to 32 characters ('0'-'9', 'A'-'Z', 'a'-'z', '-', '_', '!', '@').
<atte>	This identifies the attenuation threshold. <b>Type:</b> Mandatory <b>Valid values:</b> 1 ~ 127
<es>	The 15 minutes Errored Seconds (ES), this indicates that a count of 1-second intervals with one or more CRC-8 anomalies summed over all received bearer channels, or one or more LOS defects, or one or more SEF defects, or one or more LPR defects. <b>Type:</b> Mandatory <b>Valid values:</b> 0 ~ 900 <b>Default value:</b> 0 (due to profile generated)
<ses>	The 15 minutes Severely Errored Seconds (SES), this indicates that a count of 1-second intervals contains 18 or more CRC-8 anomalies summed over all received bearer channels, or one or more LOS defects, or one or more SEF defects, or one or more LPR defects. <b>Type:</b> Mandatory <b>Valid values:</b> 0 ~ 900 <b>Default value:</b> 0 (due to profile generated)
<crc>	This identifies the CRC error threshold. <b>Type:</b> Mandatory <b>Valid values:</b> 0 ~ 44100
<losws>	This identifies the LOSWS error threshold. <b>Type:</b> Mandatory <b>Valid values:</b> 0 ~ 900
<losws>	This identifies the LOSWS error threshold. <b>Type:</b> Mandatory <b>Valid values:</b> 0 ~ 900
<usa>	The 15 minutes Unavailable Seconds (UAS), this indicates that a count of 1-second intervals for which the ADSL line is unavailable. The ADSL line becomes unavailable at the onset of 10 contiguous SES. The 10 SES are included in unavailable time. Once unavailable, the ADSL line becomes available at the onset of 10 contiguous seconds with no SES. The 10 seconds with no SES are excluded from unavailable time. <b>Type:</b> Mandatory <b>Valid values:</b> 0 ~ 900 <b>Default value:</b> 0 (due to profile generated)

## Managing the ADSL Port Connection Profile

The ADSL port connection profile indicates the expected overall physical parameters of the ADSL line port. This profile describes the communication at the ADSL layer. A number of parameters will be specified such as fast/interleaved, rate adaptation mode, noise margin, power spectrum density, and transmit rate.

A profile corresponds to a particular set of parameters, and can be referenced to by separate ADSL line port.

Enter to the “**config profile adsl-conf**” sub-group directory to manage the ADSL port connection profile.

```
CLI# config profile adsl-conf
CLI(config profile adsl-conf)#
```

**Table 4-28 ADSL Port Connection Profile Configuration**

Use this command to generate a new ADSL port connection profile.
<b>CLI(config profile adsl-conf)# add</b> <i>&lt;profile-name&gt;</i>
Use this command to remove the specific ADSL port connection profile.
<b>CLI(config profile adsl-conf)# del</b> <i>&lt;profile-name&gt;</i>
Use this command to activate the specific ADSL port connection profile.
<b>CLI(config profile adsl-conf)# enable</b> <i>&lt;profile-name&gt;</i>
Use this command to deactivate the specific ADSL port connection profile.
<b>CLI(config profile adsl-conf)# disable</b> <i>&lt;profile-name&gt;</i>
Use this command to modify the profile rate mode to adaptive with desired parameters.
<b>CLI(config profile adsl-conf)# set adaptive-rate</b> <i>&lt;profile-name&gt;</i> <i>&lt;us-min-rate&gt;</i> <i>&lt;us-max-rate&gt;</i> <i>&lt;ds-min-rate&gt;</i> <i>&lt;ds-max-rate&gt;</i>
Use this command to modify the profile rate mode to dynamic with desired parameters.
<b>CLI(config profile adsl-conf)# set dynamic-rate</b> <i>&lt;profile-name&gt;</i> <i>&lt;us-min-rate&gt;</i> <i>&lt;us-max-rate&gt;</i> <i>&lt;ds-min-rate&gt;</i> <i>&lt;ds-max-rate&gt;</i> <i>&lt;us-down-shift&gt;</i> <i>&lt;us-up-shift&gt;</i> <i>&lt;ds-down-shift&gt;</i> <i>&lt;ds-up-shift&gt;</i>
Use this command to modify the profile rate mode to fixed with desired parameters.
<b>CLI(config profile adsl-conf)# set fixed-rate</b> <i>&lt;profile-name&gt;</i> <i>&lt;us-rate&gt;</i> <i>&lt;ds-rate&gt;</i>
Use this command to modify the profile line mode to interleaved path with latency.
<b>CLI(config profile adsl-conf)# set line-mode</b> <i>&lt;profile-name&gt;</i> <b>interleave</b> <i>&lt;max-us-latency&gt;</i> <i>&lt;max-ds-latency&gt;</i> <i>&lt;min-us-inp&gt;</i> <i>&lt;min-ds-inp&gt;</i>
Use this command to modify the profile line mode to fast path.
<b>CLI(config profile adsl-conf)# set linemode</b> <i>&lt;profile-name&gt;</i> <b>fast</b>
Use this command to modify the profile PSD (Power Spectrum Density) with desired parameters.
<b>CLI(config profile adsl-conf)# set psd</b> <i>&lt;profile-name&gt;</i> <i>&lt;us-psd&gt;</i> <i>&lt;ds-psd&gt;</i>
Use this command to modify the SNR (Signal Noise Ratio) margin of downstream.
<b>CLI(config profile adsl-conf)# set snr</b> <i>&lt;profile-name&gt;</i> <b>ds</b> <i>&lt;target-snr-mgn&gt;</i> <i>&lt;min-snr-mgn&gt;</i> <i>&lt;max-snr-mgn&gt;</i>
Use this command to modify the SNR (Signal Noise Ratio) margin of upstream.
<b>CLI(config profile adsl-conf)# set snr</b> <i>&lt;profile-name&gt;</i> <b>us</b> <i>&lt;target-snr-mgn&gt;</i> <i>&lt;min-snr-mgn&gt;</i> <i>&lt;max-snr-mgn&gt;</i>
Use this command to modify the downstream shelf SNR margin due to dynamic rate mode.
<b>CLI(config profile adsl-conf)# set shift-snr</b> <i>&lt;profile-name&gt;</i> <b>ds</b> <i>&lt;down-shift-snr&gt;</i> <i>&lt;up-shift-snr&gt;</i>
Use this command to modify the upstream shelf SNR margin due to dynamic rate mode.

Use this command to generate a new ADSL port connection profile.
<b>CLI(config profile adsl-conf)# add</b> <profile-name>
Use this command to remove the specific ADSL port connection profile.
<b>CLI(config profile adsl-conf)# del</b> <profile-name>
Use this command to activate the specific ADSL port connection profile.
<b>CLI(config profile adsl-conf)# enable</b> <profile-name>
Use this command to deactivate the specific ADSL port connection profile.
<b>CLI(config profile adsl-conf)# disable</b> <profile-name>
<b>CLI(config profile adsl-conf)# set shift-snr</b> <profile-name> <b>us</b> <down-shift-snr> <up-shift-snr>
Use this command to modify the ADSL2/ADSL2+ power management for L2 state.
<b>CLI(config profile adsl-conf)# set pwr-mgt</b> <profile-name> <b>I2</b> <mode> <l2-min-rate> <l2-max-rate> <l2-low-rate-time> <l0-time>
Use this command to modify the ADSL2/ADSL2+ power management for L3 state.
<b>CLI(config profile adsl-conf)# set pwr-mgt</b> <profile-name> <b>I3</b> <denied   accepted>
Use this command to monitor the ADSL port connection profile information.
<b>CLI(config profile adsl-conf)# show</b> [<profile-name>]

Parameters	Task
<profile-name>	This specifies the ADSL port connection profile name <b>Type:</b> Mandatory <b>Valid values:</b> String of up to 32 characters ('0'~'9', 'A'~'Z', 'a'~'z', '-', '_', ':', '@').
<us-min-rate>	Defines upstream minimum transmit rate, this parameter is available for adaptive and dynamic rate mode. <b>Type:</b> Mandatory <b>Valid values:</b> 64 ~ 2976 (multiple of 32 kbps) <b>Default value:</b> 64 kbps (due to profile generated)
<us-max-rate>	Defines upstream maximum transmit rate, this parameter is available for adaptive and dynamic rate mode. <b>Type:</b> Mandatory <b>Valid values:</b> 64 ~ 2976 (multiple of 32 kbps) <b>Default value:</b> 64 kbps (due to profile generated)
<ds-min-rate>	Defines downstream minimum transmit rate, this parameter is available for adaptive and dynamic rate mode. <b>Type:</b> Mandatory <b>Valid values:</b> 64 ~ 29984 (multiple of 32 kbps) <b>Default value:</b> 64 kbps (due to profile generated)
<ds-max-rate>	Defines downstream maximum transmit rate, this parameter is available for adaptive and dynamic rate mode. <b>Type:</b> Mandatory <b>Valid values:</b> 64 ~ 29984 (multiple of 32 kbps) <b>Default value:</b> 64 kbps (due to profile generated)
<us-rate>	Defines upstream transmit rate, this parameter is available for fixed rate mode. <b>Type:</b> Mandatory <b>Valid values:</b> 64 ~ 2976 (multiple of 32 kbps) <b>Default value:</b> 64 kbps (due to profile generated)
<ds-rate>	Defines downstream transmit rate, this parameter is available for fixed rate mode. <b>Type:</b> Mandatory <b>Valid values:</b> 64 ~ 29984 (multiple of 32 kbps) <b>Default value:</b> 64 kbps (due to profile generated)

Table 4-3 ADSL Port Connection Profile Configuration (Continued)

Parameters	Task
< us-down-shift >	Defines upstream down-shift margin time interval due to dynamic rate of seamless adaptation action. <b>Type:</b> Mandatory <b>Valid values:</b> 0 ~ 16384 (seconds) <b>Default value:</b> 0 sec (due to profile generated)
< us-up-shift >	Defines upstream up-shift margin time interval due to dynamic rate of seamless adaptation action. <b>Type:</b> Mandatory <b>Valid values:</b> 0 ~ 16384 (seconds) <b>Default value:</b> 0 sec (due to profile generated)
< ds-down-shift >	Defines downstream down-shift margin time interval due to dynamic rate of seamless adaptation action. <b>Type:</b> Mandatory <b>Valid values:</b> 0 ~ 16384 (seconds) <b>Default value:</b> 0 sec (due to profile generated)
< ds-up-shift >	Defines downstream up-shift margin time interval due to dynamic rate of seamless adaptation action. <b>Type:</b> Mandatory <b>Valid values:</b> 0 ~ 16384 (seconds) <b>Default value:</b> 0 sec (due to profile generated)
< max-us-latency >	Defines upstream interleaved path latency. <b>Type:</b> Mandatory <b>Valid values:</b> 1 ~ 255 (milliseconds) <b>Default value:</b> 0 msec (due to profile generated)
< max-ds-latency >	Defines downstream interleaved path latency. <b>Type:</b> Mandatory <b>Valid values:</b> 1 ~ 255 (milliseconds) <b>Default value:</b> 0 msec (due to profile generated)
< min-us-inp >	Defines upstream minimum protection symbol time, <b>Type:</b> Mandatory <b>Valid values:</b> {0   1/2   1   2   4   8   16} <b>Default value:</b> 0 (due to profile generated)
< min-ds-inp >	Defines downstream minimum protection symbol time. <b>Type:</b> Mandatory <b>Valid values:</b> {0   1/2   1   2   4   8   16} <b>Default value:</b> 0 (due to profile generated)
< us-psd >	Defines upstream power spectrum density level. <b>Type:</b> Mandatory <b>Valid values:</b> -40.0 ~ 4.0 (dB/Hz) <b>Default value:</b> 0 dB/Hz (due to profile generated)
< ds-psd >	Defines downstream power spectrum density level. <b>Type:</b> Mandatory <b>Valid values:</b> -40.0 ~ 4.0 (dB/Hz) <b>Default value:</b> 1.0 dB/Hz (due to profile generated)
< target-snr-mgn >	Defines target SNR margin for upstream or downstream signal. <b>Type:</b> Mandatory <b>Valid values:</b> 0.0 ~ 31.0 (dBm) <b>Default value:</b> 6.0 dBm (due to profile generated)
< min-snr-mgn >	Defines minimum SNR margin for upstream or downstream signal. <b>Type:</b> Mandatory <b>Valid values:</b> 0.0 ~ 31.0 (dBm) <b>Default value:</b> 0 dBm (due to profile generated)
< max-snr-mgn >	Defines maximum SNR margin for upstream or downstream signal. <b>Type:</b> Mandatory <b>Valid values:</b> 0.0 ~ 31.0 (dBm) <b>Default value:</b> 31.0 dBm (due to profile generated)

**Table 4-3 ADSL Port Connection Profile Configuration (Continued)**

Parameters	Task
<down-shift-snr>	Defines down-shift SNR margin for upstream or downstream signal. <b>Type:</b> Mandatory <b>Valid values:</b> 0.0 ~ 31.0 (dBm) <b>Default value:</b> 0 dBm (due to profile generated)
<up-shift-snr>	Defines up-shift SNR margin for upstream or downstream signal. <b>Type:</b> Mandatory <b>Valid values:</b> 0.0 ~ 31.0 (dBm) <b>Default value:</b> 0 dBm (due to profile generated)
<mode>	Defines power management mode <b>Type:</b> Mandatory <b>Valid values:</b> {automatic   manual} <b>Default value:</b> manual
<l2-min-rate>	Defines minimum and low-bound for L2 state in 32 kbps steps. <b>Type:</b> Mandatory <b>Valid values:</b> 32 ~ 29984 kbps <b>Default value:</b> 64 kbps
<l2-max-rate>	Defines maximum data rate for L2 state in 32 kbps steps. <b>Type:</b> Mandatory <b>Valid values:</b> 32 ~ 29984 kbps <b>Default value:</b> 29984 kbps
<l2-low-rate-time>	Defines continuous time (sec.) of rate lower than L2 low-bound <b>Type:</b> Mandatory <b>Valid values:</b> 0 ~ 65535 seconds <b>Default value:</b> 300 seconds
<l0-time>	Defines minimum time (sec.) in L0 state to check L2 criteria <b>Type:</b> Mandatory <b>Valid values:</b> 0 ~ 65535 seconds <b>Default value:</b> 900 seconds
<denied   accepted>	Defines the IP-DSLAM to allow L3 command from CPE site or not. <b>Type:</b> Mandatory <b>Valid values:</b> {denied   accepted} <b>Default value:</b> accepted

This example shows how to generate a new ADSL port connection profile with desired parameters, use “enable” command to activate the given profile.

**Example 15 Add a new ADSL port connection profile with desired values**

```

CLI(config profile adsl-conf)# add bank
OK
CLI(config profile adsl-conf)# set adaptive-rate bank 512 2048 1024 8192
OK
CLI(config profile adsl-conf)# set line-mode bank interleave 10 10 1 1
OK
CLI(config profile adsl-conf)# enable bank
OK
CLI(config profile adsl-conf)# show bank

profile [bank]
  status      : enabled
  line mode   : interleave
  rate mode   : adaptive
                up-stream  down-stream
                -----  -----
  fast rate (min/max) : 512/2048  1024/8192 kbps
    
```

```

interleave rate (min/max)   : 512/2048 1024/8192 kbps
interleave max delay       : 10      10 ms
interleave min INP symbol time : 1      1
target SNR margin         : 6.0      6.0 dB
min./max. SNR margin       : 0.0/31.0 0.0/31.0 dB
down/up shift SNR margin   : 3.0/20.0 3.0/20.0 dB
down/up shift time         : 1000/1000 1000/1000 sec
PSD                        : 0.0      0.0 dBm/Hz
power management setting:
  L2-mode L2-min-rate L2-max-rate CPE L3
-----
manual 32 kbps 29984 kbps accepted

```

Attaching the ADSL port connection profile to the proper ADSL line port can be task at “**config port**” sub-group directory, refer to the “*Chapter 5 Configuring the ADSL Line Port*”.

## Managing the SHDSL Port Connection Profile

Enter to the “**config shdsl profile conf**” sub-group directory to manage the SHDSL port connection profile.

```

CLI# config shdsl profile conf
CLI(SHPF-CFG)#

```

**Table 4-29** SDLSL Port Connection Profile Configuration

Use this command to generate a new SHDSL port connection profile.	
<b>CLI(SHPF-CFG)# add</b> <profile-name>	
Use this command to remove the specific SHDSL port connection profile.	
<b>CLI(SHPF-CFG)# del</b> <profile-name>	
Use this command to activate the specific SHDSL port connection profile.	
<b>CLI(SHPF-CFG)# enable</b> <profile-name>	
Use this command to deactivate the specific SHDSL port connection profile.	
<b>CLI(SHPF-CFG)# disable</b> <profile-name>	
Use this command to modify the profile rate mode to adaptive with desired parameters.	
<b>CLI(SHPF-CFG)# set</b> <profile-name> [ <b>minrate</b> <minrate> <b>maxrate</b> <maxrate> <b>psd</b> <psd> <b>transmission</b> <transmission> <b>downcurrentsnr</b> <downcurrentsnr> <b>downworstsnr</b> <downworstsnr> <b>upcurrentsnr</b> <upcurrentsnr> <b>upworstsnr</b> <upworstsnr> <b>usedsnr</b> <usedsnr> <b>lineprobe</b> <lineprobe>]	
Use this command to monitor the SHDSL port connection profile information.	
<b>CLI(SHPF-CFG)# show</b> [<profile name>]	
Parameters	Task
<profile name>	This specifies the SHDSL port connection profile name <b>Type:</b> Mandatory <b>Valid values:</b> String of up to 32 characters ('0'~'9', 'A'~'Z', 'a'~'z', '-', '_', '!', '@').
<minrate>	Defines minimum transmit rate, this parameter is available for adaptive and dynamic rate mode. <b>Type:</b> Mandatory <b>Valid values:</b> 72 ~ 2312 (multiple of 64 kbps) <b>Default value:</b> 72 kbps (due to profile generated)
<maxrate>	Defines maximum transmit rate, this parameter is available for adaptive and dynamic rate mode. <b>Type:</b> Mandatory <b>Valid values:</b> 72 ~ 2312 (multiple of 64 kbps)

Use this command to generate a new SHDSL port connection profile.	
<b>CLI(SHPF-CFG)# add</b> <profile-name>	
Use this command to remove the specific SHDSL port connection profile.	
<b>CLI(SHPF-CFG)# del</b> <profile-name>	
Use this command to activate the specific SHDSL port connection profile.	
	<b>Default value:</b> 72 kbps (due to profile generated)
<psd>	Defines power spectrum density level. <b>Type:</b> Mandatory <b>Valid values:</b> 1 = symmetric, 2 = asymmetric <b>Default value:</b> 1

**Table 4-29 SDSL Port Connection Profile Configuration (Continued)**

Parameters	Task
<transmission>	Defines the transmission mode, Annex A, Annex B, or both. <b>Type:</b> Mandatory <b>Valid values:</b> 1:Annex.A or 2:Annex.B or 3:Both. <b>Default value:</b> 3
<downcurrentsnr >	Defines downstream current target SNR margin. <b>Type:</b> Mandatory <b>Valid values:</b> -10 ~ 21 (dBm) <b>Default value:</b> 6 dBm (due to profile generated)
<downworstsnr >	Defines downstream worst target SNR margin <b>Type:</b> Mandatory <b>Valid values:</b> -10 ~ 21 (dBm) <b>Default value:</b> 6 dBm (due to profile generated)
<upcurrentsnr>	Defines upstream current target SNR margin. <b>Type:</b> Mandatory <b>Valid values:</b> -10 ~ 21 (dBm) <b>Default value:</b> 6 dBm (due to profile generated)
<upworstsnr>	Defines upstream worst target SNR margin <b>Type:</b> Mandatory <b>Valid values:</b> -10 ~ 21 (dBm) <b>Default value:</b> 6 dBm (due to profile generated)
<usedsnr>	Defines used SNR bit-map, 0:down-current, 1:down-worst, 2:up-current, 3:up-worst <b>Type:</b> Mandatory <b>Valid values:</b> 0, 1, 2, 3
<lineprobe>	Enable or disable the line probe support. 1 = enable, 2 = disable. <b>Type:</b> Mandatory <b>Valid values:</b> 1, 2

## Managing the IP Traffic Profile

The IP traffic profile configure the bandwidth of subscriber connection traffic, you can manage the upstream rate and downstream rate, respectively. Once the stream rate defined, the subscriber traffic gets limited, moreover, the priority options provides efficiency of traffic forwarding due to congestion.

Enter to the “**config profile ip-traffic**” sub-group directory to manage the IP traffic profile.

```
CLI# config profile ip-traffic
CLI(config profile ip-traffic)#
```

**Table 4-30 IP Traffic Profile Configuration**

Use this command to generate a new IP traffic profile.	
<b>CLI(config profile ip-traffic)# add &lt;name&gt;</b>	
Use this command to remove a new IP traffic profile.	
<b>CLI(config profile ip-traffic)# del &lt;name&gt;</b>	
Use this command to configure the rate limit of specific IP traffic profile.	
<b>CLI(config profile ip-traffic)# set &lt;name&gt; &lt;us-rate-limit&gt; &lt;ds-rate&gt; &lt;ds-priority&gt; &lt;bcast-filter&gt;</b>	
Use this command to display the IP traffic profile information.	
<b>CLI(config profile ip-traffic)# show</b>	
Parameters	Task
<name>	This specifies the IP traffic profile name <b>Type:</b> Mandatory <b>Valid values:</b> String of up to 32 characters ('0'-'9', 'A'-'Z', 'a'-'z', '-', '_', '.', '@').
<us-rate-limit>	This specifies the upstream rate limit for subscriber IP traffic. <b>Type:</b> Mandatory <b>Valid values:</b> nolimit   32k   64k   128k   256k   384k   512k   768k
<ds-rate>	This specifies the downstream rate limit for subscriber IP traffic. <b>Type:</b> Mandatory <b>Valid values:</b> 0 ~ 29984 kbps (multiple of 32 kbps)
<ds-priority>	This defines the downstream priority, the lower the priority, the higher the chance to get drop due to traffic congestion. <b>Type:</b> Mandatory <b>Valid values:</b> low   medium   high   highest
<bcast-filter>	This defines the downstream broadcast filter of ip-traffic profile. Available on the VLAN ID in which PVC used this ip-traffic. <b>Type:</b> Mandatory <b>Valid values:</b> drop   forward

## Managing the Traffic Policing Profile

According to SLA (Service Level Agreements) between subscribers and ISP, the edge network equipment marks subscriber's traffic with different service level. The traffic policing profile serves to keep the rule to re-mark the subscriber's upstream traffic with designated DSCP values. The traffic policing profile is design to police on the unicast connection for user's upstream traffic; once it is created you can apply it to distinct xDSL line interfaces (see Chapter 5 Configuring the ADSL Line Port).

The CIR(Commit Information Rate) define the upstream rate police to be forwarded. The Action defines action (either DSCP replacement or no action) applied to the traffic over CIR.

Enter to the “**config profile metering**” sub-group directory to manage the traffic policing profile.

```
CLI# config profile metering
CLI(config profile metering)#
```

**Table 4-31 Traffic Policing Profile Configuration**

Use this command to generate a new traffic policing profile.	
<b>CLI(config profile metering)# add &lt;profile-name&gt;</b>	
Use this command to remove the specific traffic policing profile.	
<b>CLI(config profile metering)# del &lt;profile-name&gt;</b>	
Use this command to modify the traffic policing profile and it desired parameters.	
<b>CLI(config profile metering)# set &lt;profile-name&gt; &lt;cir&gt; &lt;action&gt;</b>	



Use this command to generate a new traffic policing profile.	
<b>CLI(config profile metering)# add</b> <profile-name>	
Use this command to remove the specific traffic policing profile.	
<b>CLI(config profile metering)# del</b> <profile-name>	
Use this command to monitor the traffic policing profile information.	
<b>CLI(config profile metering)# show</b> [<profile-name>]	
Parameters	Task
<profile-name>	This specifies the traffic policing profile name <b>Type:</b> Mandatory <b>Valid values:</b> String of up to 32 characters ('0'~'9', 'A'~'Z', 'a'~'z', '-', '_', '.', '@').
<cir>	Defines the committed information rate of traffic policing profile. <b>Type:</b> Mandatory <b>Valid values:</b> 1 ~ 1000 (mbps)
<action>	This identifies which value will DSCP be replace, drop packets or do nothing when user's upstream traffic exceeds CIR. <b>Type:</b> Mandatory <b>Valid values:</b> no-action   drop   BE   AF11   AF12   AF13   AF21   AF22   AF23   AF31   AF32   AF33   AF41   AF42   AF43   EF



The Service Type Control shall be enabled when Traffic Policing Profile is assign to xDSL subscribers (refer to Chapter 5 Configuring the ADSL Line Port).



Please refer to Figure 8-5 for more details of Differentiated Service Code Point.

## Managing the Multicast Service Profile

The multicast service profile embraces a number of multicast channel profiles. The multicast channel profile controls transmission rate and priority of multicast stream. Multicast channel uses class D addressing, which is a special form of the IP address designed for multicasting.

### Multicast Channel Profile Setting

The multicast channel profile is the connection link base, configure on single channel (multicast class D IP address) to define the bandwidth (rate) and priority level.

Enter to the “**config profile mcast**” sub-group directory to manage the multicast channel profile.

```
CLI# config profile mcast
CLI(config profile mcast)#
```

**Table 4-32 Multicast Channel Profile Configuration**

Use this command to generate a new multicast group profile.	
<b>CLI(config profile mcast)# add</b> <profile-name>	
Use this command to remove the specific multicast group profile.	
<b>CLI(config profile mcast)# del</b> <profile-name>	
Use this command to activate the specific multicast group profile.	
<b>CLI(config profile mcast)# enable</b> <profile-name>	
Use this command to deactivate the specific multicast group profile.	
<b>CLI(config profile mcast)# disable</b> <profile-name>	

Use this command to generate a new multicast group profile.	
<b>CLI(config profile mcast)# add</b> <profile-name>	
Use this command to remove the specific multicast group profile.	
<b>CLI(config profile mcast)# del</b> <profile-name>	
Use this command to activate the specific multicast group profile.	
Use this command to modify the profile multicast group member and it desired parameters.	
<b>CLI(config profile mcast)# set</b> <profile-name> <group-ip> <rate> {low   medium   high   highest}	
Use this command to monitor the multicast group profile information.	
<b>CLI(config profile mcast)# show</b> [<profile-name>]	
Parameters	Task
<profile-name>	This specifies the multicast channel profile name <b>Type:</b> Mandatory <b>Valid values:</b> String of up to 32 characters ('0'~'9', 'A'~'Z', 'a'~'z', '-', '_', '.', '@').
<group-ip>	Defines class D IP addressing for multicast channel. <b>Type:</b> Mandatory <b>Valid values:</b> 224.0.1.0 ~ 239.255.255.255 <b>Default value:</b> 0.0.0.0 (due to profile generated)
<rate>	Defines the downstream transmission limit rate of multicast channel. <b>Type:</b> Mandatory <b>Valid values:</b> 0 ~ 29984 kbps <b>Default value:</b> 32 kbps (due to profile generated)
{low   medium   high   highest}	Defines the forwarding priority <b>Type:</b> Mandatory <b>Valid values:</b> low, medium, high, highest <b>Default value:</b> low (due to profile generated)

## Multicast Service Profile Setting

The multicast service profile is a program list base, you can wrapped a sets of multicast channel profile to become a service program.

Attaching the multicast profile to the proper ADSL line port can be task at “**config mcau**” sub-group directory, refer to the “Chapter 7 Configuring the Multicast Services”.

Enter to the “**config profile mservice**” sub-group directory to manage the multicast service profile.

```
CLI# config profile mservice
```

```
CLI(config profile mservice)#
```

**Table 4-33 Multicast Service Profile Configuration**

Use this command to generate a new multicast service profile.	
<b>CLI(config profile mservice)# add</b> <service-name>	
Use this command to remove the specific multicast service profile.	
<b>CLI(config profile mservice)# del</b> <service-name>	
Use this command to add the multicast channel profile into specific multicast service profile.	
<b>CLI(config profile mservice)# subscribe</b> <service-name> <profile-list>	
Use this command to remove the multicast channel profile from specific multicast service profile.	
<b>CLI(config profile mservice)# cancel</b> <service-name> <profile-list>	
Use this command to monitor the multicast service profile information.	
<b>CLI(config profile mservice)# show</b>	

Use this command to generate a new multicast service profile.	
<b>CLI(config profile mservice)# add &lt;service-name&gt;</b>	
Use this command to remove the specific multicast service profile.	
Parameters	Task
<service-name>	This specifies the multicast service profile name <b>Type:</b> Mandatory <b>Valid values:</b> String of up to 32 characters ('0'~'9', 'A'~'Z', 'a'~'z', '-', '_', '!', '@').
<profile-list>	This specifies the multicast group profile name. <b>Type:</b> Mandatory <b>Valid values:</b> String of up to 32 characters ('0'~'9', 'A'~'Z', 'a'~'z', '-', '_', '!', '@'). <b>Format:</b> xxx or xxx xxx ... xxx (xxx indicate as multicast group profile)

This example shows how to generate a new multicast channel profile with desired parameters, use “enable” command to activate the given profile.

**Example 16 Create a new multicast channel profile with desired values**

```

CLI(config profile mcast)# add HBO
OK

CLI(config profile mcast)# add ESPN
OK

CLI(config profile mcast)# add CNN
OK

CLI(config profile mcast)# set HBO 224.1.1.10 29984 high
OK

CLI(config profile mcast)# set ESPN 224.1.1.11 29984 medium
OK

CLI(config profile mcast)# set CNN 224.1.1.12 29984 highest
OK

CLI(config profile mcast)# show
profile [HBO]
  group-ip   rate(kbps)  priority  status
  -----
  224.1.1.10  29984    high     disabled

profile [ESPN]
  group-ip   rate(kbps)  priority  status
  -----
  224.1.1.11  29984    medium   disabled

profile [CNN]
  group-ip   rate(kbps)  priority  status
  -----
  224.1.1.12  29984    highest  disabled
    
```

The below example shown how to subscribe (wrap) the created multicast channel profile into a complete service program.

**Example 17**Subscribe a sets of multicast channel into service profile

```
CLI(config profile mservice)# add program-1
```

```
OK
```

```
CLI(config profile mservice)# subscribe program-1 HBO|ESPN
```

```
OK
```

```
CLI(config profile mservice)# add program-2
```

```
OK
```

```
CLI(config profile mservice)# subscribe program-2 HBO|ESPN|CNN
```

```
OK
```

```
CLI(config profile mservice)# show
```

```
Profile [program-1]
```

```
  Mcast Profile: "HBO", "ESPN",
```

```
Profile [program-2]
```

```
  Mcast Profile: "HBO", "ESPN", "CNN",
```

## Chapter 5 Managing the Subscriber Interface

This chapter describes how to apply the relative profile to Subscriber interface.

This chapter contains the following sections:

- Configuring the ADSL Line Port
- Monitoring the ADSL Connection Status
- Configuring the SHDSL Line Port
- Monitoring the SHDSL Connection Status
- Subscriber Interface Administrating

### Configuring the ADSL Line Port

The ADSL port connection profile is independent and irrelative with other ADSL port interface. Configuration takes effect on specific port only.

Enter to the “**config port**” sub-group directory to configure the relative profile on the ADSL line port.

```
CLI# config port
CLI(config port)#
```

**Table 5-34 ADSL Port Interface Configuration**

Use this command to apply the PM alarm profile to specific ADSL line port.	
<b>CLI(config port)# set adsl-alarm-profile</b> <port-range> <name>	
Use this command to apply port connection profile to specific ADSL line port.	
<b>CLI(config port)# set adsl-conf-profile</b> <port-range> <name>	
Use this command to force the ADSL2/ADSL2+ power management status. (manual mode only)	
<b>CLI(config port)# set adsl-pwr-mgt</b> <port-range> <pwr-state>	
Use this command to apply the traffic policing profile to specific ADSL line port.	
<b>CLI(config port)# set metering</b> <port-range> <name>	
Use this command to apply a remote ID to specific xDSL line port.	
<b>CLI(config port)# set remote-id</b> <port-range> <idstring>	
Use this command to remove the remote ID from specific subscriber port.	
<b>CLI(config port)# clean remote-id</b> <port-range>	
Use this command to remove traffic policing profile from specific subscriber port.	
<b>CLI(config port)# clean metering</b> <port-range>	
Use this command to remove the PM alarm profile from specific subscriber port.	
<b>CLI(config port)# clean alarm-profile</b> <port-range>	
Use this command to viewing the ADSL line port operation status.	
<b>CLI(config port)# show</b> <port-range>	
Parameters	Task
<port-range>	Identify the port range of the system wish to apply the relevance profile of line port. <b>Type:</b> Mandatory <b>Valid values:</b> See “Chapter 2 Port Interface Indication”
<name>	Defines the profile name; port connection profile, performance alarm profile or

Use this command to apply the PM alarm profile to specific ADSL line port.	
<b>CLI(config port)# set adsl-alarm-profile</b> <port-range> <name>	
Use this command to apply port connection profile to specific ADSL line port.	
<b>CLI(config port)# set adsl-conf-profile</b> <port-range> <name>	
Use this command to force the ADSL2/ADSL2+ power management status. (manual mode only)	
	traffic policing profile. <b>Type:</b> Mandatory <b>Valid values:</b> The name of “port connection profile”, “performance alarm profile” or “traffic policing profile”
<pwr-state>	Defines the ADSL2/ADSL2+ power management operating status, switch between L0, L2 and L3 will only available if ADSL power management is in “Manual” mode. <b>Type:</b> Mandatory <b>Valid values:</b> L0, L2,L3
<idstring>	Identify the remote ID information.



The Service Type Control shall be enabled when Traffic Policing Profile is assign to xDSL subscribers (refer to Chapter 8 Card Module Operations).

### Example 18 Apply the profile to the specify of ADSL line port

```

CLI(config port)# set adsl-conf-profile 1.1.1 bank
OK

CLI(config port)# set adsl-alarm-profile 1.1.1 high-threshold
OK

CLI(config port)# set remote-id 1.1.1 1234
OK

CLI(config port)# set metering 1.1.1 policing-1
OK

CLI(config port)# show 1.1.1

port: 1.1.1
  admin status      : enabled
  oper status       : down
  cfg. profile      : "bank"
  alarm profile     : "high-threshold"
  traffic policing  : "policing-1"
  circuit ID        : "IP_DSLAM-100.168.3.97-00:00:00:00:00:00 atm 1/1:0.0"
  remote ID         : "1234"
  power state       : L0
  CPE wireless      : admin(disabled); oper(disabled)

```

## Monitoring the ADSL Connection Status

Enter to the “**status**” group directory to monitoring the ADSL line port connection status.

```

CLI# status
CLI(STATUS)#

```

**Table 5-35 ADSL Connection Status Monitor**

Use this command to viewing the ADSL line port connection status.	
<b>CLI(STATUS)# port show</b> <i>&lt;port-range&gt;</i> [ <i>phy</i>   <i>channel</i> ]	
Parameters	Task
<i>&lt;port-range&gt;</i>	Identify the port range of the system wish to view the status of line port. <b>Type:</b> Mandatory <b>Valid values:</b> See “Chapter 2 Port Interface Indication”
[ <i>phy</i>   <i>channel</i> ]	Defines the status of physical status or channel status, show both if not specify. <b>Type:</b> Optional <b>Valid values:</b> phy, channel

**Example 19 Display the ADSL Connection Status**

```

CLI(STATUS)# port show 1.1.1

port: 1.1
oper status      : up
power state      : L0
line standard    : G.992.5 Annex A

[physical status]
  item      US   DS
-----
attainable rate 1321 30515 kbps
attenuation     0.0 0.0 dB
SNR margin      6.7 33.1 dB
output power    12.1 8.9 dBm

[channel status]
  item      US   DS
-----
Tx rate      1320 8189 kbps
interleave delay 10 9 ms
CRC block length 204 47 ms
INP symbol time 1.17 6.39 DMT symbol

```

**Configuring the SHDSL Line Port**

Enter to the “**config shdsl**” sub-group directory to configure the relative profile on the SHDSL line port.

```

CLI# config shdsl
CLI(SHDSL)#

```

**Table 5-36 SHDSL Port Interface Configuration**

Use this command to apply the PM alarm profile to specific SDSL line port.	
<b>CLI(SHDSL)# port set alarmprofile</b> <port-range> <profile name>	
Use this command to apply port connection profile to specific SDSL line port.	
<b>CLI(SHDSL)# port set profile</b> <port-range> <profile name>	
Use this command to viewing the SDSL line port operation status.	
<b>CLI(SHDSL)# port show</b> <port-range>	
Parameters	Task
<port-range>	Identify the port range of the system wish to apply the relevance profile of line port. <b>Type:</b> Mandatory <b>Valid values:</b> See “Chapter 2 Port Interface Indication”
<profile name>	Defines the profile name; port connection profile or performance alarm profile. <b>Type:</b> Mandatory <b>Valid values:</b> The name of “port connection profile” or “performance alarm profile”



## Monitoring the SHDSL Connection Status

Enter to the “**status shdsl**” group directory to monitoring the SHDSL line port connection status.

```
CLI# status shdsl
CLI(SHDSL)#
```

**Table 5-37 ADSL Connection Status Monitor**

Use this command to viewing the ADSL line port connection status.	
<b>CLI(status-shdsl)# show</b> <port-range>	
Parameters	Task
<port-range>	Identify the port range of the system wish to view the status of line port. <b>Type:</b> Mandatory <b>Valid values:</b> See “Chapter 2 Port Interface Indication”

## Subscriber Interface Administrating

Enter to the “**config port**” sub-group directory to administrating the ADSL line port.  
 Enter to the “**config shdsl**” sub-group directory to administrating the SHDSL line port.

```
CLI# config port
CLI(PORT)#
```

```
CLI# config shdsl
CLI(SHDSL)#
```

**Table 5-38 ADSL Services Administration**

Use this command to activate the subscriber service of ADSL line port.	
<b>CLI(config port)# enable</b> <port-range>	
Use this command to deactivate the subscriber service of ADSL line port.	
<b>CLI(config port)# disable</b> <port-range>	
Use this command to activate the subscriber service of SHDSL line port.	
<b>CLI(SHDSL)# port enable</b> <port-range>	
Use this command to deactivate the subscriber service of SHDSL line port.	
<b>CLI(SHDSL)# port disable</b> <port-range>	
Parameters	Task
<port-range>	Identify the port range of the system wish to enable or disable the connection of ADSL line port. <b>Type:</b> Mandatory <b>Valid values:</b> See “Chapter 2 Port Interface Indication”

### Example 20Administrating the connection of ADSL line port

```
CLI(config port)# enable 1.1.2
OK

CLI(config port)# disable 1.1.2
OK

CLI(SHDSL)# port enable 1.4.1
OK
```

```
CLI(SHDSL)# port disable 1.4.1  
OK
```

## Chapter 6 Managing the Network Interface

This chapter describes how to configure the Network interface in various network topologies.

This chapter contains the following sections:

- Configuring the Subtending
- Configuring the RSTP
- Configuring the LACP
- Network Interface Administrating

### Configuring the Subtending

The subtending feature provides a mechanism to link a number of NE (IP-DSLAM) into one network trunk port. You can link up the DAS4192, DAS4672 IP-DSLAM chassis through their GE interface.

In a subtended configuration, each chassis is connected by its GE interface to the NC card of the chassis above it, in the subtending hierarchy, or, if it is at the top of the hierarchy, to the network trunk.

The NC card DAS-4672-10 of DAS4672 fixed the GE1 to be Trunk port, and GE2 to be subtend port if subtending function is enable, the parent chassis considers subtended IP-DSLAM management and data traffics to be a transparent network.

#### Subtending Topology

There is one subtending topology that you can create with the DAS-4672-10 NC card, a daisy-chain, where only one chassis is connected to the parent chassis at a time. Figure 6-2 shows a daisy chain subtending topology.

**Figure 6-2** Daisy-Chain Topology for DAS-4672-10 NC Card

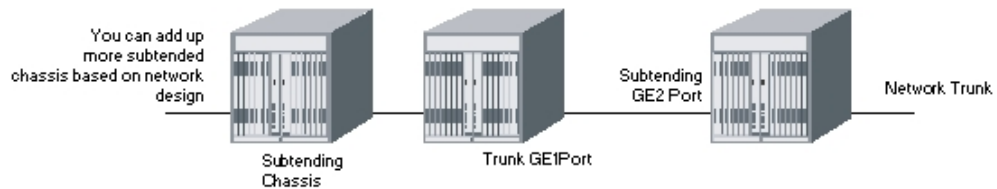

Enter to the “**config**” group directory to manage the subtending function.

```
CLI# config
CLI(config)#
```

**Table 6-39** Subtending Configuration

Use this command to enable, disable, or show the subtend status of system.	
<b>CLI(config)# subtend</b> <option>	
Parameters	Task
<option>	Configure the subtend function of system. <b>Valid values:</b> enable, disable, show



RSTP and LACP can not work with subtending at the same time.

## Configuring the RSTP

The RSTP IEEE 802.1w takes advantage of point-to-point wiring and provides rapid convergence of the spanning tree. Reconfiguration of the spanning tree can occur in less than 1 second (in contrast to 50 seconds with the IEEE 802.1d spanning tree), which is critical for networks carrying delay-sensitive traffic such as voice and video. DAS4672 supports both RSTP and STP protocols in its 2 ports of GE Network interface.

### Port Roles and the RSTP Topology

The RSTP provides rapid convergence of the spanning tree by assigning port roles and by determining the active topology. The RSTP builds upon the IEEE 802.1d STP to select the switch with the highest switch priority (lowest numerical priority value) as the root bridge. DAS4672 IP-DSLAM with RSTP/STP assigns one of their Network interface roles to individual ports as below:

- Root port – Provides the best path (lowest cost) when the switch forwards packets to the root switch.
- Designated port – Connects to the designated switch, which incurs the lowest path cost when forwarding packets from that LAN to the root switch. The port through which the designated switch is attached to the LAN is called the designated port.
- Alternate port – An alternate port is a port blocked by receiving more BPDUs from another bridge.
- Backup port – A backup port is a port blocked by receiving more useful BPDUs from the same bridge it is on.

**Figure 6-3 Spanning Tree Active Topology**

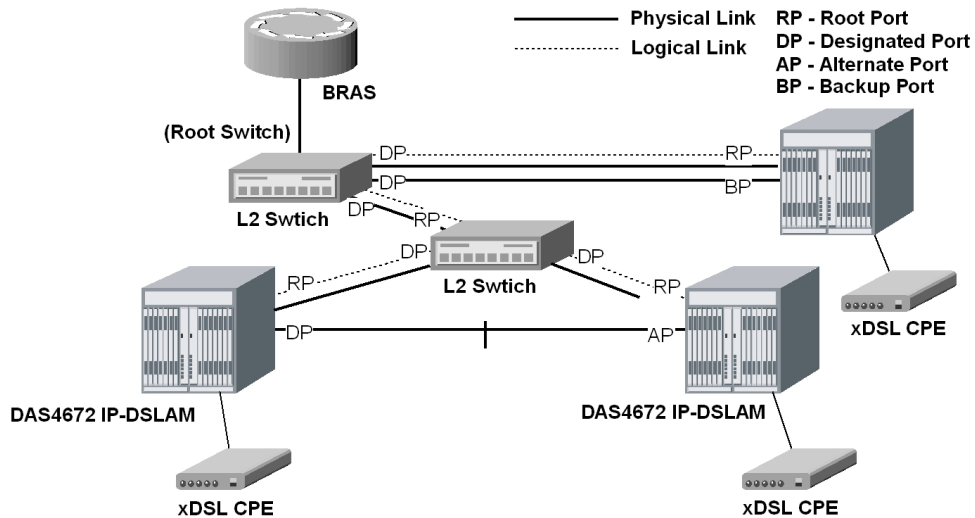

Enter to the “**rstp**” sub-group directory to manage the RSTP function.

```
CLI# config rstp
CLI(RSTP)#
```

**Table 6-40 RSTP Switch Configuration**

Use this command to enable the RSTP function.	
<b>CLI(RSTP)# enable</b>	
Use this command to disable the RSTP function.	
<b>CLI(RSTP)# disable</b>	
Use this command to specify the version, RSTP or STP compatible.	
<b>CLI(RSTP)# set forceversion &lt;protocol&gt;</b>	
Use this command to configure the forwarding-delay for all RSTP instance.	
<b>CLI(RSTP)# set forwarddelay &lt;delay-sec&gt;</b>	
Use this command to configure the interval between the generations of configuration messages by the root switch by changing the hello time.	
<b>CLI(RSTP)# set hellowtime &lt;hello-sec&gt;</b>	
Use this command to configure the maximum-aging time for all RSTP instance.	
<b>CLI(RSTP)# set maxage &lt;aging-sec&gt;</b>	
Use this command to Configure the switch priority and make it more likely that the switch will be chosen as the root switch.	
<b>CLI(RSTP)# set priority &lt;priority-value&gt;</b>	
Use this command to configure the Tx hold count for all RSTP instance.	
<b>CLI(RSTP)# set txholdcount &lt;count&gt;</b>	
Use this command to viewing the RSTP bridge information.	
<b>CLI(RSTP)# show bridge</b>	
Parameters	Task
<protocol>	This specifies the Network interface to be acting in RSTP mode or STP-Compatible mode. <b>Valid values:</b> rstp, stp <b>Default:</b> rstp
<delay-sec>	The forward delay is the number of seconds a port waits before changing from its spanning-tree learning and listening states to the forwarding state. <b>Default:</b> 15 <b>Valid values:</b> 4 ~ 30 (Second)
<hello-sec>	The hello time is the interval between the generation of configuration messages by the root switch. These messages mean that the switch is alive. <b>Default:</b> 2 <b>Valid values:</b> 1 ~ 10 (Second)
<aging-sec>	The maximum-aging time is the number of seconds a switch waits without receiving spanning-tree configuration messages before attempting a reconfiguration. <b>Default:</b> 20 <b>Valid values:</b> 4 ~ 60 (Second)
<priority-value>	Configure the switch priority for an RSTP instance, the range is 0x0000 to 0xF000 in increments of 0x1000. The lower the number, the more likely the switch will be chosen as the root switch. <b>Default:</b> 0x8000 <b>Valid values:</b> 0x0000 ~ 0xF000. All other values are rejected.
<count>	This specifies the value used by the port Transmit state machine to limit the maximum transmission rate. <b>Default:</b> 3 <b>Valid values:</b> 0 ~ 10

The Table 6-41 lists the RSTP port configuration parameters, those parameters allows you to define the port cost, port character, and administration status.

**Table 6-41 RSTP Port Configuration**

Use this command to configure the path cost of port interface.	
<b>CLI(RSTP)# set uge cost</b> <uge-range> <cost-value>	
Use this command to disable the STP function of UGE port.	
<b>CLI(RSTP)# set uge disable</b> <uge-range>	
Use this command to configure the edge port instance.	
<b>CLI(RSTP)# set uge edge</b> <uge-list> {false   true}	
Use this command to enable the STP function of UGE port.	
<b>CLI(RSTP)# set uge enable</b> <uge-list>	
Use this command to migrate the operation of RSTP and STP swap ability.	
<b>CLI(RSTP)# set uge migration</b> <uge-list> {false   true}	
Use this command to configure the point-to-pint instance.	
<b>CLI(RSTP)# set uge p2p</b> <uge-list> {true   false   auto}	
Use this command to configure the port interface priority.	
<b>CLI(RSTP)# set uge priority</b> <uge-list> <port-priority>	
Use this command to viewing the GE Network interface RSTP information.	
<b>CLI(RSTP)# show uge</b>	
Parameters	Task
<uge-value>	This specifies the Network interface number (UGE port). <b>Valid values:</b> 1 (UGE port 1), 2 (UGE port 2)
<cost-value>	The path cost default values is derived from the media speed of an interface. If a loop occurs, the RSTP uses cost when selecting an interface to put in the forwarding state. You can assign lower cost values to interfaces that you want selected first and higher cost values that you want selected last. <b>Default:</b> 20000 <b>Valid values:</b> 1 ~ 200000000
<b>set uge edge</b> <uge-list> {false   true}	If you configure a port as an edge port on an RSTP, the edge port immediately transitions to the forwarding state. An edge port is the same as a Port Fast-enable port, and you should enable it only on ports that connect to a single end station. <b>Default:</b> false <b>Valid values:</b> false, true
<b>set uge migration</b> <uge-list> {false   true}	This specifies the operation version with STP-Compatible to be able to run under RSTP if all region switches is run in RSTP mode. <b>Default:</b> false <b>Valid values:</b> false, true
<b>set uge p2p</b> <uge-list> {true   false   auto}	If you connect a port to another port through a point-to-point link and the local port becomes a designated port, it negotiates a rapid transition with the other port by using the proposal-agreement handshake to ensure a loop-free topology. <b>Default:</b> auto <b>Valid values:</b> true, false, auto
<port-priority>	If a loop occurs, the RSTP uses the port priority when selecting an interface to put into the forwarding state. You can assign higher priority values (lower numerical values) to interfaces that you want selected first and lower priority values (higher numerical values) that you want selected last. <b>Default:</b> 128 <b>Valid values:</b> 0, 16, 32, 48, 64, 80, 96, 112, 128, 144, 160, 176, 192, 208, 224, and 240. All other values are rejected.

## Configuring the LACP

The LACP is defined in IEEE 802.3ad and enables DAS4672 IP-DSLAM to manage 2 ports GE Network interface that conform to the 802.3ad protocol. By using the LACP, the IP-DSLAM learns the identity of partners capable of supporting LACP and the capabilities of each port. It then groups similarly configured ports into a single logical link (aggregate port).

**LACP Modes**

The GE-Channel LACP mode for Network interface configuration contains both the active and passive LACP modes enable ports to negotiate with partner ports to a GE-Channel based on criteria such as port speed and, for Layer 2 GE-Channel, trunking state and VLAN numbers.

Ports can form a GE-Channel when they are in different LACP modes as long as the modes are compatible.

- A port in the active mode can form a GE-Channel with another port that is in the active or passive mode.
- A port in the passive mode cannot form a GE-Channel with another port that is also in the passive mode because neither port starts LACP negotiation.

**Figure 6-4 Typical GE-Channel Configuration**

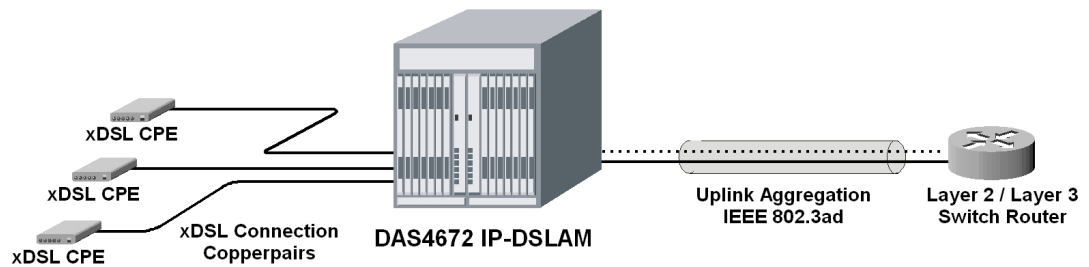

**LACP System Priority**

You can configure the system priority for the GE-Channel that are enable for LACP, by changing this value from the default, you can affect how the software selects active and standby links.

**LACP Port Priority**

By default, all port uses the same port priority. If the local system has a lower value for the system priority and the system ID then the remote system, you can affect which of the standby links become active first by changing the port priority of LACP GE-Channel ports to a lower value than the default. The standby ports that have lower port numbers become active in the channel first.

Enter to the “**la**” sub-group directory to manage the LACP function.

```
CLI# config la
CLI(config la)#
```

**Table 6-42 LACP Configuration**

Use this command to enable the static link aggregation or LACP.
<b>CLI(config la)# enable &lt;option&gt;</b>
Use this command to disable the static link aggregation or LACP.
<b>CLI(config la)# disable</b>
Use this command to configure the LACP group is active or passive.
<b>CLI(config la)# set group-activity &lt;group-id&gt; &lt;activity&gt;</b>
Use this command to define the UGE port which the LACP group is.
<b>CLI(config la)# set group-member &lt;uge-range&gt; &lt;group-id&gt;</b>
Use this command to configure the timeout parameter of the LACP group.
<b>CLI(config la)# set group-timeout &lt;group-id&gt; &lt;timeout&gt;</b>
Use this command to configure the UGE’s priority of LACP.
<b>CLI(config la)# set port-priority &lt;uge-range&gt; &lt;priority&gt;</b>
Use this command to configure the system’s priority of LACP.

Use this command to enable the static link aggregation or LACP.	
<b>CLI(config la)# enable</b> <option>	
Use this command to disable the static link aggregation or LACP.	
<b>CLI(config la)# disable</b>	
Use this command to configure the LACP group is active or passive.	
<b>CLI(config la)# set group-activity</b> <group-id> <activity>	
<b>CLI(config la)# set sys-priority</b> <priority>	
Use this command to viewing the LACP information.	
<b>CLI(config la)# show</b>	
Parameters	Task
<option>	Configure the aggregation mode to LACP or force to static link aggregation. <b>Valid values:</b> lacp   static
<group-id>	This indicates the LACP group ID. <b>Valid values:</b> 0   1
<uge-range>	This indicates the UGE port. <b>Valid values:</b> 1   2
<timeout>	Configure the LACP timeout. Timeout = long means that BPDU send every 30 seconds. Timeout = short means that BPDU send every 1 second. <b>Valid values:</b> long   short
<priority>	This indicates the UGE or system's priority of LACP. <b>Valid values:</b> 0 ~ 65535 or 0x0000 ~ 0xFFFF

## Network Interface Administrating

Enter to the “**config nc**” sub-group directory to administrating the GE network interface.

```
CLI# config nc
CLI(config nc)#
```

**Table 6-43 ADSL Services Administration**

Use this command to activate the subscriber service of specific line port.	
<b>CLI(config nc)# enable</b> <uge-id>	
Use this command to deactivate the subscriber service of specific line port.	
<b>CLI(config nc)# disable</b> <uge-id>	
Use this command to dispaly the UGE inerface status.	
<b>CLI(config nc)# show</b>	
Parameters	Task
<uge-id>	This specifies the Network interface number (UGE port). <b>Valid values:</b> 1 (UGE port 1), 2 (UGE port 2)



## Chapter 7 Managing the Connection Services

This chapter describes how to manage the system connection services.

This chapter contains the following sections:

- Configuring the Bridged Services
- Configuring the Routed Services
- Configuring the Multicast Services
- Monitoring the VC-to-VLAN Connection State
- Configuring the System Services
- Managing the Subscriber Access Services
- Configuring the Access Control List
- Configuring the VLAN MAC Limitation
- Monitoring the VLAN Group
- Monitoring the IGMP Proxy Information
- Monitoring the Subscriber MAC
- Filtering the NetBIOS and NetBEUI

### Configuring the Bridged Services

Enter to the “**config unicast**” sub-group directory to configure the bridged services of unicast connections.

```
CLI# config unicast
CLI(UNICAST)#
```

**Table 7-44 Bridged Services Configuration**

Use this command to create a new VC-to-VLAN connection on specific of xDSL line port.	
<b>CLI(UNICAST)# add vcvlan</b> <port-range> <vpi> <vci>	
Use this command to remove the VC-to-VLAN connection on specific of xDSL line port.	
<b>CLI(UNICAST)# del vcvlan</b> <port-range> <vpi> <vci>	
Use this command to activate the VC-to-VLAN service on specific of xDSL line port.	
<b>CLI(UNICAST)# enable vcvlan</b> <port-range> <vpi> <vci>	
Use this command to deactivate the VC-to-VLAN service on specific of xDSL line port.	
<b>CLI(UNICAST)# disable vcvlan</b> <port-range> <vpi> <vci>	
Use this command to change the bridged VC-to-VLAN parameters on specific of xDSL line port.	
<b>CLI(UNICAST)# set vcvlan</b> <port-range> <vpi> <vci> <802_1p> <iptraffic-profile> <b>bridged</b> <vlan-id> <mac-limit>	
Parameters	Task
<port-range>	Identify the port range of the system wish to configure in bridged services. <b>Type:</b> Mandatory <b>Valid values:</b> See “Chapter 2 Port Interface Indication”

**Table 6-1 Bridged Services Configuration (Continued)**

Parameters	Task
<vpi>	Defines the VPI (Virtual Path Identifier) value. <b>Type:</b> Mandatory <b>Valid values:</b> 0 ~ 255
<vci>	Defines the VCI (Virtual Channel Identifier) value. <b>Type:</b> Mandatory <b>Valid values:</b> 1 ~ 65535 (1 ~ 31 are reserved)
<802_1p>	Defines the tagging of VLAN 802.1p priority of egress switch fabric on specific of VC-to-VLAN connection. <b>Type:</b> Mandatory <b>Default value:</b> 0 <b>Valid values:</b> 0 ~ 7 (low ~ high)
<iptraffic-profile>	Defines the created IP traffic profile name. <b>Type:</b> Mandatory <b>Valid values:</b> The name of “ip traffic profile”
<vlan-id>	Defines the VLAN ID to be assign on specific of VC-to-VLAN connection. <b>Type:</b> Mandatory <b>Default value:</b> 1 <b>Valid values:</b> 1 ~ 4093
<mac-limit>	Defines the limit of MAC address learning from specific bridged service per xDSL line port. Each xDSL line port allow maximum of 8 MAC address learning in total of VC-to-VLAN usage. <b>Type:</b> Mandatory <b>Default value:</b> 1 <b>Valid values:</b> 1 ~ 8

## Configuring the Routed Services

Enter to the “**config unicast**” sub-group directory to configure the routed services of unicast connection. (Next hop up to 4 sets)

```
CLI# config unicast
CLI(UNICAST)#
```

**Table 7-45 Routed Services Configuration**

Use this command to create a new VC-to-VLAN connection on specific of xDSL line port.	
<b>CLI(UNICAST)# add vcvlan</b> <port-range> <vpi> <vci>	
Use this command to create a new ISP (Internet Service Provider) connection.	
<b>CLI(UNICAST)# add nexthop</b> <ispname> <ip-addr> <vlan-id>	
Use this command to remove the VC-to-VLAN connection on specific of xDSL line port.	
<b>CLI(UNICAST)# del vcvlan</b> <port-range> <vpi> <vci>	
Use this command to remove the ISP connection.	
<b>CLI(UNICAST)# del nexthop</b> <ispname>	
Use this command to activate the VC-to-VLAN service on specific of xDSL line port.	
<b>CLI(UNICAST)# enable vcvlan</b> <port-range> <vpi> <vci>	
Use this command to deactivate the VC-to-VLAN service on specific of xDSL line port.	
<b>CLI(UNICAST)# disable vcvlan</b> <port-range> <vpi> <vci>	
Use this command to change the routed VC-to-VLAN parameters on specific of xDSL line port.	
<b>CLI(UNICAST)# set vcvlan</b> <port-range> <vpi> <vci> <802_1p> <iptraffic-profile> <b>routed</b> <ispname>	
Parameters	Task

Use this command to create a new VC-to-VLAN connection on specific of xDSL line port.	
<b>CLI(UNICAST)# add vcvlan</b> <port-range> <vpi> <vci>	
Use this command to create a new ISP (Internet Service Provider) connection.	
<b>CLI(UNICAST)# add nexthop</b> <ispname> <ip-addr> <vlan-id>	
Use this command to remove the VC-to-VLAN connection on specific of xDSL line port.	
<b>CLI(UNICAST)# del vcvlan</b> <port-range> <vpi> <vci>	
<port-range>	Identify the port range of the system wish to configure in routed services. <b>Type:</b> Mandatory <b>Valid values:</b> See “Chapter 2 Port Interface Indication”
<vpi>	Defines the VPI (Virtual Path Identifier) value. <b>Type:</b> Mandatory <b>Valid values:</b> 0 ~ 255
<vci>	Defines the VCI (Virtual Channel Identifier) value. <b>Type:</b> Mandatory <b>Valid values:</b> 1 ~ 65535 (1 ~ 31 are reserved when VPI equal 0)
<ispname>	Defines the ISP name for routed service. <b>Type:</b> Mandatory <b>Valid values:</b> String of up to 32 characters ('0'~'9', 'A'~'Z', 'a'~'z', '!', '!', '!', '@').
<ip-addr>	Defines IP address of the ISP server. <b>Type:</b> Mandatory <b>Valid values:</b> 0.0.0.0 ~ 255.255.255.255
<vlan-id>	Defines the VLAN ID to be assign on specific of VC-to-VLAN connection. <b>Type:</b> Mandatory <b>Default value:</b> 1 <b>Valid values:</b> 1 ~ 4093
<802_1p>	Defines the tagging of VLAN 802.1p priority of egress switch fabric on specific of VC-to-VLAN connection. <b>Type:</b> Mandatory <b>Default value:</b> 0 <b>Valid values:</b> 0 ~ 7 (low ~ high)
<iptraffic-profile>	Defines the created IP traffic profile name. <b>Type:</b> Mandatory <b>Valid values:</b> The name of “ip traffic profile”

## Configuring the Multicast Services

Enter to the “**config mcau**” sub-group directory to configure the multicast connection.

```
CLI# config mcau
CLI(config mcau)#
```

**Table 7-46 Multicast Services Configuration**

Use this command to remove the multicast service on specific of xDSL line port.	
<b>CLI(config mcau)# del</b> <port-range>	
Use this command to activate the multicast service on specific of xDSL line port.	
<b>CLI(config mcau)# enable</b> <port-range>	
Use this command to deactivate the multicast service on specific of xDSL line port.	
<b>CLI(config mcau)# disable</b> <port-range>	
Use this command to change the multicast service with desired parameters on specific of xDSL line port.	
<b>CLI(config mcau)# set</b> <port-range> <vpi> <vci> <vlan-id> <channel-limit> <m-service-name>	
Use this command to show the multicast service with desired parameters on specific of xDSL line port.	

Use this command to remove the multicast service on specific of xDSL line port.	
<b>CLI(config mcau)# del</b> <port-range>	
Use this command to activate the multicast service on specific of xDSL line port.	
<b>CLI(config mcau)# show</b>	
Parameters	Task
<port-range>	Identify the port range of the system wish to configure in multicast services. <b>Type:</b> Mandatory <b>Valid values:</b> See “Chapter 2 Port Interface Indication”
<vpi>	Defines the VPI (Virtual Path Identifier) value. <b>Type:</b> Mandatory <b>Default value:</b> 8 <b>Valid values:</b> 0 ~ 255
<vci>	Defines the VCI (Virtual Channel Identifier) value. <b>Type:</b> Mandatory <b>Default value:</b> 35 <b>Valid values:</b> 1 ~ 65535 (1 ~ 31 are reserved)
<channel-limit>	Defines the limit of concurrent multicast channel transmission on specific of VC-to-VLAN connection. <b>Type:</b> Mandatory <b>Default value:</b> 1 <b>Valid values:</b> 1 ~ 5
<vlan-id>	Defines the VLAN ID to be assign on specific of VC-to-VLAN multicast connection <b>Type:</b> Mandatory <b>Default value:</b> 1 <b>Valid values:</b> 1 ~ 4093
<m-service-name>	This specifies the multicast service profile name <b>Type:</b> Mandatory <b>Valid values:</b> String of up to 32 characters ('0'~'9', 'A'~'Z', 'a'~'z', '-', '_', '!', '@').

## Monitoring the VC-to-VLAN Connection Status

The VC-toVLAN information contains two parts, unicast connection and multicast connection.

### Unicast Connection Status

Enter to the “**config unicast**” sub-group directory to monitoring the unicast connection status.

```
CLI# config unicast
CLI(UNICAST)#
```

**Table 7-47 Unicast Connection Status Monitor**

Use this command to viewing the VC-to-VLAN connection of specific xDSL line port.	
<b>CLI(UNICAST)# show vcvlan</b> <port-range>	
Use this command to viewing the status of ISP server use for routed services.	
<b>CLI(UNICAST)# show nexthop</b>	
Use this command to viewing the launched service type of specific xDSL line port.	
<b>CLI(UNICAST)# show servicetype</b> <port-range>	
Parameters	Task
<port-range>	Identify the port range of the system wish to view the VC-to-VLAN connection. <b>Type:</b> Mandatory <b>Valid values:</b> See “Chapter 2 Port Interface Indication”

### Example 21 Display the unicast connection status

```

CLI(UNICAST)# show vcvlan 1.1.1-1.1.2
Port 1. 1
# VPI VCI IP-traffic prof VLAN 1p MAC RFC2684 next-hop admin oper
-----
1 0 32 test 100 0 1 bridged enabled up

Port 1. 2
# VPI VCI IP-traffic prof VLAN 1p MAC RFC2684 next-hop admin oper
-----
1 0 32 test 100 0 1 routed xinet enabled up

CLI(UNICAST)# show nexthop

ISP-NAME ISP-IP Dst-MAC Vlan-id Status
-----
xinet 10.12.1.252 00:90:96:7c:31:0a 100 V
    
```

### Multicast Connection Status

Enter to the “**config mcau**” sub-group directory to monitoring the multicast connection status.

```

CLI# config mcau
CLI(config mcau)#
    
```

**Table 7-48 Multicast Connection Status Monitor**

Use this command to viewing the multicast connection status of specific xDSL line port.	
CLI(config mcau)# show <port-range>	
Parameters	Task
<port-range>	Identify the port range of the system wish to view the multicast connection. <b>Type:</b> Mandatory <b>Valid values:</b> See “Chapter 2 Port Interface Indication”

#### Example 22 Display the multicast connection status

```

port-id status VPI/VCI VLAN limit service-profile
-----
1. 1. 1 enabled 8/ 35 300 3 program-2
    
```

## Configuring the System Services

The service connection contains parameter to define on each service types.

### Bridged Services Setting

Enter to the “**config bridge**” sub-group directory to configure the system bridging and monitor its status.

```

CLI# config bridge
CLI(config bridge)#
    
```

**Table 7-49 Bridged Services Setting**

Use this command to configure the bridging service aging time.	
<b>CLI(config bridge)# set aging-time &lt;sec&gt;</b>	
Use this command to viewing the bridging aging time status.	
<b>CLI(config bridge)# show</b>	
Parameters	Task
<sec>	Defines the bridging aging time in second. <b>Type:</b> Mandatory <b>Valid values:</b> 10 ~ 1000 (sec.) <b>Default value:</b> 300 (sec.)

**Example 23 Display the bridging status**

```

CLI(config bridge)# show
MAC aging time: 5 min 0 sec (300 sec)

```

**DHCP Broadcast Control**

Enter to the “**config dhcp**” sub-group directory to configure the DHCP broadcast control.

```

CLI# config bridge
CLI(config dhcp)#

```

**Table 7-50 DHCP Broadcast Control**

Use this command to define the action when DHCP packet over rate limit.	
<b>CLI(config dhcp)# set bc &lt;rate-limit&gt; &lt;action&gt;</b>	
Use this command to disable the DHCP broadcast control	
<b>CLI(config dhcp)# disable bc</b>	
Use this command to enable the DHCP broadcast control	
<b>CLI(config dhcp)# enable bc</b>	
Use this command to display the DHCP broadcast control information	
<b>CLI(config dhcp)# show</b>	
Parameters	Task
<action>	Defines the DHCP broadcast packets overflow action. <b>Type:</b> Mandatory <b>Valid values:</b> none, drop, alarm, both <b>Default value:</b> none
<rate-limit>	Defines the DHCP broadcast packets per second <b>Type:</b> Mandatory <b>Valid values:</b> 1 ~ 100000 (pkts/sec.) <b>Default value:</b> 100 (pkts/sec.)

**Example 24 Configure the DHCP broadcast control**

```

CLI(config dhcp)# enable bc
OK

CLI(config dhcp)# set bc 1000 both
OK

CLI(config dhcp)# show

```

```
DHCP option82      : disabled
broadcast control  : enabled
  rate limit       : 1000 pkts/sec
  action over rate limit : both (drop & alarm)
stateful level     : none - show nothing
DHCP relay        : disabled
relay server      : no server exists
```

### DHCP Relay Setting

Enter to the “**config dhcp**” sub-group directory to configure the DHCP relay.

```
CLI# config dhcp
CLI(config dhcp)#
```

**Table 7-51 DHCP Relay Setting**

Use this command to define the DHCP relay server and its correspondent VLAN ID.	
<b>CLI(config dhcp)# add relay-server</b> <server-ip>	
Use this command to remove the DHCP relay server IP	
<b>CLI(config dhcp)# del relay-server</b> <server-ip>	
Use this command to enable the DHCP relay functionality.	
<b>CLI(config dhcp)# enable relay</b>	
Use this command to disable the DHCP relay functionality.	
<b>CLI(config dhcp)# disable relay</b>	
Use this command to configure the stateful mode of DHCP packets.	
<b>CLI(config dhcp)# set stateful</b> <level>	
Use this command to viewing the DHCP relay status.	
<b>CLI(config dhcp)# show</b>	
Parameters	Task
<server-ip>	This specifies the IP address of DHCP server. <b>Type:</b> Mandatory <b>Valid values:</b> Any valid class A/B/C address <b>Default value:</b> None
<level >	Define the print out mode when system receives DHCP packets. <b>Type:</b> Mandatory <b>Valid values:</b> none   flow   pf   all None – show nothing Flow – show flow state only Pf – show packet content and flow state All – all content with hexadecimal data

### DHCP Relay Option 82 Setting

Enter to the “**config dhcp**” sub-group directory to configure the DHCP relay option 82.

```
CLI# config dhcp
CLI(config dhcp)#
```

**Table 7-52 DHCP Relay Option 82 Setting**

Use this command to enable the DHCP relay option 82 functionality.
<b>CLI(config dhcp)# enable op82</b>
Use this command to disable the DHCP relay option 82 functionality.
<b>CLI(config dhcp)# disable op82</b>

**IGMP Snooping/Proxy Setting**

Enter to the “**config igmp**” sub-group directory to configure the IGMP snooping or proxy.

CLI# **config igmp**

CLI(config igmp)#

**Table 7-53 IGMP Snooping/Proxy Setting**

Use this command to activate the IGMP snooping function for multicast services.	
<b>CLI(config igmp)# enable snooping</b>	
Use this command to activate the IGMP proxy function for multicast services.	
<b>CLI(config igmp)# enable proxy</b>	
Use this command to deactivate both the IGMP snooping and proxy function for multicast services.	
<b>CLI(config igmp)# disable</b>	
Use this command to configure the ageing time of IGMP Snooping.	
<b>CLI(config igmp)# set snooping ageing-time &lt;time&gt;</b>	
Use this command to viewing the IGMP status.	
<b>CLI(config igmp)# show</b>	
Use this command to enable the IGMP proxy processes the leave message from subscriber link.	
<b>CLI(config igmp)# set proxy immediated-leave {disabled   enabled}</b>	
Use this command to configure the IGMP proxy response time against the subscriber link.	
<b>CLI(config igmp)# set proxy response-time &lt;sec&gt;</b>	
Use this command to configure the IGMP proxy retry counter.	
<b>CLI(config igmp)# set proxy retries &lt;count&gt;</b>	
Use this command to configure the stateful mode of IGMP packets.	
<b>CLI(config igmp)# set proxy stateful &lt;level&gt;</b>	
Parameters	Task
<time>	Defines the IGMP snooping ageing time in second. <b>Type:</b> Mandatory <b>Valid values:</b> 30 ~ 3600 (sec.) <b>Default value:</b> 300 (sec.)
<sec>	Defines the time period waiting for subscriber response the IGMP message. <b>Type:</b> Mandatory <b>Valid values:</b> 1 ~ 30 (sec.) <b>Default value:</b> 30 (sec.)
<count>	Defines the retry counting for STB response the IGMP message, if the system did not receive IGMP message from subscriber edge, system will treat as 'leave' hence will stop the multicast stream to the particular link. <b>Type:</b> Mandatory <b>Valid values:</b> 1 ~ 5 <b>Default value:</b> 3 (count.)
<level>	Define the print out mode when system receives IGMP packets. <b>Type:</b> Mandatory <b>Valid values:</b> none   flow   msg



Use this command to activate the IGMP snooping function for multicast services.

**CLI(config igmp)# enable snooping**

	None – show nothing Flow – show flow state only Msg – show packet flag and error message
--	--

**Example 25 Display the IGMP snooping/proxy status**

```

CLI(config igmp)# show
IGMP proxy
  status          : enabled
  immediated leave : disabled
  retries         : 3 (times)
  response interval : 30 (seconds)
  stateful level   : "none: show nothing"

IGMP snooping
  status          : disabled
  aging time      : 300 (seconds)
    
```

**Configuring the PPPoE Suboption**

Enter to the “**config pppoe**” sub-group directory to configure the PPPoE suboption.

```

CLI# config pppoe
CLI(config pppoe)#
    
```

**Table 7-54 PPPoE Suboption Setting**

Use this command to enable the PPPoE suboption function.	
<b>CLI(config pppoe)# enable suboption</b>	
Use this command to disable the PPPoE suboption function.	
<b>CLI(config pppoe)# disable suboption</b>	
Use this command to configure the stateful mode of PPPoE packets.	
<b>CLI(config pppoe)# set stateful &lt;level&gt;</b>	
Use this command to display the PPPoE suboption and stateful information.	
<b>CLI(config pppoe)# show</b>	
Parameters	Task
<level>	Define the print out mode when system receives PPPoE packets. <b>Type:</b> Mandatory <b>Valid values:</b> none   flow   msg None – show nothing Flow – show flow state only Msg – show flow message

**Example 26 Configure the PPPoE suboption**

```

suboption-status stateful-level
-----
disabled         none
    
```

## Managing the Subscriber Access Services

Enter to the “**config unicast**” sub-group directory to manage the access service control.

```
CLI# config unicast
CLI(UNICAST)#
```

**Table 7-55 Access Services Configuration**

Use this command to define the access service of particular PVC.	
<b>CLI(UNICAST)# set servicetype</b> <port-range> <vpi> <vci> <mode>	
Use this command to define the authentic IP in static IP access mode.	
<b>CLI(UNICAST)# set servicetypestaticip</b> <port-range> <vpi> <vci> <staticipbase> <iplimit>	
Use this command to viewing the access service status in specific Subscriber port interface.	
<b>CLI(UNICAST)# show servicetype</b> <port-range>	
Parameters	Task
<port-range>	Identify the port range of the system line card <b>Type:</b> Mandatory <b>Valid values:</b> See “Chapter 2 Port Interface Indication”
<vpi>	Defines the VPI (Virtual Path Identifier) value. <b>Type:</b> Mandatory <b>Valid values:</b> 0 ~ 255
<vci>	Defines the VCI (Virtual Channel Identifier) value. <b>Type:</b> Mandatory <b>Valid values:</b> 1 ~ 65535 (1 ~ 31 are reserved)
<staticipbase>	This specifies the static IP address. <b>Type:</b> Mandatory <b>Valid values:</b> Any valid class A/B/C address <b>Default value:</b> None
<iplimit>	This specifies the maximum IP counter in PPPoE/DHCP, and continuous IP count for Static IP. <b>Type:</b> Mandatory <b>Valid values:</b> 1 ~ 8
<mode>	This specifies the authentic of access service mode in particular PVC. <b>Type:</b> Mandatory <b>Valid values:</b> pppoe, dhcp, staticip

### Example 27 Configure the static IP access service

```
CLI(UNICAST)# set servicetype 1.1.1 0 35 staticip
Port 1. 1. 1:OK

CLI(UNICAST)# set servicetypestaticip 1.1.1 0 35 168.95.1.1 1
OK

CLI(UNICAST)# show servicetype 1.1.1
Port 1. 1
PVC  sevice-type  static-IP base  IP counter
-----
0/ 32  static IP   168.95.1.1    1
```

## Configuring the Access Control List

The access control list (ACLs) can block a single host’s access from Subscriber Interface to an IP-DSLAM, it provide filtering to a variety of MAC resources.

ACLs are a series of sequentially processed permit or deny statements that can be used to filter source MAC addresses from Subscriber Interface (PVC base), use permit or deny solo statements at each subscriber PVC connection, permit identify the specifics MAC address to be access while deny all others, same algorithm for deny statement, interlace statements are not support, if so, only the last control statement will be read.

The ACLs generally control the user access right from layer two, as well as MAC limiting function (see “Chapter 7 Configuring the Bridged Service or Configuring the Routed Services”).

Enter to the “**config**” sub-group directory to manage the ACL statement.

```
CLI# config acl
CLI(config acl)#
```

**Table 7-56 Access Control List Configuration**

Use this command to generate a new ACLs rule.	
<b>CLI(config acl)# add</b> <port-range> <vpi> <vci> <mac> {permit   deny}	
Use this command to remove a ACLs rule.	
<b>CLI(config acl)# del</b> <port-range> <vpi> <vci> <mac>	
Use this command to viewing the ACLs statement in specific Subscriber port interface.	
<b>CLI(config acl)# show</b> <port-range>	
Parameters	Task
<port-range>	Identify the port range of the system line card <b>Type:</b> Mandatory <b>Valid values:</b> See “Chapter 2 Port Interface Indication”
<vpi>	Defines the VPI (Virtual Path Identifier) value. <b>Type:</b> Mandatory <b>Valid values:</b> 0 ~ 255
<vci>	Defines the VCI (Virtual Channel Identifier) value. <b>Type:</b> Mandatory <b>Valid values:</b> 1 ~ 65535 (1 ~ 31 are reserved)
<mac>	This specifies the MAC address wish to act from subscriber network. <b>Type:</b> Mandatory <b>Valid values:</b> xx:xx:xx:xx:xx:xx (x valid from 0 ~ 9, a ~ f)
{permit   deny}	Defines the ACL action of specific MAC address in the PVC connection. <b>Type:</b> Mandatory <b>Valid values:</b> permit, deny

## Configuring the VLAN MAC Limitation

The VLAN MAC limitation allows you to manual adjust the MAC learning ability of particular VLAN ID in the system.

Enter to the “**config**” sub-group directory to manage the VLAN MAC limitation.

```
CLI# config vlanmaclimit
CLI(VLANMAC)#
```

**Table 7-57 VLAN MAC Limiting Configuration**

Use this command to enable or disable the MAC limiting of specific VLAN ID.	
<b>CLI(VLANMAC)# set &lt;vid&gt; {on   off}</b>	
Use this command to define the MAC number of specific VLAN ID.	
<b>CLI(VLANMAC)# set &lt;vid&gt; &lt;maclimit&gt;</b>	
Use this command to display the status of VLAN MAC limiting.	
<b>CLI(ACL)# show [&lt;vid&gt;]</b>	
Parameters	Task
<vid>	This specifies the VLAN ID of system. <b>Type:</b> Mandatory <b>Valid values:</b> 0 ~ 4093
{on   off}	This enable/disable the VLAN MAC limiting function of specific VLAN ID. <b>Type:</b> Mandatory
<maclimit>	This defines the MAC number of specific VLAN ID to be accept <b>Type:</b> Mandatory <b>Valid values:</b> 5 ~ 50000

## Monitoring the VLAN Group

The monitoring of subscriber VLAN group function allows you to summarize the VLAN group (ID) with associated xDSL line port in DAS4672 IP-DSLAM.

Enter to the “**status vlan**” sub-group directory to display VLAN ID with associated xDSL line port.

```
CLI# status vlan
CLI(VLAN)#
```

**Table 7-58 Viewing Subscriber VLAN Group**

Use this command to viewing the VLAN group (ID) with associated xDSL line port.	
<b>CLI(VLAN)# show &lt;vid&gt;</b>	
Parameters	Task
<vid>	This specifies the VLAN ID of correspond xDSL line port. <b>Type:</b> Mandatory <b>Valid values:</b> 0 ~ 4093

### Example 28 Display the subscriber VLAN group

```
CLI(VLAN)# show 100

VLAN [100] egress ports on each LC

LC 1: 2-48
LC 2: none
LC 3: none
LC 4: none
```

## Monitoring the IGMP Snoopy/Proxy Information

Enter to the “**status igmpproxy**” sub-group directory to display the IGMP snoop and proxy information with associated xDSL line port.

```
CLI# status igmp
CLI(status igmp)#
```

**Table 7-59 Viewing IGMP Proxy Information**

Use this command to viewing the IGMP group (IP) with associated xDSL line port.	
<b>CLI(status igmp)# group show</b> [<group-ip>]	
<b>CLI(status igmp)# member show</b> <port-id>	
Parameters	Task
<group-ip>	Defines class D IP addressing for multicast channel <b>Type:</b> Mandatory <b>Valid values:</b> 224.0.1.0 ~ 239.255.255.255
<port-id>	Identify the port ID of the system line card <b>Type:</b> Mandatory <b>Valid values:</b> See “Chapter 2 Port Interface Indication”

## Monitoring the Subscriber MAC

The FDB (filtering Database) of DAS4672 system stored the MAC addresses learning from the associate ATM VC at bridged mode.

Enter to the “**status fdb**” sub-group directory to view learning MAC addresses from the associate ATM VC.

```
CLI# status fdb
CLI(FDB)#
```

**Table 7-60 VC MAC Learning Table**

Use this command to displays current list of specified xDSL line port learning MAC addresses.	
<b>CLI(FDB)# show port</b> <port-id>	
Parameters	Task
<port-id>	Identify the port id of the system wish to display current list of learning MAC addresses from their remote network. <b>Type:</b> Mandatory <b>Valid values:</b> See “Chapter 2 Port Interface Indication”

### Example 29 Display the learning MAC addresses from the xDSL line port

```
CLI(FDB)# show port 1.1.2
Port 1.1.2:
ID VPI VCI MAC Address Status
-----
0 8 35 00:00:e2:6b:bf:f0 LU
```

## Filtering the NetBIOS and NetBEUI

The system filter allow operator to define the NetBIOS and NetBEUI name service session to be drop or forward between subscriber interface and network interface.

Enter to the “**config filter**” sub-group directory to define the NetBIOS and NetBEUI filtering function.

```
CLI# config filter
CLI(config filter)#
```

**Table 7-61 NetBIOS and NetBEUI Filter**

Use this command to define the action NetBIOS and NetBEUI filtering.	
<b>CLI(config filter)# netbios</b> <netbios-action>	
Use this command to displays current setting of NetBIOS and NetBRUI filtering.	
<b>CLI(config filter)# show</b>	
Parameters	Task
<netbios-action>	Identify the NetBIOS and NetBEUI filtering action. <b>Type:</b> Mandatory <b>Valid values:</b> drop, forward

## Configuring the MAC Spoofed

The DAS4672 support a function to prevent duplicated MAC address from xDSL user, it maybe opportunist or hacker.

When there are two or more duplicated MAC address from user side learned by DAS4672 at the same time, the default action of DAS4672 is **allow the first MAC address and block all the others.**

In order to prevent the illegal user's MAC address has be allowed with default action when it learned by DAS4672 firstly, DAS4672 support "MAC-Spoofed" function that allow operator to configure the rule for duplicated MAC address manually.

Enter to the "**config spoofed**" sub-group directory to define the MAC Spoofed function.

```
CLI# config mac-spoofed
CLI(config mac-spoofed)#
```

**Table 7-62 MAC Spoofed Configuring**

Use this command to deny all the ports have duplicated MAC, operator assumes they are both illegal.	
<b>CLI(config mac-spoofed)# deny all</b> <mac-addr>	
Use this command to permit the legal MAC address when operator confirmed its right.	
<b>CLI(config mac-spoofed)# permit</b> <mac-addr> <port-id>	
Parameters	Task
<mac-addr>	Indicate the target MAC address. <b>Type:</b> Mandatory <b>Valid values:</b> Valid MAC addresses form. (for example: 00:1F:AA:19:78:03)
<port-id>	Identify the specified xDSL subscriber. <b>Type:</b> Mandatory <b>Valid values:</b> <shelf.slot.port>

## Chapter 8 Managing the System Operations

This chapter describes the system functions of DAS4672 IP-DSLAM.

This chapter contains the following sections:

- Card Module Operations
- System Administrating
- Alarm Definition and Relay Setting
- Configuring the CoS Traffic Mapping

### Card Module Operations

You can define the card module (network card or line card) operation state in DAS4672 system.

#### Defining the Line Card Operation Mode

Configure the system line card type at 'lc' sub-group under 'config' group directory, you are allow to plan the expecting card type address in specific slot, there will have an alarm arise if the planned card type and the actual plug-in card type are mismatch.

The DAS4672 support RFC 2684 encapsulation method for ADSL line card, LLC and VCMUX, respectively, you can define the encapsulation method and VLAN tag pass-through per card base, once the VLAN tag pass-through is enable, system will transparent the VLAN traffic from subscriber interface to network interface, this allows subscriber deployed their own VLAN ID to associate in the network without double tag or replace the VLAN ID by system.

The DAS4672 also support "Service Type Control" for ADSL line card, operator can define the service which allow user to pass, they are "DHCP", "PPPoE" and "Static IP".

Enter to the "config lc" sub-group directory to plan the line card slot.

```
CLI# config lc
CLI(config lc)#
```

**Table 8-63 Plan the Line Card Slot**

Use this command to plan the line card type address in specific slot.	
<b>CLI(config lc)# set planned-type</b> <slot-range> <card-type>	
Use this command to define the RFC 2684 encapsulation method for specific line card.	
<b>CLI(config lc)# set rfc2684-encap</b> <slot-range> <encap-type>	
Use this command to define the VLAN Tag Pass-through function for specific line card.	
<b>CLI(config lc)# set vlan-tag-pass</b> <slot-range> <option>	
Use this command to define the Service Type Control function for specific line card.	
<b>CLI(config lc)# set service-type</b> <slot-range> <option>	
Use this command to monitor the line card plug-in and planned status.	
<b>CLI(config lc)# show</b>	
Parameters	Task
<slot-range>	Identify the slot range of the system <b>Type:</b> Mandatory <b>Valid values:</b> See "Chapter 2 Port Interface Indication"

**Table 8-1 Plan the Line Card Slot (Continued)**

Parameters	Task
<card-type>	Identify the planning line card type <b>Type:</b> Mandatory <b>Valid values:</b> none, adsl, shdsl
<encap-type>	Identify the RFC 2684 encapsulation method. <b>Type:</b> Mandatory <b>Valid values:</b> llc, vc-mux
<option>	Identify the VLAN tag pass-through status or Service Type Control, enable or disable. <b>Type:</b> Mandatory <b>Valid values:</b> on   off

**Example 30 Display the line card type status**

```

CLI(config lc)# show
  LC  planned-type  current  rfc2684-encap  vlan-tag-pass  service-type
  --  -
  1   adsl         adsl     LLC            off            on
  2   adsl         adsl     LLC            off            off
  3   adsl         adsl     LLC            off            off
  4   shdsl        shdsl    LLC            off            off

```

**System Administrating**

The system administrating provides command for you to logout the Telnet session or reboots the system device.

**Reset the Line Card and Port**

The reboot command activates the software restart of system device. The configuration change will be lost if you did not committed (store) it. (Duplicate)

Reset the line card and port using the “reset” command at the prompt for CLI#.

**Table 8-64 Line Card and Port Reset Command**

Use this command to reset the specify line card.	
<b>CLI# reset lc &lt;lc-id&gt;</b>	
Use this command to reset the specify NC card.	
<b>CLI# reset nc &lt;nc-id&gt;</b>	
Use this command to reset the specify xDSL port interface.	
<b>CLI# reset port &lt;port-id&gt;</b>	
Use this command to reset (reboot) the system device.	
<b>CLI# reset system</b>	
Parameters	Task
<lc-id>	Identify the slot id of the system <b>Type:</b> Mandatory <b>Valid values:</b> See “Chapter 2 Port Interface Indication”
<nc-id>	Identify the slot id of the network card <b>Type:</b> Mandatory <b>Valid values:</b> 1   2
<port-id>	Identify the port id of the system <b>Type:</b> Mandatory <b>Valid values:</b> See “Chapter 2 Port Interface Indication”



**Example 31** Reset the line card and xDSL port

```

CLI# reset lc 2

Line Card 2: link up!
LC#02: 00:16:E3:A1:77:05
LC#02: 00:16:E3:A1:77:06
LC#02: 00:16:E3:A1:77:07
LC#02: 00:16:E3:A1:77:04
Boot Line Card 02 ..... [OK]

CLI# reset port 1.2.1
OK
    
```

	The pop-up information for reset line card command shows only on Console port access.
---	---

**Reboot the System**

The reboot command activates the software restart of system device. The configuration change will be lost if you did not committed (store) it.

Reboot the system using the “**reboot**” command at the prompt for CLI#.

**Table 8-65 System Reboot Command**

Use this command to reboot the system device.
<b>CLI# reboot</b>

**Session Logout**

Use this command to terminate the Telnet session or quit the console session from CLI Ex mode.

To logout the sessions using the “**logout**” command at the prompt for CLI#.

**Table 8-66 Session Logout Command**

Use this command to logout the session (Telnet or Console).
<b>CLI# logout</b>

If you are using Telnet access for the CLI Ex mode, the command “**logout**” will terminate the current Telnet session, and the CLI Ex will return to the login prompt if using Console access.

**Alarm Definition and Relay Setting**

The DAS4672 IP-DSLAM allows you to manage the system alarm definition, which contains alarm severity level, report mask, and alarm suppressed.

The alarm relay-in contains four ports to connect with housekeeping device, the relay-in port has ability to detect such devices signal and compare to the given setting, if the status is inconsistent, relay-in alarm will generate. (Grammar Check)

## Configuring the Alarm Definition

Enter to the “**config alarm definition**” sub-group directory to manage the alarm definition.

```
CLI# config alarm definition
CLI(config alarm definition)#
```

**Table 8-67 Alarm Definition Configuration**

Use this command to change the default alarm severities	
<b>CLI(config alarm definition)# set</b> <vendorType> <alarmType> {none   critical   major   minor   info} {true   false} <suppressby>	
Use this command to viewing the status of system alarm severities.	
<b>CLI(config alarm definition)# show</b>	
Parameters	Task
<vendorType>	Defines the vendor type of alarm. <b>Type:</b> Mandatory <b>Valid values:</b> noEntity, cpuModule, adslModule, powerModule, fanModule, adslPort, alarmRelayModule, gePort, alarmRelayInPort
<alarmType>	Defines the alarm type in numerical form. <b>Type:</b> Mandatory <b>Valid values:</b> 1 ~ 31
{none   critical   major   minor   info}	Defines the severity level of alarm type. <b>Type:</b> Mandatory <b>Valid values:</b> none, critical, major, minor, info
{true   false}	Defines the filtering status of specific alarm type. <b>Type:</b> Mandatory <b>Valid values:</b> true, false
<suppressby>	Defines the prevent alarms from being reported on another alarm, when an alarm or condition exists but you do not want it to appear instead of another. <b>Type:</b> Mandatory <b>Valid values:</b> Hexadecimal number

### Example 32Display the system alarm definition

```
CLI(config alarm definition)# show
Alarm definition
 vendor-type  type      name      severity filtered supress-by
-----
noEntity    1      EMPTY    none     false    0x0
cpuModule   0      MISSING  major    false    0x0
cpuModule   1      TEMP     major    false    0x0
cpuModule   2      VOL      major    false    0x0
cpuModule   3      MISMATCH major    false    0x0
cpuModule   6      TCA_DHCP_BC warning  false    0x0
adslModule  0      MISSING  major    false    0x0
adslModule  1      TEMP     major    false    0x0
adslModule  2      VOL      major    false    0x0
adslModule  3      MISMATCH major    false    0x0
adslModule  4      NOT_OPERABLE major    false    0x0
adslModule  31     DIS      info     false    0x0
shdslModule 0      MISSING  major    false    0x0
shdslModule 1      TEMP     major    false    0x0
shdslModule 2      VOL      major    false    0x0
shdslModule 3      MISMATCH major    false    0x0
```

```
shdslModule 4 NOT_OPERABLE major false 0x0
shdslModule 31 DIS info false 0x0
powerModule 0 MISSING major false 0x0
powerModule 4 NOT_OPERABLE major false 0x0
```

### Configuring the System Relay-In Alarm

The DAS4672 support housekeep alarm relays for input signals.

Enter to the “**config alarm relayin**” sub-group directory to activate and monitor the alarm relay-in.

```
CLI# config alarm relayin
CLI(config alarm relayin)#
```

**Table 8-68 System Relay-In Alarm Configuration**

Use this command to configure the system relay-in alarm function.	
<b>CLI(config alarm relayin)# set</b> <relayin-index> <name> {open   close   disable}	
Use this command to viewing the relay-in alarm status.	
<b>CLI(config alarm relayinN)# show</b>	
Parameters	Task
<relayin-index>	Identify the port number of relay-in alarm. <b>Type:</b> Mandatory <b>Valid values:</b> 1 ~ 4
<name>	This specifies the name of given relay-in alarm port. <b>Type:</b> Mandatory <b>Valid values:</b> String of up to 10 characters ('0'~'9', 'A'~'Z', 'a'~'z', '-', '_', '!', '@').
{open   close   disable}	Identify one of the parameter of expects normal status of the relay-in alarm port. <b>Type:</b> Mandatory <b>Valid values:</b> open, close, disable

### Example 33 Display the system relay-in alarm port status

```
CLI(config alarm relayin)# show

Relay-in table
relayin
index      name          normal status  current status
-----
1          Not_Defined  disable  disable
2          Not_Defined  disable  disable
3          Not_Defined  disable  disable
4          Not_Defined  disable  disable
```

### Configuring the CoS Traffic Mapping

Enter to the “**config cos-queue**” sub-group directory to configure the CoS traffic mapping.

```
CLI# config cos-queue
CLI(COSQ)#
```

**Table 8-69 CoS Traffic Mapping**

Use this command to configure the CoS queue mapping between 802.1p priority and system queue index.	
<b>CLI(cos-queue)# mapping &lt;802_1p&gt; &lt;queue-index&gt;</b>	
Use this command to viewing the CoS mapping information.	
<b>CLI(cos-queue)# show</b>	
Parameters	Task
<802_1p>	This indicates the 802.1p priority for VLAN traffic. <b>Type:</b> Mandatory <b>Valid values:</b> 0 ~ 7
<queue-index>	The system switch queue index, the higher the number, the higher the forwarding priority. <b>Type:</b> Mandatory <b>Valid values:</b> 1 ~ 8

## Configuring the Differentiated Service

**DiffServ:** RFC 2474/2475 defines the DiffServ field, which replaces the Type of Service (ToS) field in the IPv4 header. It facilitates the network devices behind IP-DSLAM to fulfill the end-to-end QoS.

Enter to the “**config diffserv**” sub-group directory to configure the DiffServ function.

```
CLI# config diffserv
CLI(config diffserv)#
```

**Table 8-70 Configuring the DiffServ**

Use this command to enable diffserv function.	
<b>CLI(config diffserv)# enable</b>	
Use this command to disable diffserv function.	
<b>CLI(config diffserv)# disable</b>	
Use this command to configure the DiffServ action mapping between 802.1p priority and DSCP value.	
<b>CLI(config diffserv)# mapping &lt;802_1p&gt; &lt;dscp&gt;</b>	
Use this command to viewing the diffserv information.	
<b>CLI(config diffserv)# show</b>	
Parameters	Task
<802_1p>	This indicates the 802.1p priority for VLAN traffic. <b>Type:</b> Mandatory <b>Valid values:</b> 0 ~ 7
<dscp>	Defines the DSCP value mapping to 802.1p priority. <b>Type:</b> Mandatory <b>Valid values:</b> BE   AF11   AF12   AF13   AF21   AF22   AF23   AF31   AF32   AF33   AF41   AF42   AF43   EF

**Figure 8-5 DiffServ Field**

**Differentiated Service Code Point (DSCP):** The six bits in front of DiffServ field called DSCP.

The network device classifies packets and marks them with DSCP value, according to these values, other network devices in the core that support DiffServ can make decision for packets behavior and provide the Quality of Service properly.

A network device classify the priorities of traffic with 6 different levels, they are Express Forwarding (EF), Assured Forwarding Class 4 (AF4), Assured Forwarding Class 3 (AF3), Assured Forwarding Class 2 (AF2), Assured Forwarding Class 1 (AF1) and Best Effort (BE). These classifications are filled into the first 3 bits of DSCP. See Table 8-71 to understanding the precedence level.

Then, the network device differentiates three drop probabilities in AF4~AF1 respectively into last 3 bits of DSCP, they are Low Drop Precedence, Medium Drop Precedence and High Drop Precedence.

**Table 8-71** Precedence Level

Precedence Level	Description
7	For link layer and routing protocol keep alive.
6	For using for IP routing protocols.
5	Express Forwarding (EF)
4	Assured Forwarding Class 4 (AF4)
3	Assured Forwarding Class 3 (AF3)
2	Assured Forwarding Class 2 (AF2)
1	Assured Forwarding Class 1 (AF1)
0	Best Effort (BF)

**Expedited Forwarding:** The code point of EF is 101110, the packets marked with EF is to be transmitted with highest priority, lowest drop.

**Assured Forwarding:** There are 4 classes of AF, and 3 drop precedences with each class. It guarantees a certain amount of bandwidth to a AF class if available. According to a given network’s policy, the packets can be selected a behavior based on required throughput, delay, jitter, loss or according to priority of access to network services. Table 8-72 indicates the relationship of the 4 AF class.

**Table 8-72** DSCP Class Relationship

Drop	Class			
	AF1	AF2	AF3	AF4
Low Drop Prec	001010 (AF11)	010010 (AF21)	011010 (AF31)	100010 (AF41)
Medium Drop Prec	001100 (AF12)	010100 (AF22)	011100 (AF32)	100100 (AF42)
High Drop Prec	001110 (AF13)	010110 (AF23)	011110 (AF33)	100110 (AF43)

This page is leave in blank for note or memo use

## Chapter 9 Diagnostic and Performance Monitoring

---

This chapter describes the filtering rule in different network layer.

This chapter contains the following sections:

- Performance Monitoring on System and Network Interface
- Performance Monitoring on Subscriber Interface
- Monitoring System Alarms
- OAM and Loop Diagnostic Test on Subscriber Interface
- Network Ping Test
- Monitoring the System Environment

### Performance Monitoring on System and Network Interface

Enter to the “**status perf**” sub-group directory to display PM on the Network interface.

```
CLI# status perf
CLI(PERF)#
```

**Table 9-73 Performance Monitoring on System and Network Interface**

Use this command to viewing the PM on the Network interface.

**CLI(PERF)# show nc**

#### Example 34 Display the performance monitor on network interface

```
CLI(STA-PERF)# show nc
interface    unicast  broadcast  multicast  discard  error
-----
UGE-01 inPkts    0        0          0          0        0
      outPkts    0        3          0          0        0
UGE-02 inPkts    0        0          0          0        0
      outPkts    0        0          0          0        0
LC-01  inPkts    6218     84         0          0        0
      outPkts    6281     1          0          0        0
LC-02  inPkts    9448     88         0          0        0
      outPkts    9522     1          0          0        0
LC-03  inPkts    5912     80         0          0        0
      outPkts    5976     1          0          0        0

LC-04  inPkts    79       83         0          0        0
      outPkts    78       78         0          0        0

interface    pause/RX  pause/TX
-----
UGE-01 pkts    0         0
UGE-02 pkts    0         0
```

## Performance Monitoring on ADSL Subscriber Interface

Enter to the “**status perf**” sub-group directory to display PM on the ADSL Subscriber interface.

CLI# **status perf**

CLI(PERF)#

**Table 9-74 Performance Monitoring on ADSL Subscriber Interface**

Use this command to viewing the PM on specific ADSL line port.	
CLI(PERF)# show port <port-id> [near  far]	
Parameters	Task
<port-id>	Identify the port id of the system wish to display the PM with associated time period. <b>Type:</b> Mandatory <b>Valid values:</b> See “Chapter 2 Port Interface Indication”
[near  far]	Identify the PM display on Near-End or Far-End, show both if not specify. <b>Type:</b> Optional <b>Valid values:</b> near, far

### Example 35 Display the performance monitor on subscriber interface

CLI(STA-PERF)# show port 1.1.2

[UserCells/1.1.2]

	Curr15Min	Prev15Min	Curr1Day	Prev1Day
	-----	-----	-----	-----
rxCells	0	0	0	3
txCells	0	0	0	0

[Perf/NE/1.1.2]

	Curr15Min	Prev15Min	Curr1Day	Prev1Day
	-----	-----	-----	-----
UAS	0	0	0	8627
LOFs	0	0	0	30
LOSs	0	0	0	0
LPRs	0	0	0	0
INITs	0	0	0	6
FullINITs	0	0	0	6
ES	0	0	0	0
SES	0	0	0	0
CV	0	0	0	0

[Perf/FE/1.1.2]

	Curr15min	Prev15Min	Curr1Day	Prev1Day
	-----	-----	-----	-----
UAS	0	0	0	8577
LOFs	0	0	0	8
LOSs	0	0	0	7
LPRs	0	0	0	8329
ES	0	0	0	144
SES	0	0	0	45
CV	0	0	0	1618



## Performance Monitoring on SHDSL Subscriber Interface

Enter to the “**status shdsl**” sub-group directory to display PM on the SHDSL Subscriber interface.

```
CLI# status shdsl
CLI(SHDSL)#
```

**Table 9-75 Performance Monitoring on SHDSL Subscriber Interface**

Use this command to viewing the PM on specific SHDSL line port.	
<b>CLI(status-shdsl)# perf</b> <current   history>	
Parameters	Task
<current   history>	Identify the current or history PM of SHDSL port interface. <b>Type:</b> Mandatory

## Monitoring System Alarms

This section explains how to monitor alarms with CLI Ex, which includes viewing current and historical alarm data.

The CLI Ex detects and reports system alarms generated by the DAS4672 and the adjacent network. You can use CLI Ex to monitor alarms at a card, port, or network level and view alarm with severities.

Enter to the “**status alarm**” sub-group directory to monitor system alarms.

```
CLI# status alarm
CLI(ALARM)#
```

**Table 9-76 Viewing the System Alarm**

Use this command to determine the current alarm to be report on the CLI Ex in real-time.	
<b>CLI(ALARM)# reportconsole</b> {on   off}	
Use this command to viewing the current alarm data.	
<b>CLI(ALARM)# show current</b>	
Use this command to viewing the historical alarm data.	
<b>CLI(ALARM)# show alarmhistory</b>	
Use this command to viewing the status of current alarm where to be report on the CLI Ex mode.	
<b>CLI(ALARM)# show reportconsole</b>	
Use this command to viewing the status of current alarm where to be report on the CLI Ex mode.	
<b>CLI(ALARM)# show detail</b> <unit>	
Parameters	Task
{on   off}	This defines the current alarm to be report on the CLI Ex in real-time. <b>Type:</b> Mandatory <b>Vaild value:</b> on, off
{unit}	This indicates the unit on IP-DSLAM. <b>Type:</b> Mandatory <b>Vaild value:</b> All the alarm unit on IP-DSLAM

### Example 36Diagnostic the alarm of system

```
CLI(ALARM)# show current
```

unit	online type	planned type	alarm	last change	severity
shelf	shelf	shelf	-	10-10-00 08:01:40	none
LC1	adslModule	adslModule	-	10-10-00 08:02:10	none
LC1/port01	adslPort	adslPort	-	10-10-00 08:02:30	none
LC1/port02	adslPort	adslPort	v	10-10-00 08:02:09	info
LC1/port03	adslPort	adslPort	v	10-10-00 08:02:09	info
LC1/port04	adslPort	adslPort	v	10-10-00 08:02:09	info
LC1/port05	adslPort	adslPort	v	10-10-00 08:02:09	info
LC1/port06	adslPort	adslPort	v	10-10-00 08:02:09	info
LC1/port07	adslPort	adslPort	v	10-10-00 08:02:09	info
LC1/port08	adslPort	adslPort	v	10-10-00 08:02:09	info
LC1/port09	adslPort	adslPort	v	10-10-00 08:02:09	info
LC1/port10	adslPort	adslPort	v	10-10-00 08:02:09	info
LC1/port11	adslPort	adslPort	v	10-10-00 08:02:09	info
LC1/port12	adslPort	adslPort	v	10-10-00 08:02:09	info
LC1/port13	adslPort	adslPort	v	10-10-00 08:02:09	info
LC1/port14	adslPort	adslPort	v	10-10-00 08:02:09	info
LC1/port15	adslPort	adslPort	v	10-10-00 08:02:09	info
LC1/port16	adslPort	adslPort	v	10-10-00 08:02:09	info
LC1/port17	adslPort	adslPort	v	10-10-00 08:02:09	info
LC1/port18	adslPort	adslPort	v	10-10-00 08:02:09	info
LC1/port19	adslPort	adslPort	v	10-10-00 08:02:09	info

CLI(ALARM)# show alarmhistory

#### History Table

idx	phyidx	planned type	online type	alarm type	occurtime
12562	10236	adslPort	adslPort	20	10-10-00 09:18:44
12563	10236	adslPort	adslPort	21	10-10-00 09:18:44
12564	10236	adslPort	adslPort	22	10-10-00 09:18:44
12565	10236	adslPort	adslPort	23	10-10-00 09:18:44
12566	10236	adslPort	adslPort	24	10-10-00 09:18:44
12567	10236	adslPort	adslPort	25	10-10-00 09:18:44
12568	10236	adslPort	adslPort	26	10-10-00 09:18:44
12569	10236	adslPort	adslPort	29	10-10-00 09:18:44
12570	10236	adslPort	adslPort	30	10-10-00 09:18:44
12571	10236	adslPort	adslPort	31	10-10-00 09:18:44
12572	10237	adslPort	adslPort	1	10-10-00 09:18:44
12573	10237	adslPort	adslPort	2	10-10-00 09:18:44
12574	10237	adslPort	adslPort	3	10-10-00 09:18:44
12575	10237	adslPort	adslPort	4	10-10-00 09:18:44
12576	10237	adslPort	adslPort	5	10-10-00 09:18:44
12577	10237	adslPort	adslPort	6	10-10-00 09:18:44
12578	10237	adslPort	adslPort	7	10-10-00 09:18:44
12579	10237	adslPort	adslPort	8	10-10-00 09:18:44
12580	10237	adslPort	adslPort	9	10-10-00 09:18:44
12581	10237	adslPort	adslPort	10	10-10-00 09:18:44

```
CLI(ALARM)# show detail LC1/port20
```

Detail alarm list is:

alarm name	severity	description
DISABLED	info	The port is disabled

## OAM and Loop Diagnostic Test on Subscriber Interface

In order to diagnose and fix problem, DAS4672 IP-DSLAM Subscriber interface provides for diagnosis of ATM OAM F5 at data connection layer and ADSL loop diagnostic at physical layer, respectively.

### OAM F5 VC Diagnostic

To configure the PVC to send Operation, Administration, and Maintenance (OAM) F5 loopback cells to verify connectivity on the VC (Virtual Circuit) situated in the ATM layer of Subscriber interface. The remote end (CPE) must respond by echoing back such cells

Enter to the “**diag**” group directory with “**oam**” command to perform the OAM F5 VC diagnostic.

```
CLI# diag
CLI(DIAG)#
```

**Table 9-77 OAM F5 VC Diagnosis Test**

Use this command to testing the OAM F5 on both End-to-End and Segment-to-Segment.	
<b>CLI(DIAG)# oam set F5 &lt;port-id&gt; &lt;vpi&gt; &lt;vci&gt; both</b>	
Use this command to testing the OAM F5 on End-to-End only.	
<b>CLI(DIAG)# oam set F5 &lt;port-id&gt; &lt;vpi&gt; &lt;vci&gt; end-to-end</b>	
Use this command to testing the OAM F5 on Segment-to-Segment only.	
<b>CLI(DIAG)# oam set F5 &lt;port-id&gt; &lt;vpi&gt; &lt;vci&gt; seg-to-seg</b>	
Parameters	Task
<port-id>	Identify the port id of the system wish to perform the OAM F5, the define VC must existed at defines line port. <b>Type:</b> Mandatory <b>Valid values:</b> See “Chapter 2 Port Interface Indication”
<vpi>	Defines the VPI (Virtual Path Identifier) value. <b>Type:</b> Mandatory <b>Valid values:</b> 0 ~ 255
<vci>	Defines the VCI (Virtual Channel Identifier) value. <b>Type:</b> Mandatory <b>Valid values:</b> 1 ~ 65535 (1 ~ 31 are reserved)

This example shows how to perform the OAM F5 diagnostic, if the OAM cell from the selected VCL replies the echo, the CLI Ex will shows “**alive**”, check both physical layer and ATM layer setting if shows “**OAM timeout**” otherwise.

### Example 37 Diagnostic the OAM F5 in ATM layer of Subscriber interface

```
CLI(DIAG-OAM)# set F5 1.1.2 0 35 both
Port 1.1.2 pvc 0/35: alive.
OK

CLI(DIAG-OAM)# set F5 1.1.1 0 35 both
```

```
Port 1.1.1 pvc 0/35: OAM timeout.
OK
```

## ADSL Loop Diagnostic

The ADSL loop diagnostic determines the cause of problems on ADSL line port; this function performs real-time performance monitoring capabilities that provide measurements on line quality and noise conditions at both ends of the line.

This function available on ADSL2 and ADSL2+ connection only, the ADSL CPE who did not complied with ITU-T standard G.992.3, G.992.4, and G.992.5 may not be able to perform the loop diagnostics.

Enter to the “**diag**” group directory with “**loopdiag**” command to perform the ADSL loop diagnostic.

```
CLI# diag
CLI(DIAG)#
```

**Table 9-78 ADSL Loop Diagnostic Test**

Use this command to start the run-time loop diagnostic to the specific ADSL line port and it corresponding data connection profile.	
<b>CLI(DIAG)# loopdiag start</b> <i>&lt;port-id&gt;</i> <i>&lt;profile-name&gt;</i>	
Use this command to manually terminating the loop diagnostic if such function has been started.	
<b>CLI(DIAG)# loopdiag stop</b>	
Use this command to viewing the result due to loop diagnostic completed.	
<b>CLI(DIAG)# loopdiag show</b>	
Parameters	Task
<i>&lt;port-id&gt;</i>	Identify the port id of the system wish to perform the loop diagnostic, the define line port must operate in run-time status. <b>Type:</b> Mandatory <b>Valid values:</b> See “Chapter 2 Port Interface Indication”
<i>&lt;profile-name&gt;</i>	This specifies the ADSL port connection profile of the specific ADSL line port. <b>Type:</b> Mandatory <b>Valid values:</b> String of up to 32 characters ('0'~'9', 'A'~'Z', 'a'~'z', '!', '!', '!', '!', '@').

### Example 38 Diagnostic the run-time ADSL line port loop performance

```
CLI(DIAG-LOOPD)# start 1.2.1 test
Ok

CLI(DIAG-LOOPD)# show
Loop diag result:
Port 1. 1

Used Profile: "test"
          ATU-C ATU-R
Attainable Rate(Kbps) 26528.0 1284.0
Loop Attenuation(dB) 0.4 0.0
Signal Attenuation(dB) 0.0 0.0
SnrMargin(dB) 6.0 0.0
TxPower(dBm) 15.3 12.3
H(f) logarithmic representation( Hlog(f) )
```

```

DS          Unit: dB
[ 1] -78.0 -39.0 -42.0 -42.0 -45.0 -44.0 -45.0 -48.0
[ 9] -48.0 -48.0 -47.0 -48.0 -48.0 -48.0 -47.0 -48.0
[17] -51.0 -47.0 -48.0 -52.0 -53.0 -41.0 -41.0 -41.0
[25] -40.0 -36.0 -34.0 -31.0 -28.0 -26.0 -24.0 -22.0
[33] -19.0 -17.0 -15.0 -13.0 -12.0 -10.0 -8.0 -7.0
[41] -6.0 -5.0 -5.0 -4.0 -4.0 -3.0 -3.0 -3.0
[49] -3.0 -3.0 -3.0 -2.0 -2.0 -2.0 -2.0 -2.0
[57] -2.0 -2.0 -2.0 -1.0 -1.0 -1.0 -1.0 -1.0
[65] -1.0 -1.0 -1.0 0.0 0.0 0.0 0.0 0.0
[73] 0.0 0.0 0.0 0.0 0.0 0.0 0.0 1.0
[81] 1.0 1.0 1.0 1.0 1.0 1.0 1.0 1.0
[89] 1.0 1.0 1.0 1.0 1.0 1.0 1.0 1.0
    
```

### ADSL Link Monitoring

Enter to the “diag” group directory with “portmon” command to perform the ADSL link monitoring.

```

CLI# diag
CLI(DIAG)#
    
```

**Table 9-79 ADSL Link Monitoring**

Use this command to start running the link monitoring to the specific ADSL line port.	
<b>CLI(DIAG)# portmon start &lt;port-id&gt;</b>	
Use this command to manually terminating the ADSL link monitoring if such function has been started.	
<b>CLI(DIAG)# portmon stop</b>	
Use this command to viewing the result due to ADSL link monitoring completed.	
<b>CLI(DIAG)# portmon show</b>	
Parameters	Task
<port-id>	Identify the port id of the system wish to perform the link monitoring, the define line port must operate in running status. <b>Type:</b> Mandatory <b>Valid values:</b> See “Chapter 2 Port Interface Indication”

### SELT Link Monitoring

Enter to the “diag” group directory with “sel” command to perform the SELT link monitoring.

```

CLI# diag sel
CLI(DIAG-SELT)#
    
```

**Table 9-80 SELT Link Monitoring**

Use this command to start running the SELT link monitoring to the specific ADSL line port.	
<b>CLI(DIAG-SELT)# start &lt;port-id&gt;</b>	
Use this command to viewing the result due to SELT link monitoring completed.	
<b>CLI(DIAG-SELT)# show</b>	
Parameters	Task
<port-id>	Identify the port id of the system wish to perform the link monitoring, the define line port must operate in running status. <b>Type:</b> Mandatory <b>Valid values:</b> See “Chapter 2 Port Interface Indication”

**Example 39 Diagnostic the run-time ADSL line port loop performance**

```
CLI(DIAG-SELT)# start 1.1.2
```

OK: But the result displays by diag self show.

```
CLI(DIAG-SELT)# show
```

Port single end loop test result:

Port 1. 2. 1:

Cable Type: 24 AWG

Loop Length: 30 (ft.)

## Network Ping Test

The “**ping**” command is a very common method for troubleshooting the accessibility of devices. It uses a series of ICMP (Internet Control Message Protocol) Echo messages to determine a target host is active or inactive.

To diagnose the remote hosts using the “ping” command at the prompt for CLI#. (From UGE or MGE)

**Table 9-81 Network Ping Test**

Use this command to send the ICMP Echo message to target host.	
<b>CLI# ping &lt;hostname&gt;</b>	
Parameters	Task
<hostname>	Defines IP address or hostname of the target host to reply ICMP Echo message. <b>Type:</b> Mandatory <b>Valid values:</b> 0.0.0.0 ~ 255.255.255.255   string

**Example 40 Using Ping command to test the remote host status**

```
CLI# ping 10.1.29.236
```

10.1.29.236 PING Statistics: 5 packets transmitted, 5 packets received

## Monitoring the System Environment

Enter to the “**status**” group directory with proper command to perform the system environment monitoring.

```
CLI# status
```

CLI(STATUS)#

**Table 9-82 System Environment Monitoring**

Use this command to display the system ventilation fan speed information.	
<b>CLI(STATUS)# fanspeed show</b>	
Use this command to display the temperature of specific line card.	
<b>CLI(STATUS)# temp show lc &lt;slot-id&gt;</b>	
Use this command to display the temperature of network card.	
<b>CLI(STATUS)# temp show nc</b>	
Use this command to display the voltage of fan module.	
<b>CLI(STATUS)# voltage show fan</b>	
Use this command to display the voltage of specific line card.	
<b>CLI(STATUS)# voltage show lc &lt;slot-id&gt;</b>	
Use this command to display the voltage of network card.	
<b>CLI(STATUS)# voltage show nc</b>	
Parameters	Task
<slot-id>	Identify the slot range of the line card <b>Type:</b> Mandatory <b>Valid values:</b> See “Chapter 2 Port Interface Indication”





## Appendix A Abbreviations and Acronyms

---

The abbreviations and acronyms used in this document.

**Table A-1 Abbreviations and Acronyms Table**

Abbreviations	Full Name
AAL	ATM Adaptation Layer
ADSL	Asymmetric Digital Subscriber line
AIS	Alarm Indication Signal
ATM	Asynchronous Transfer Mode
ATU-C	ADSL Transceiver Unit at the central office end
ATU-R	ADSL Transceiver Unit at the remote end
CBR	Constant Bit Rate
CV	Coding Violation
DSCP	Differentiated Service Code Point
DSLAM	Digital Subscriber line Access Multiplexer
ES	Error Seconds
EOA	Ethernet over ATM
GBIC	Gigabit Interface Converter
GE	Gigabit Ethernet
IP	Internet Protocol
LAN	Local Area Network
LOF	Loss of Frame
LOS	Loss of Signal
LPR	Loss of Power
OAM	Operation, Administration, and Maintenance
PCR	Peak Cell Rate
PSD	Power Spectral Density
PVC	Permanent Virtual Channel
rtVBR	Real time Variable Bit Rate
SCR	Sustainable Cell Rate
SFP	Small Form Pluggable
SNR	Signal-to Noise Ratio
SNMP	Simple Network Management Protocol
UAS	Unavailable Seconds
UBR	Unspecified Bit Rate
VC	Virtual Channel
VCI	Virtual Channel Identify
VCL	Virtual Channel Link
VDSL	Very high-speed Digital Subscriber line
VLAN	Virtual Local Area Network
VP	Virtual Path
VPI	Virtual Path Identifier
VTU-O	VDSL Transmission Unit at the Optical network interface
VTU-R	VDSL Transmission Unit at the remote end
WAN	Wide Area Network
xDSL	ADSL/VDSL

This page is leave in blank for note or memo use

## **Appendix BIndex**

---