



DCS-3220G

802.11g Wireless 2-Way Audio
Internet Camera With Digital Zoom



Manual
Version 1.10

D-Link®

Building Networks for People
(10/04/04)

Contents

Contents of Package	3
Introduction	4
Features and Benefits	4
Connections	6
Hardware Installation	8
Installation Wizard	9
Installation Wizard Screen	14
Enabling UPnP for Windows XP/Me	17
Installing IP surveillance Software	21
Testing the DCS-3220G	25
Security	26
Using and Configuring the DCS-3220G with a NAT Router	27
Using the DCS-3220G with an Internet Browser	33
Record Snapshots to your FTP server	61
Using IP surveillance Software	65
Installing IP surveillance Software	65
Launcher	70
Monitor Program	73
Scheduling	98
Playback Program	106
Schedule Video Recording with Motion Detection	121
Appendix	124
Frequently Asked Questions	124
How to PING Your IP Address	127
Reset and Restore	128
I/O Connector	129
Adjusting the Camera Focus	133
Replacing the Lens	134
Technical Specifications	135
Contacting Technical Support	137
Time Zone Table	138
Warranty	140
Registration	143

Package Contents



- D-Link **DCS-3220G** Internet Camera
- Power Adapter
- CD-ROM with installation software and manual
- Quick Installation Guide
- Camera Stand
- Category 5 Ethernet Cable
- 2 Antennas

If any of the above items are missing, please contact your reseller.

*Note: Using a power supply with a different voltage than the one included with the **DCS-3220G** will cause damage and void the warranty for this product.*

Minimum System Requirements:

- Internet Explorer 6.x Internet Web Browser
- CPU: Pentium 4, 1.7GHz or above
(Pentium 4, 2.8Ghz plus processor with 512Mb memory and a 32MB video card is required for multiple camera viewing and recording in IP Surveillance)
- Memory Size: 128MB
- VGA card resolution: 800 x 600 or above

Introduction

The D-Link SECURICAM Network™ **DCS-3220G** Wireless Internet Camera is a powerful surveillance system that connects wirelessly to your 802.11g network providing high-quality video, 2-way audio surveillance, and 4x digital zoom¹. The **DCS-3220G** features enhanced 802.11g and connects with a maximum signal rate of up to 54 Mbps² (Megabits per second). The **DCS-3220G** differs from a conventional PC Camera because it is a standalone system with a built-in CPU and Web server, providing a low-cost solution capable of solving demanding security and home/office monitoring needs. The Internet Camera can be accessed remotely, and controlled, from any PC or notebook computer over the Internet from anywhere in the world. Simple installation procedures, along with the built-in Web-based interface offers easy integration to your network environments.

Features and Benefits

The SECURICAM Network™ **DCS-3220G** Wireless Internet Camera is a standalone system requiring no additional hardware or software. All that is required is a computer with the Internet Explorer Web browser (version 6.x or above). Just plug in the camera and view the picture from your Internet Camera with a valid IP Address.

CCD Sensor

The **DCS-3220G** comes standard with a high quality CCD sensor that is superior to a CMOS type sensor. The fixed focus glass lens will facilitate the use of the **DCS-3220G** providing crystal clear and sharp images. You can view up to 30 frames³ per second of live motion video with 380 TV lines of resolution.

Broad Range of Applications

With today's high-speed Internet, the Internet Camera provides the ideal solution for live video images and audio over the Intranet and Internet for remote monitoring. The **DCS-3220G** allows remote access from an Internet Explorer Web browser for live image viewing with audio and allows the administrator to manage and control the Internet Camera anywhere and any time. Apply the Internet Camera to monitor various objects and places such as homes, offices, banks, hospitals, child-care centers, amusement parks and other varieties of industrial and public monitoring. The Internet Camera can also be used for intruder detection with its motion-detection mode, capture still images and video images for archiving and many more applications such as sending images to an FTP server or configuring for E-mail alerts.

¹ 4x digital zoom enlarges an image by magnifying the pixels in a selected portion of the image by 4 times.

³ Actual frame rate will vary due to network traffic, compression rate, frame rate, and lighting.

Features & Benefits (continued)

The **DCS-3220G** features 2-way audio with a built-in microphone that lets you remotely monitor and record audio. With the addition of optional speakers (not included), you can have 2-way audio communication with the people you are viewing. The **DCS-3220G** features 4x digital zoom for closer viewing. The wireless capability means you can place the camera where it is inconvenient to install network cables.

Supports a Variety of Protocols

Supporting TCP/IP networking, SMTP e-mail, HTTP and other Internet related protocols, the **DCS-3220G** Internet Camera can be integrated easily into other Internet/Intranet applications because of its standards-based features. The camera also supports UPnP™ and DDNS. DDNS allows the camera to use an easier to remember naming format rather than an IP address. UPnP™ will allow users of Windows XP and Me to install the camera using Plug-and-Play technology.

Web Configuration

Using the Internet Explorer Web browser, administrators can configure and manage the Internet Camera directly from its own Web page via the Intranet or the Internet. Up to 20 user names and passwords are permitted, with privilege settings controlled by the administrator.

Powerful Surveillance and Remote Monitoring Utility

The powerful **IP surveillance** software application assigns an administrator with a pre-defined user ID and password who can modify the Internet Camera settings from a remote site via an Intranet or the Internet. Administrators are allowed to monitor the image, record the image to a hard drive, and take snapshots.

Connection to External Devices

Supporting auxiliary Input/Output connectors, you can connect the Internet Camera to a variety of external devices such as IR-sensors, switches and alarm relays. Combined with programmable alarming facilities, you can develop a variety of security applications that are triggered on alarm-based events. The Internet Camera provides an industry standard in/out external connector for connectivity.

Note: Use of audio or video equipment for recording the image or voice of a person without their knowledge and consent is prohibited in certain states or jurisdictions. Nothing herein represents a warranty or representation that the D-Link product provided herein is suitable for the end-user's intended use under the applicable laws of his or her state. D-Link disclaims any liability whatsoever for any end-user use of the D-Link product, which fails to comply with applicable state, local, or federal laws.

Connections

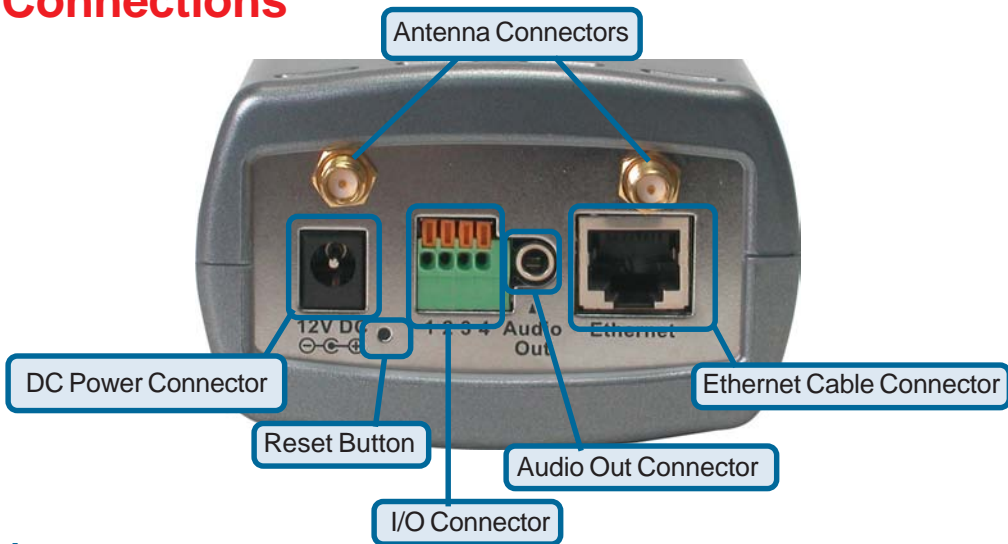

Antenna

Two antennas are included with the **DCS-3220G**. These are screwed onto the antenna connectors on the back panel to provide a connection with a wireless network.

Ethernet Cable Connector

The Internet Camera's back panel features an **RJ-45** connector for connections to 10Base-T Ethernet cabling or 100Base-TX Fast Ethernet cabling. This network port supports the **NWay protocol**, allowing the Internet Camera to automatically detect or negotiate the transmission speed of the network.

The Ethernet cable included with the **DCS-3220G** Internet Camera is a Category 5 “straight through” cable. This is the recommended cable type when the camera is physically connected to a 100 Mbps Fast Ethernet network hub or switch.

Reset Button

Reset will be initiated when the reset button is pressed once and held until the Power LED flashes through its cycle twice.

A reset to factory defaults is initiated when the reset button is pressed continuously for 5 seconds or when the Power LED changes from **green** to **red** for 2 cycles. (For example you will see the LED turn to **red** twice, release the reset button when the LED turns **red** the second time). The Power LED will begin to flash indicating that the Internet Camera's settings are reverting back to the factory settings, then turn back to **green**. To reset the camera press the reset button once and the light will flash **orange**.

Connections (continued)

DC Power Connector

The DC power input connector is located on the **DCS-3220G** Internet Camera's back panel and is labeled **12VDC** with a single socket to supply power to the Internet Camera.

I/O Connector

The **DCS-3220G** provides a terminal block with two pairs of connectors situated on the back panel. One pair is for input and the other is for output. The I/O connectors provide the physical interface to send and receive digital signals to a variety of external alarm devices. **Please refer to the Appendix (page 124) in this manual for detailed information.**

Audio Out Connector

The **DCS-3220G** provides an Audio Out connector to be used for 2-way audio. Speakers (not included) may be connected to the camera to provide audio for 2-way communication with those you are viewing.

Bottom Panel



Attachment socket for the Camera Stand

Located on the bottom panel of the Internet Camera, the socket is used to connect the camera stand to the Internet Camera by attaching the screw head on the camera stand to the Internet Camera.

Power LED

LED stands for **L**ight-**E**mitting **D**iode.

The Power LED is positioned to the right of the Internet Camera lens. As soon as the power adapter is connected to the Internet camera the power LED will flash **red** and **green** several times, the **DCS-3220G** is conducting a self-test. Upon passing the self-test the LED will turn **green** to indicate a good connection to an Ethernet port or **red** to indicate no connection has been made.

Hardware Installation

1 Connect to a Network

If you are connecting the **DCS-3220G** to a **wired** Ethernet network, connect an Ethernet cable to the network cable connector located on the Internet Camera's back panel and attach it to the network.



If you are connecting the **DCS-3220G** to a **802.11g wireless** Ethernet network, attach the two wireless antennas to the antenna connectors on the back panel of the **DCS-3220G**.



2 Attach the external power supply

Attach the external power supply to the DC power input connector located on the Internet Camera's back panel (labeled **12VDC**) and connect it to your wall outlet.



When you have a proper connection, the LED will turn from **red** to **green**. The light may cycle on and off and your computer may show an intermittent loss of connectivity, this is normal until you have configured your Internet Camera.

Attaching the Internet Camera to the Camera Stand

The Internet Camera comes with a camera stand with a swivel ball screw head that can be attached to the Internet Camera bottom socket cavity. Attach the camera stand to the Internet Camera and station it for your application. There are holes located in the base of the camera stand allowing the Internet Camera to be mounted to the ceiling, or any wall securely.



Installation Wizard

After you have successfully completed the hardware installation of the **DCS-3220G** Internet Camera, it is necessary to install software to configure and operate the camera. The first step is to run the **Installation Wizard** program on the CD. **Installation Wizard** allows you to use the Internet Camera with your Internet browser.

After the **Installation Wizard** software program is completed, you will have an operating and controllable Internet Camera. From your Internet Explorer Web browser you will be able to access the video and sound from the Internet camera. The camera has a built-in Web server. This Web server will allow the camera to access the Internet without being attached to a computer and permits users to view the video and audio remotely.

However, it is necessary to install the **IP surveillance** software from the enclosed CD to create a truly powerful monitoring and surveillance system. The following section will detail the installation of the **Installation Wizard** and the **IP surveillance** software.

Installing the Installation Wizard program

Insert the CD that is included with the **DCS-3220G** Internet Camera. The **DCS-3220G** installation menu will start up automatically from the CD. If the CD does not startup automatically (the Windows operating system can turn this function off, for example), go to Start > Run and type D:\autorun (if D:\ is your cd-rom drive) to access the installation menu shown below:



Installation Wizard (continued)

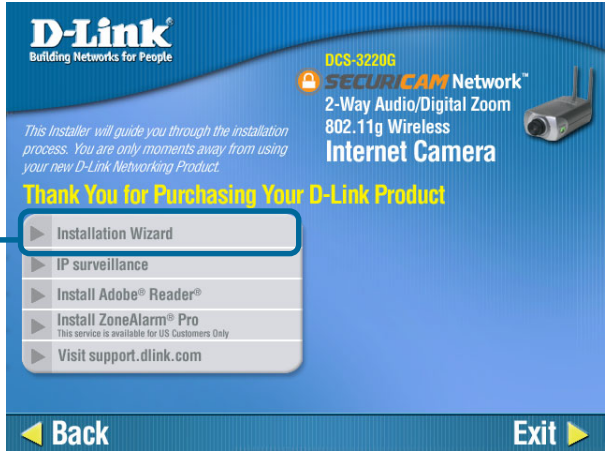

Click **Installation Wizard**

Please wait while the InstallShield Wizard prepares to install.

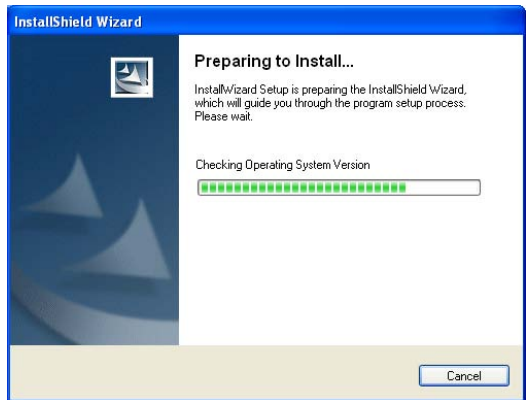

Click **Next**.

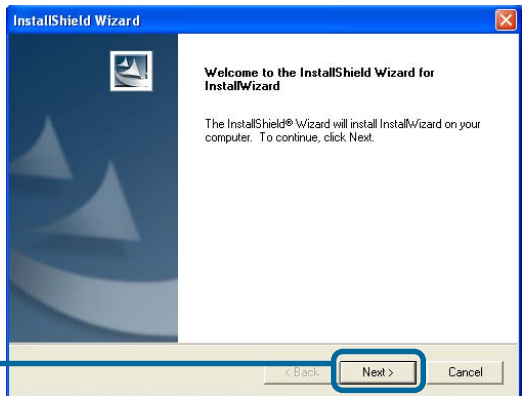

Installation Wizard (continued)

The InstallShield will install in the following folder. To install into a different folder, click Browse and select another folder.

Click **Next**.

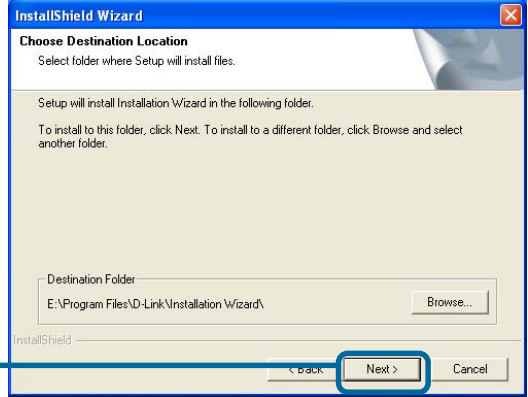

Select the Program folder that Setup will add program icons to. You may type a new folder name, or select one from the existing folders list.

Click **Next**.

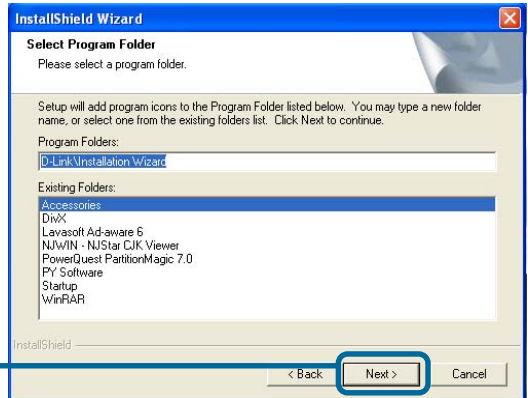

Please wait while the Installation Wizard is installed.

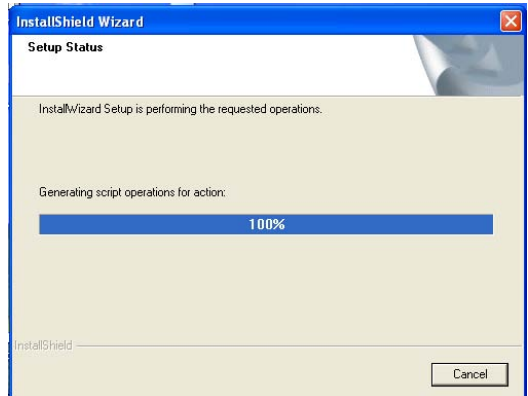

Installation Wizard (continued)

Installation is now complete.

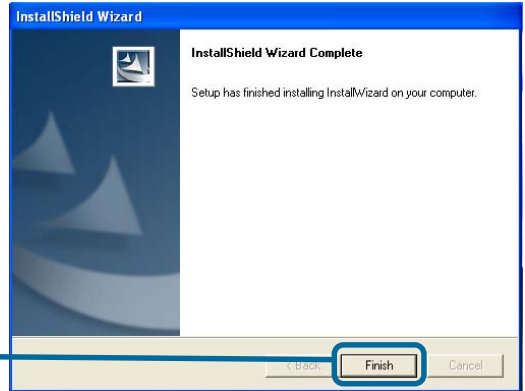

To access the Installation Wizard screen, click on the Installation Wizard Icon on your desktop.

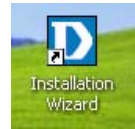

The opening Installation Wizard screen will appear and show a MAC address of the **DCS-3220G** and an IP Address (which may or may not be correct depending on what you have your **DCS-3220G** connected to). If you have a DHCP* server on your network, there will be a valid IP Address displayed here, indicated by a “Yes” under the assigned column.

*A DHCP server is a device that supplies IP Addresses to its clients that are on the same network.

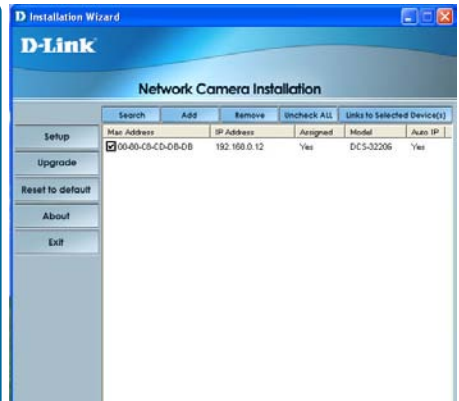

IMPORTANT:

A hardware reset of the Internet Camera may be required if the **Installation Wizard** cannot find the camera. To accomplish this reset, lightly insert a paper clip (or a similar sized tool) into the reset hole on the back of the camera (see page 6 for the location of the reset hole). The LED on the front of the camera will begin blinking orange. When it stops the blinking cycle continue to hold in the reset button until a second cycle of blinking red and green lights indicates a second reset cycle has completed. This will take approximately 5-7 seconds.

Installation Wizard (continued)

The **Installation Wizard** will now show a MAC address for the **DCS-3220G** and an IP address. This IP address may not be correct at this step in the installation until you see “Yes” under the assigned column. The camera is now automatically configured with an IP address consistent to the device it is connected to.

Select the MAC address.

Click on the **Link to Selected Devices** button.

For more information regarding the functions of this screen, see the following section titled “Installation Wizard Screen.”

After you click on the **Link to Selected Devices** button, **Installation Wizard** will automatically open your Internet browser to the IP Address of the **DCS-3220G**, in this example it is: <http://192.168.0.12>. Your **DCS-3220G** may have a different IP Address.

You have now completed the Setup Wizard and are ready to use your camera! You can also continue to the section titled “Installing IP surveillance Software” (page 21) to install the IP surveillance software before you begin to use the DCS-3220G.

Installation Wizard Screen

The following options are available on the Installation Wizard screen by clicking on the corresponding tab:

Search -

Click to search for any available cameras to connect to the network.

Add -

Click to manually add a camera to the network. A window will appear, prompting you to enter the camera's IP address or domain name. A second window will appear, prompting you to enter the port number.

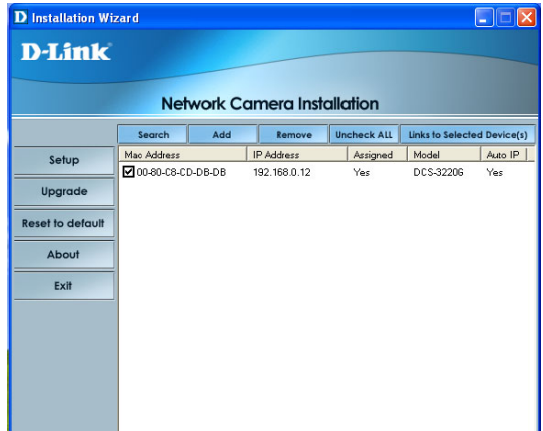

Remove -

Click to remove the selected camera(s) from the network.

Uncheck All -

Click to uncheck all selected cameras.

Links to Selected Devices -

Click to link all selected devices to the network.

Setup -

On the initial Setup Screen you can configure System and Date/Time settings for each camera. Click **Next** to configure Network settings for the camera.

System Settings -

Enter a Camera Name and create a Root password for the camera.

Date/Time Settings -

Enter the Date and Time for each camera. These settings can also be configured on the **Tools > System** screen (page 53) when configuring the camera via a Web browser.

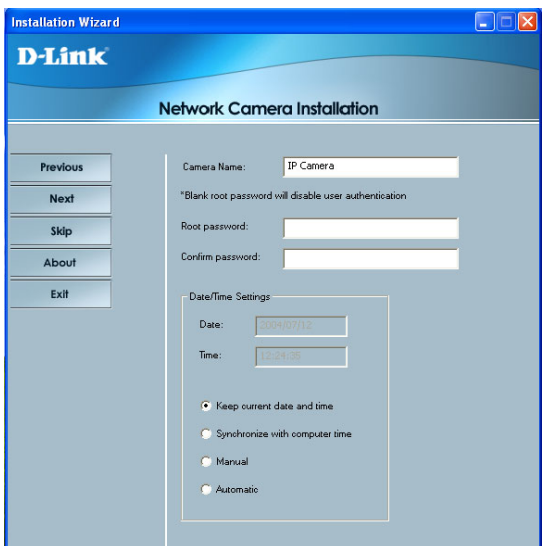

Installation Wizard Screen (continued)

Network Settings -

Here users can configure the Network Settings for the camera. Enter the IP address, Subnet mask, Default router IP, Primary DNS, and Secondary DNS. Automatically, the option to reset IP address at boot is selected. If you would like to save your IP address settings, make sure to uncheck this box.

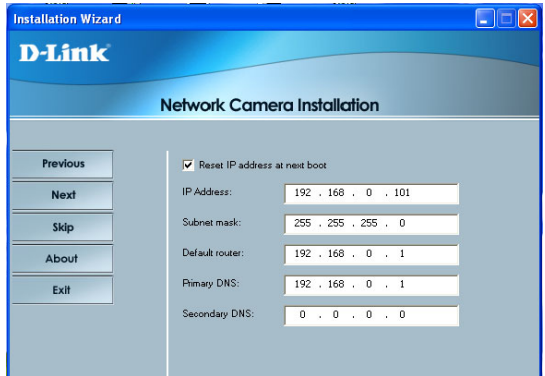

Here users can configure the Wireless Network Settings for the camera. Enter the SSID and select the Wireless mode, Channel, Tx Rate, and Preamble. Check the Data Encryption box to enable data encryption and configure the settings. These settings are explained and can also be configured on the **Advanced > Network screen** (page 37) when configuring the camera via a Web Browser.

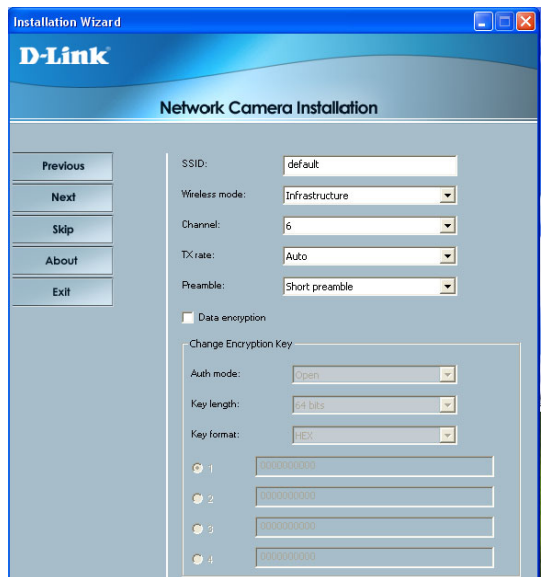

Click Next and then **Apply** to save the configured settings. Users can click **Previous** to modify changes or mistakes.

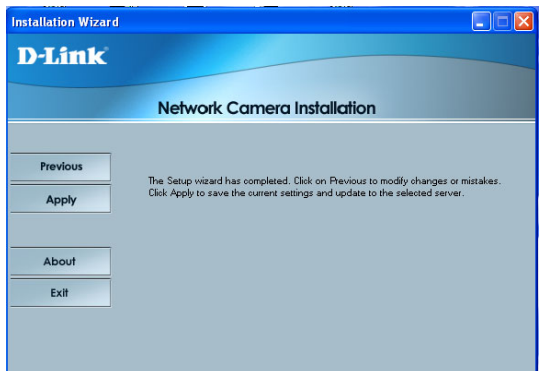

Installation Wizard Screen (continued)

The upgrade window allows users to upload a saved firmware file. If the firmware is older than that currently on the camera, a screen will appear indicating so and prompting the user to confirm the upload.

Package Information -

This displays information about the firmware and plugin currently installed on the camera.

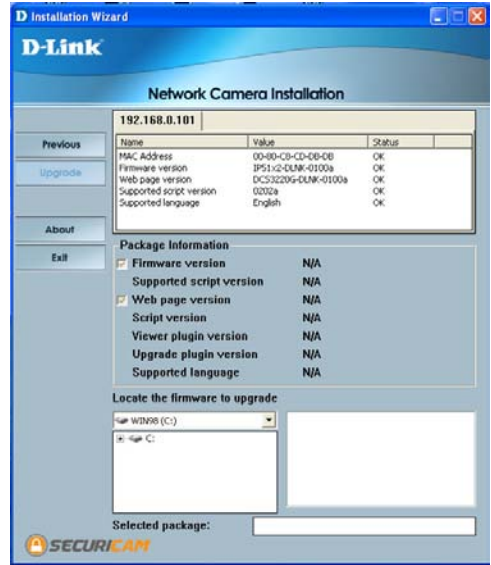

Upgrade -

Locate the Firmware to Upgrade -

Indicate the location of the firmware to be uploaded to the camera.

Selected Package -

This displays the file name of the firmware selected for upload.

Reset to Default -

Click the Reset to Default tab to reset the camera's settings to factory defaults.

About -

Click About to display the current version and date.



Exit -

Click the Exit tab to exit the Installation Wizard screen.

Enabling UPnP for Windows XP/Me

UPnP is short for Universal Plug and Play, which is a networking architecture that provides compatibility among networking equipment, software, and peripherals. The **DCS-3220G** is a UPnP enabled Internet camera. If your operating system is UPnP enabled, the device will be easier to configure. If you do not want to use the UPnP functionality, it can be disabled by unchecking the Enabled DDNS checkbox in the DDNS/UPnP settings page under “Advanced” in the configuration menu. Use the following steps to enable UPnP (Universal Plug and Play) settings only if you are running Windows XP/Me. If you are running Windows 98/2000, UPnP is not available.

- Go to **Start >Settings**.

Click **Control Panel**

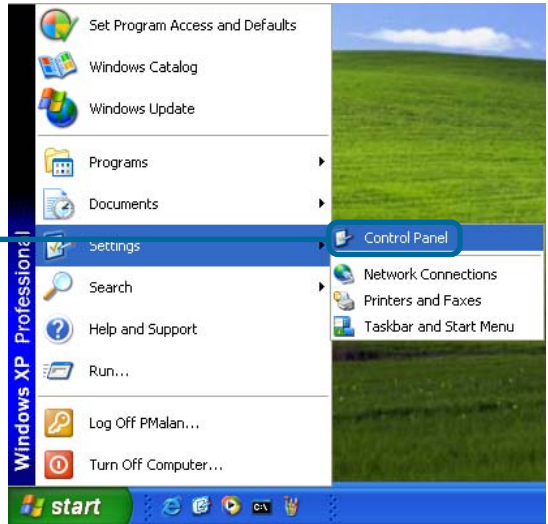

Click **Add or Remove Programs**

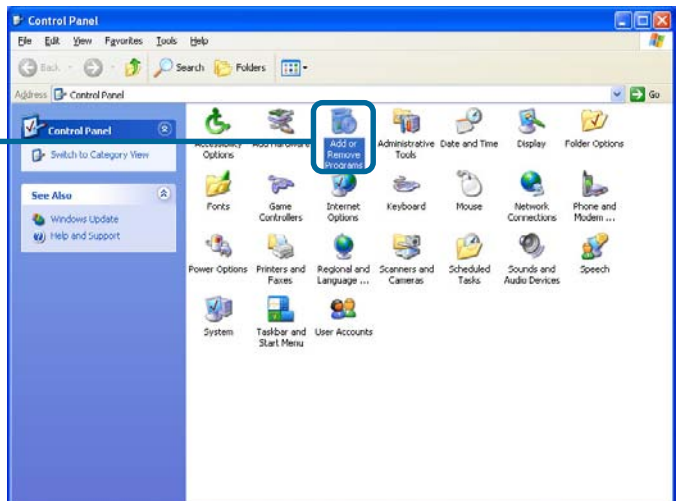

Enabling UPnP for Windows XP/Me (continued)

Click **Add/Remove Windows Components**

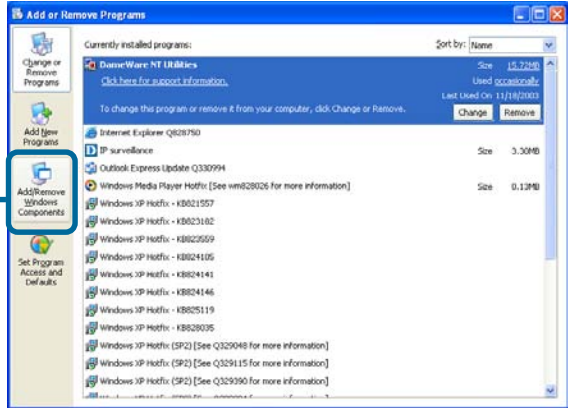

The following screen will appear:

Select **Networking Services** (Communications in Windows Me)

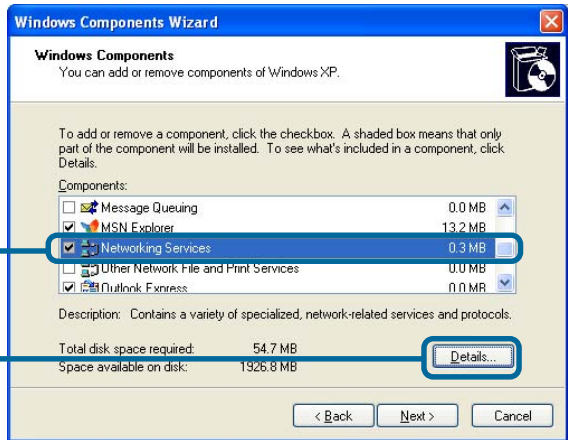

Click **Details**

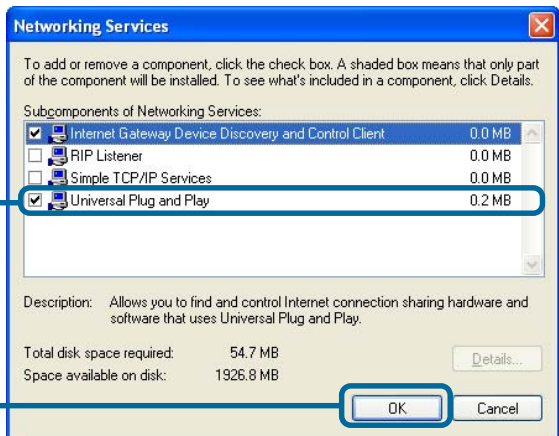

Select **Universal Plug and Play**

Click **OK**

Enabling UPnP for Windows XP/Me (continued)

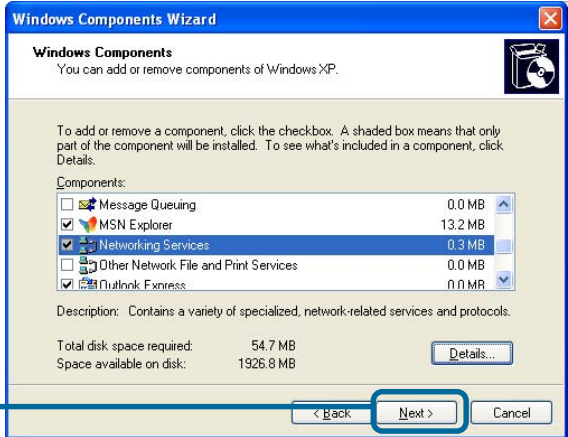

Please wait while Setup configures the components.

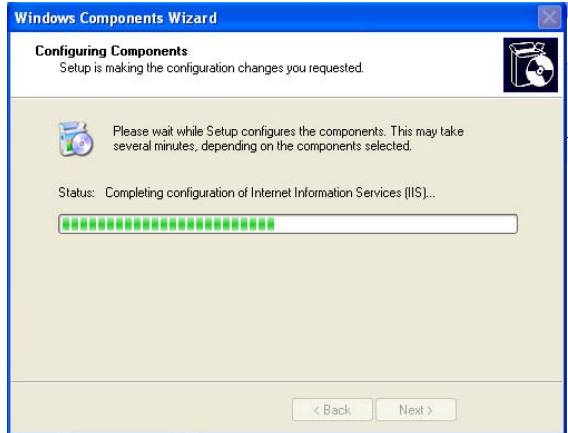

Click Finish



Enabling UPnP for Windows XP/Me (continued)

To view your **DCS-3220G** Internet Camera in an Internet browser, go to your Desktop and click **My Network Places**.

Click **My Network Places**

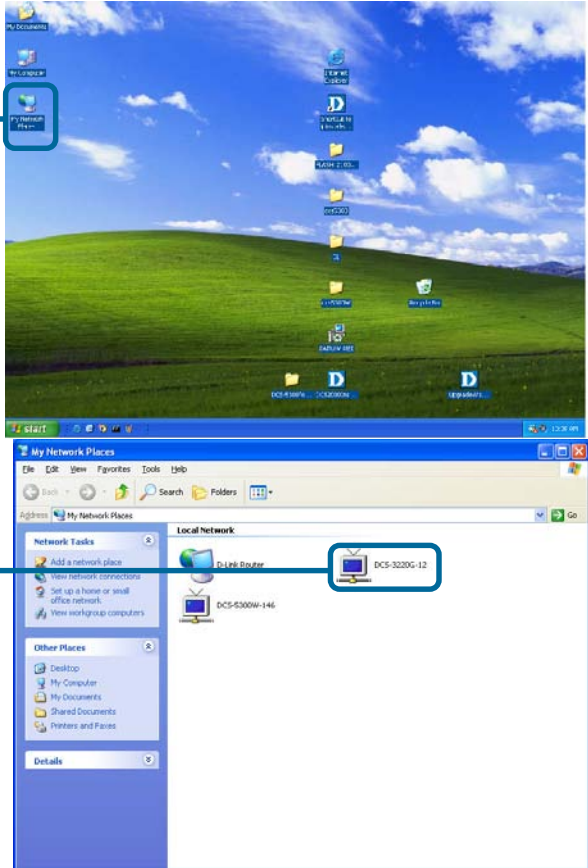

Click **DCS-3220G-12**

The last digit(s) (12), represent the fourth octet of your Internet Camera's IP address (in this example, 198.168.0.12).



After you click on the **DCS-3220G-12** icon, your Internet browser will automatically be opened to the IP Address of the **DCS-3220G**, in this example it is: <http://192.168.0.12>. Your **DCS-3220G** may have a different IP Address.

(Note: Screen shots are taken in Windows XP, similar screens will appear in Windows Me.)

Installing IP surveillance Software

The **IP surveillance** software on the CD included with the **DCS-3220G** Internet Camera converts the **DCS-3220G** into a powerful, yet flexible, surveillance system for home or business, with these features:

- Real-time Monitoring
- Video Recording to hard disk
- High quality video
- High video compression ratio
- Maximum of 16 cameras with different display layouts
- Smart playback
- Triggered event browsing
- Fast database searching
- Configurable automated alarms
- Account password protection
- Scheduled recording for each camera
- Email / FTP video snapshots
- AVI file export
- Motion detection for each camera

To install **IP surveillance**, click on the **Install IP surveillance Software** on the CD included with the Internet Camera. The **Welcome** screen appears:

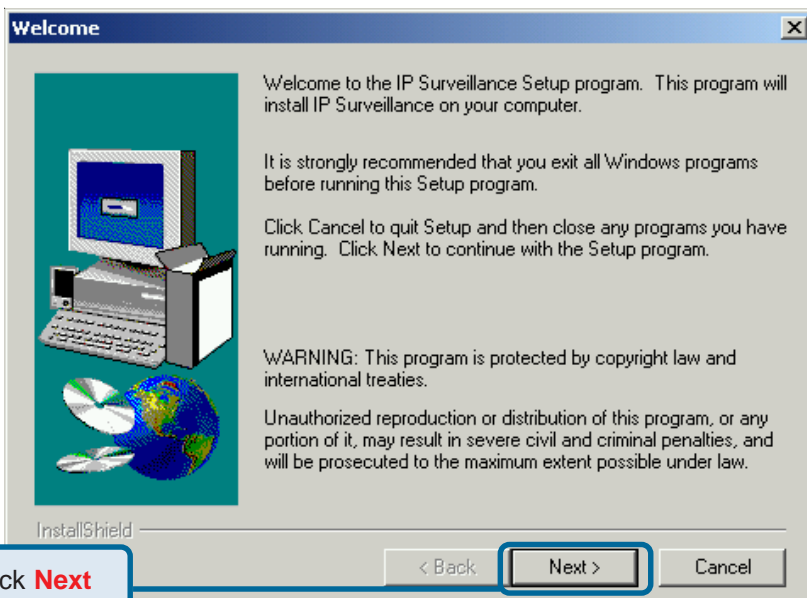

Installing IP surveillance Software (continued)

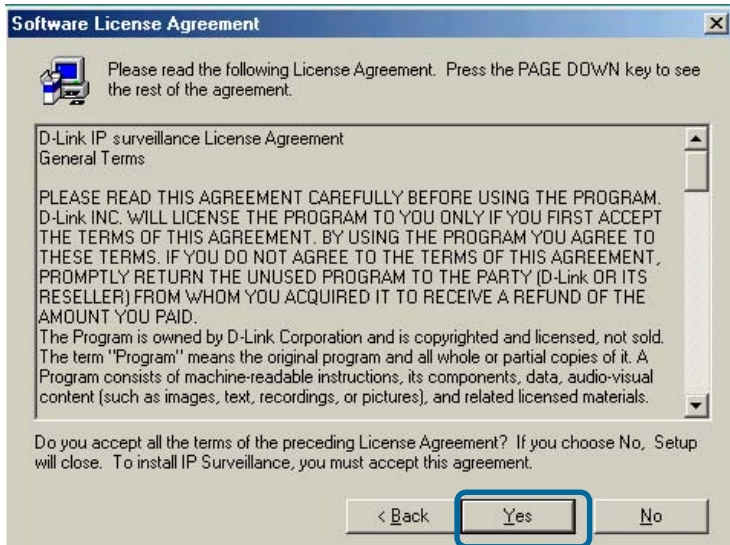

Click **Yes**

Please read the Software Licensing Agreement and click **Yes** if you wish to accept the agreement. Click **No** to exit the installation.

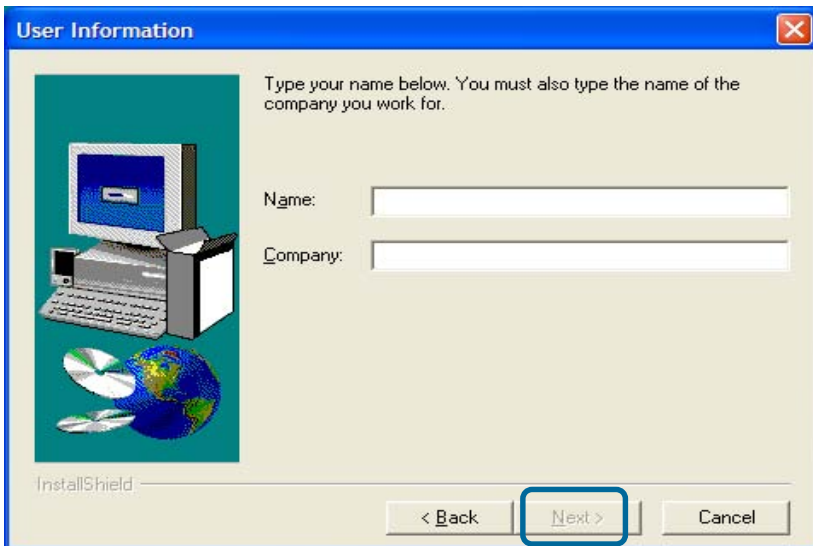

Click **Next**

Enter your name and company information and click **Next**.

Installing IP surveillance Software (continued)

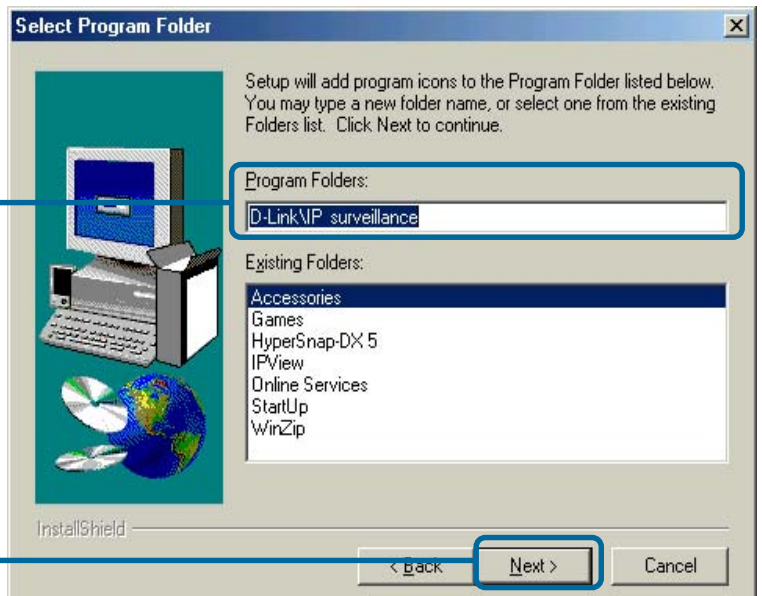
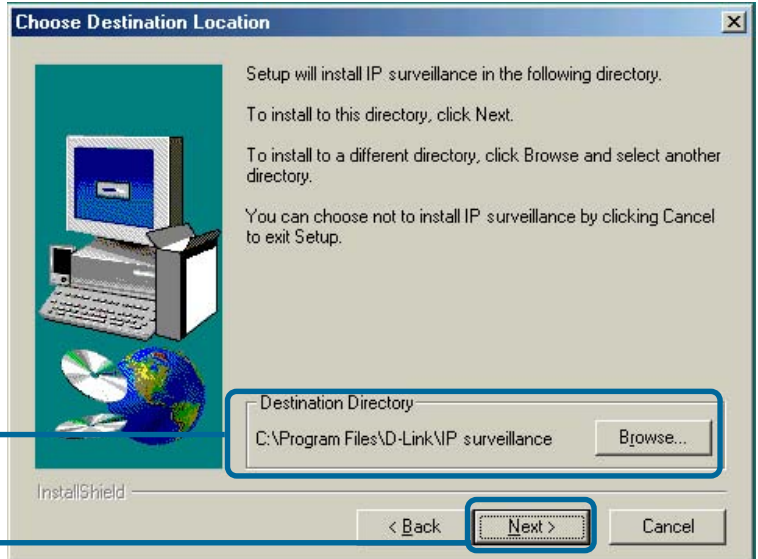

Installing IP surveillance Software (continued)

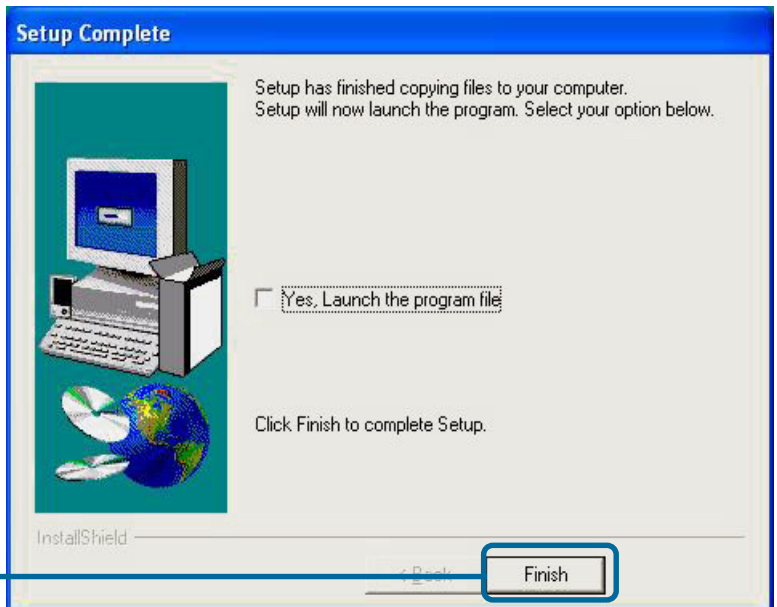
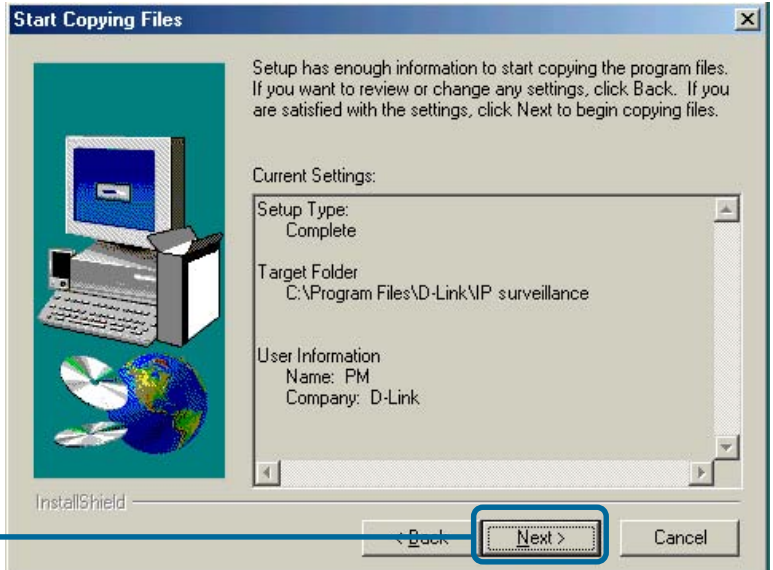

The installation is complete.

Testing the DCS-3220G Internet Camera

Open your Internet browser and type in the IP address of the **DCS-3220G**. In this example the address is: **http://192.168.0.12** (your **DCS-3220G** may have a different IP address based on what you used in the **IP Installer** program).

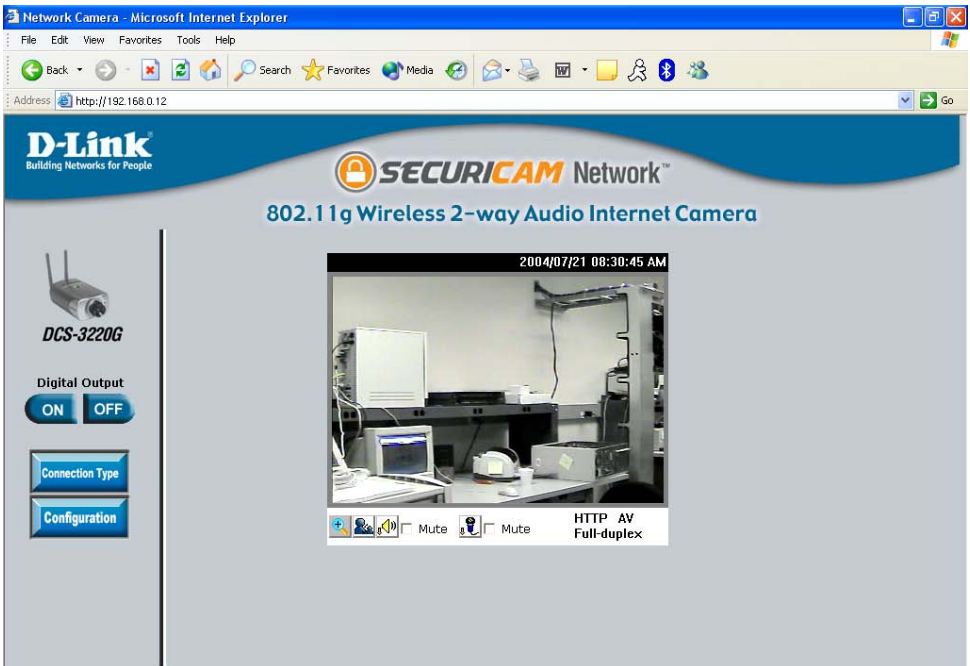

The window in the center of your browser is the camera image window. You should now see a video image and hear the audio over your computer speakers from the **DCS-3220G**. If you are having problems, please consult the **FAQ** section of this manual (page 124).

Security

At this point it is highly recommended that you click on the **Configuration** button on the Home screen, and then the **Tools** tab to bring you to the **Admin** screen. Enter a **password** for security purposes.

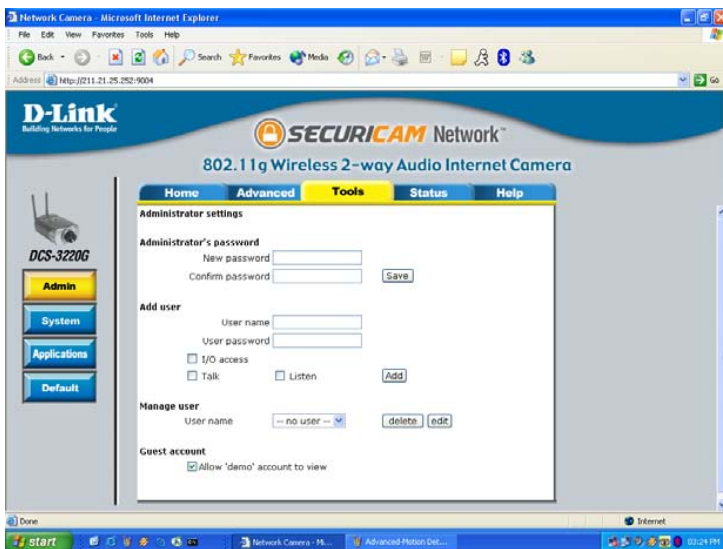

To ensure the highest security and prevent unauthorized use of the Internet Camera, the *Administrator* has the exclusive privilege to access the **System Administration** settings to allow users entry and authorize privileges for all users. The Internet Camera supports multi-level password protection/access to the Internet Camera that can be restricted to defined users who have a **User Name** and **User Password**, which is assigned by the Administrator.

The Administrator can release a public user name and password so that when remote users access the Internet Camera they will have the right to view the image transmitted by the Internet Camera.

When the Internet Camera is used for the first time, it is highly recommended that the Administrator set the **Administrator's Password** to constrain user access to the Internet Camera since the Default settings are Null String (no password). Once the Password is defined, only the Administrator has access to the management of the Internet Camera. This procedure should be done as soon as possible since the security features of the Internet Camera will not be enabled until the **Administrator Password** is defined.

Using & Configuring the DCS-3220G with a NAT Router

D-Link's **DCS-3220G** is a versatile and cost effective Internet Camera offering both video and audio monitoring. It can also serve as a powerful surveillance system in security applications. The **DCS-3220G** can be used with any wired or 802.11g wireless router. This section explains how to view the camera from either the Internet or from inside your internal network.

Materials Needed:

- 1 **DCS-3220G** Internet Camera
- 1 Ethernet Cable
- A Wired or Wireless router such as the D-Link DI-614+ Wireless Router
- Ethernet based PC for system configuration

SETTING UP THE DCS-3220G FOR USE BEHIND A ROUTER

Installing a **DCS-3220G** Internet Camera on your network is an easy 4–step procedure:

- ① Assign a local IP Address to your Internet Camera
- ② View the Internet Camera Using Your Internet Explorer Web browser
- ③ Access the Router with Your Web browser
- ④ Open Virtual Server Ports for Your Router (Enable Remote Viewing)

This section is designed to walk you through the setup process for installing your camera behind a router and enable remote video viewing. For the basic setup of the **DCS-3220G**, follow the steps outlined in the **Quick Installation Guide**.

After you have completed the setup of the **DCS-3220G** outlined in the **Quick Installation Guide** you will have an operating camera that has an assigned IP Address. Because you are using a router to share the Internet with one or more PCs, the IP Address assigned to the Internet Camera will be a local IP Address. This allows viewing within your Local Area Network (LAN) until the router is configured to allow remote viewing of the camera over the Internet.

① Assign a Local IP Address for Your Camera

Run the **IP Installer** program from the CD included with the **DCS-3220G**. Follow the steps in the **Quick Installation Guide** to configure the **DCS-3220G**. The camera will be assigned a local IP Address that allows it to be recognized by the router. Write down this IP Address for future reference.

Using & Configuring the DCS-3220G with a NAT Router (continued)

This is the IP Address assigned to your camera. Write it down for later use. 192.168.0.102 is only an example. You will probably have a different IP Address.

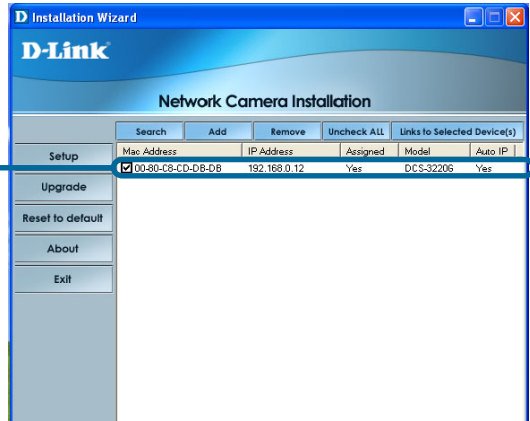

② View the Internet Camera using your Internet Explorer Web browser

Run your Internet Explorer Web browser. In the address bar, type in the IP Address that was assigned to the Internet Camera by the **IP Installer** program. The **DCS-3220G** Home Page appears with a window displaying live video from the camera. You are able to view this screen from any PC running Internet Explorer on your LAN.



Click on the **Configuration** button.

Viewing the Video on the browser to test the connection

Click on the **Configuration** button on the left side of the display. Scroll to the bottom of the Network Configuration page to display the ports used by HTTP and Streaming audio and video.

Using & Configuring the DCS-3220G with a NAT Router (continued)

These are the port settings for your camera. If necessary, these ports can be changed if they are already in use by other devices (e.g. in a multiple camera environment).

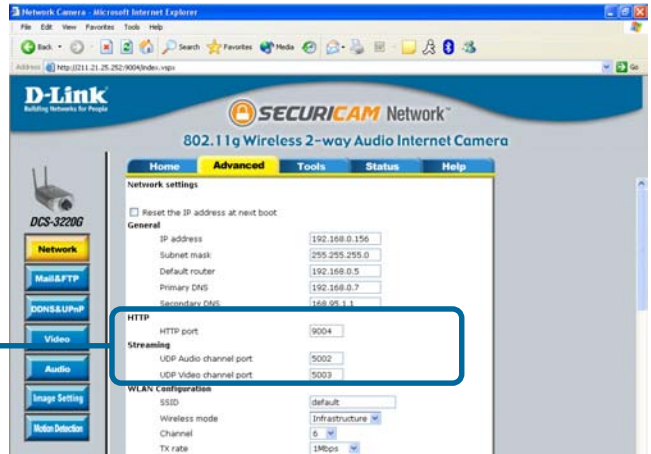

Ports that are used by the DCS-3220G

Router Set-Up and Installation

The following steps generally apply to any router that you have on your network. The D-Link DI-614+ is used as an example to clarify the configuration process. Configure the initial settings of the DI-614+ by following the steps outlined in the **DI-614+ Quick Installation Guide**.

③ Access Your Router on Your Web Browser

If you have cable or DSL Internet service, you will most likely have a dynamically assigned WAN IP Address. 'Dynamic' means that your router's WAN IP address can change from time to time depending on your ISP. A dynamic WAN IP Address identifies your router on the public network and allows it to access the Internet. To find out what your router's WAN IP Address is, go to the **Status** menu on your router and locate the WAN information for your router (as shown on the next page). The WAN IP Address will be listed. This will be the address that you will need to type in your Web browser to view your camera over the Internet.

Using & Configuring the DCS-3220G with a NAT Router (continued)

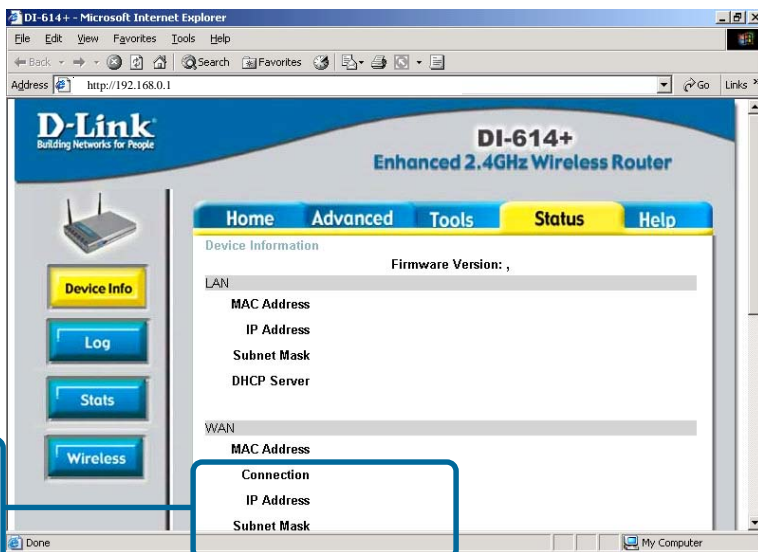

Determine Your Router's IP Address (WAN)

Note: Because a dynamic WAN IP can change from time to time depending on your ISP, you may want to obtain a Static IP address from your ISP. A Static IP address is a fixed IP address that will not change over time and will be more convenient for you to use to access your camera from a remote location. The Static IP Address will also allow you to access your camera attached to your router over the Internet

④ Open Virtual Server Ports to Enable Remote Image Viewing

The firewall security features built into the DI-614+ router prevent users from accessing the video from the **DCS-3220G** over the Internet. The router connects to the Internet over a series of numbered ports. The ports normally used by the **DCS-3220G** are blocked from access over the Internet. Therefore, these ports need to be made accessible over the Internet. This is accomplished using the **Virtual Server** function on the DI-614+ router. The Virtual Server ports used by the camera must be opened through the router for remote access to your camera. Virtual Server is accessed by clicking on the **Advanced** tab of the router screen.

Using & Configuring the DCS-3220G with a NAT Router (continued)

Follow these steps to configure your router's Virtual Server settings:

- Click **Enabled**.
- Enter a different name for each entry.
- Enter your camera's local IP Address (e.g., **192.168.0.102** in the example in step ② on page 28) in the **Private IP** field.
- Select **Both** under **Protocol Type** (TCP and UDP)
- If you are using the default camera port settings, enter **80** into the **Public** and **Private Port** section, click **Apply**.
- **Scheduling** should be set to **Always** so that the camera images can be accessed at any time.

Repeat the above steps adding ports **5002** and **5003** to both the **Public** and **Private Port** sections. A check mark appearing before the entry name will indicate that the ports are enabled.

Important: Some ISPs block access to port 80 and other commonly used Internet ports to conserve bandwidth. Check with your ISP so that you can open the appropriate ports accordingly. If your ISP does not pass traffic on port 80, you will need to change the port the camera uses from 80 to something else, such as 800. Not all routers are the same, so refer to your user manual for specific instructions on how to open ports.

Enter the ports in the **Virtual Server** section of your router that correspond to the ports you have configured on the **DCS-3220G**.

Please make sure to check the box on this line to enable settings

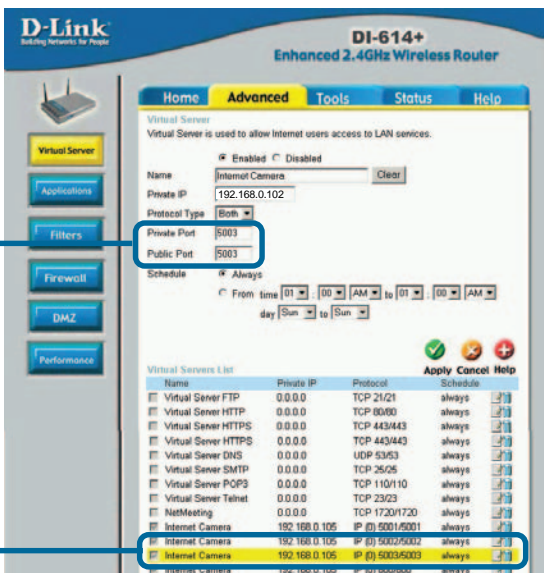

Viewing Your Camera

After all the router settings have been entered correctly, a PC user inside or outside your network will have access to the camera through the Internet Explorer Web browser. To access the camera from the Internet, type the IP Address of the router given to you by your ISP, followed by a colon, and the port number that you gave your camera (e.g., **http://205.163.122.96:83**). It is not necessary to enter the colon and port number if you are using the default Web server port 80. To access from a computer on your local (home) network, simply enter the local IP Address of the Camera followed by a colon and the port number (e.g., **205.163.122.96:83**).



Viewing the DCS-3220G

Using the DCS-3220G with an Internet browser

If you are following this manual in the order it is presented, you should now have an operating **DCS-3220G** Internet Camera configured with the Installer program. You also have installed the **IP surveillance** software from the CD. This section of the manual will deal with using the Internet Camera in two parts:

- Using the **DCS-3220G** with an Internet browser and accessing the screens to control and monitor the camera.
- Using **IP surveillance** software with the **DCS-3220G**.

Open your Internet Explorer Web browser and enter the IP address for your Internet Camera.

In the example, this address is 192.168.0.102. Your address may differ.

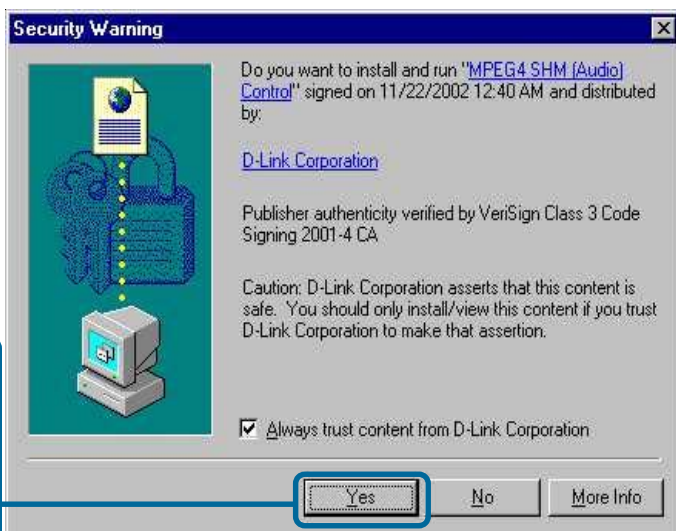

If a window appears asking to install a Verisign certificate for authentication Click **Yes**. This allows the proprietary MPEG 4 video stream to be recognized by Internet Explorer.

Using the DCS-3220G with an Internet browser (continued)

Home Page Screen

The image from the **DCS-3220G** should be visible from the Home page on your computer monitor. Below the image are controls that allow you to control zoom and two way audio functions.

Push/Toggle – Push to enable the speaker. You can set the speaker button operation to either Push or Toggle on the **Connection Type** screen. For additional information, please refer to the section titled **Home > Connections Screen** (page 36).

Speaker Volume Control – Click to increase or decrease speaker volume.

Mute Speaker – Click to mute the speaker.

Microphone Volume Control – Click to increase or decrease microphone volume.

Mute Microphone – Click to mute the camera's microphone.

+ – Opens digital zoom window.



Using the DCS-3220G with an Internet browser (continued)

Home Page Screen

The image from the **DCS-3220G** should be visible from the Home page on your computer monitor.

There are two buttons on the left side of the **Home** page:
Connection Type
and
Configuration.



Click on the **Connection Type** button to change settings related to the connection.

Click **Connection Type**



Using the DCS-3220G with an Internet browser (continued)

Home > Connections Screen

The following options are available from the Connections settings screen:

Media Option

Disable Audio - Option for users to disable or enable audio when viewing video.

Speaker button Operation - If Push is selected, the user must push and hold the speaker button each time to speak. If Toggle is selected, pushing the speaker button toggles the speaker function on and it remains on until the user toggles the button off.

Protocol Option

The user can select either UDP or HTTP as the connection protocol between the client and the server. The auto-detection order of transmission protocol is UDP -> HTTP.

After the client connects to the **DCS-3220G** successfully, the working protocol will be displayed in “**Protocol Option.**” The chosen protocol will be recorded in the user’s PC and used for the next connection. If the network environment is changed or users want to let the Web browser automatically detect the protocol, select UDP manually and click **Save** to change the setting and return **Home** to reconnect with the new setting.

Options:

UDP Protocol - Allows for more real-time audio and video streams. However, packets may be dropped and images obscured due to network burst traffic.

HTTP Protocol - This protocol must be selected if the network is protected by a firewall that only allows the HTTP Port (80) to be opened. If the user’s network does not require the use of a firewall, the UDP protocol is recommended.

Click the **Home** tab to return to the **DCS-3220G** Home page.



Using the DCS-3220G with an Internet browser (continued)

Home > Configuration

Click **Configuration**



There are 5 tabs across the top of the **Configuration** screen. From each tab, different elements of the **DCS-3220G** can be configured. The **Advanced** tab is the default screen in **Configuration** and **Network** is the default screen under **Advanced**.

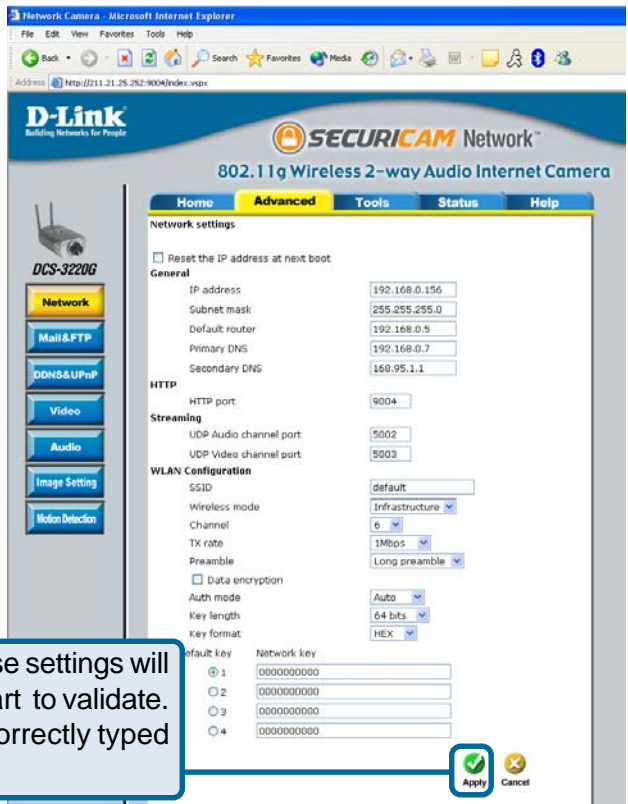

Any changes made to these settings will require the system to restart to validate. Make sure every field is correctly typed before clicking on **Apply**.

Using the DCS-3220G with an Internet browser (continued)

Configuration > Advanced > Network

Reset IP Address at next boot

Once the **DCS-3220G** is configured, this box should be unchecked at all times. If the box has been checked and the connection is lost, run **IP Installer** to find the camera's IP address.

General Settings

IP address -	Necessary for network identification.
Subnet mask -	Used to determine if the destination is in the same subnet. The default value is "255.255.255.0."
Default router -	The router used to forward frames to destinations in a different subnet. Invalid router settings may cause the failure of transmissions to a different subnet.
Primary DNS -	Primary domain name server that translates names to IP addresses.
Secondary DNS -	Secondary domain name server to backup the primary one.

HTTP Settings

HTTP Port-	Can be set to other than the default port 80. When the administrator changes the HTTP port of the DCS-3220G (which has an IP address of 192.168.0.100) from 80 to 8080, users must type http://192.168.0.100:8080 in the Web browser bar.
-------------------	---

Using the DCS-3220G with an Internet browser (continued)

Configuration > Advanced > Network Settings (continued)

Streaming Settings

- UDP audio port -** Can be set to a port other than the default port **5002**. A corresponding port must be opened on your firewall.
- UDP video port -** Can be set to a port other than the default port **5003**. A corresponding port must be opened on your firewall.
- Improve audio quality in low bandwidth environment -** In a low bandwidth network environment you can check this option to improve audio quality by sacrificing some real-time synchronization.

WLAN Configuration Settings

- SSID -** (Service Set Identifier) is a name that identifies a wireless network. Access Points and wireless clients attempting to connect to a specific WLAN (Wireless Local Area Network) must use the same SSID. The default setting is **default**.
- Wireless Mode-** Click on the pull-down menu; select from the following options:
Infrastructure - connecting the WLAN using an Access Point such as the DWL-1000AP+ or a DI-614+ wireless router. (The **default** setting.)
Ad-Hoc – wireless mode used when connecting directly to a computer equipped with a wireless adapter in a peer-to-peer environment.

Using the DCS-3220G with an Internet browser (continued)

Configuration > Advanced > Network Settings (continued)

- Channel -** The **default** wireless channel setting is channel 6. Select the channel that is the same as the other wireless devices on your network.
- TX Rate-** Select the transmission rate on the network. Auto is the **default** setting.
- Preamble-** Select **Long** or **Short Preamble**. The Preamble defines the length of the CRC block (Cyclic Redundancy Check is a common technique for detecting data transmission errors) for communication between the Access Point and the roaming wireless Network adapters. **Short Preamble** is the **default** setting. *Note: High network traffic areas should use the shorter preamble type.*
- Data Encryption -** Enable Encryption by clicking on the box. The **DCS-3220G** has Encryption disabled as the default setting.
- Auth mode -** Choose one of the following authorization modes:
- Open Authentication -** Communicates the key across the network.
 - Shared Authentication -** Allows communication only with other devices with identical WEP settings.
 - Auto -** Will automatically adjust to the Authentication mode of the wireless client.
- Key type -** Select the key length, either 64 or 128 bits.
- Key Format -** Select an ASCII or hexadecimal key format.
- Key Index -** You can create up to 4 different security keys.

Click **Apply** to make changes effective



Using the DCS-3220G with an Internet browser (continued)

Configuration > Advanced > Mail & FTP

Click the **Mail&FTP** button from the Configuration screen to access video settings that control sending images via e-mail and FTP.

The screenshot shows the D-Link configuration interface for the DCS-3220G camera. The main title is "SECURICAM Network" and the subtitle is "802.11g Wireless 2-way Audio Internet Camera". The navigation menu includes Home, Advanced, Tools, Status, and Help. The "Mail & FTP settings" page is active, showing fields for SMTP and FTP configurations. A callout box on the left points to the "Mail&FTP" button in the sidebar.

Field	Value
1st SMTP (mail) server	
1st SMTP account name	
1st SMTP password	
1st recipient email address	
2nd SMTP (mail) server	
2nd SMTP account name	
2nd SMTP password	
2nd recipient email address	
Sender email address	
Local FTP server port	21
1st FTP server	
1st FTP server port	21
1st FTP user name	root
1st FTP password	****
1st FTP remote folder	123456
1st FTP passive mode	<input type="checkbox"/>
2nd FTP server	
2nd FTP server port	21
2nd FTP user name	
2nd FTP password	
2nd FTP remote folder	
2nd FTP passive mode	<input type="checkbox"/>

SMTP

SMTP (mail) server 1 -

The domain name or IP address of external mail server.

SMTP account name 1 -

The user name used to log into your e-mail account (e.g. jdoe or jdoe@yourisp.com depending on your ISP).

SMTP password 1 -

The password used to log into your e-mail account. (The password will appear as dots instead of entered characters.)

Recipient email address 1 - The e-mail address of recipients for snapshots or a system log file. Multiple recipients must be separated by a semicolon “;”

SMTP(mail) server 2 -

The domain name or IP address of a secondary mail server used only if the primary mail server is unreachable.

Using the DCS-3220G with an Internet browser (continued)

Configuration > Advanced > Mail & FTP (Continued)

- SMTP account name 2 -** The user name for the second SMTP server.
- SMTP password 2 -** The password used to log into the second e-mail account. (The password will appear as dots instead of entered characters.)
- Recipient email address 2 -** The e-mail address of recipients for the secondary server.
- Sender email address -** The return e-mail address to use if the snapshot or system log e-mail fails to send. (This address should be within the SMTP server's domain for authentication purposes.)

FTP Settings

- Local FTP server port -** It can be other than default port 21. If you find that you want to change the port to a port number other than 21, you will need to specify the port when connecting to the FTP server. For example FTP://68.5.1.81:60 (if you are to use port 60 for your FTP server port)
- 1st FTP server -** The domain name or IP address of the external FTP server. The following user settings must be correctly configured for remote access.
- 1st FTP user name -** Granted user name on the external FTP server.
- 1st FTP password -** Granted password on the external FTP server.
- 1st FTP remote folder -** Granted folder on the external FTP server. The string must conform to the external FTP server. Some FTP servers cannot accept a preceding slash symbol before the path if there is no virtual path mapping. Refer to the instructions of the external FTP server for details. The folder privilege must be open for upload.

Using the DCS-3220G with an Internet browser (continued)

Configuration > Advanced > Mail & FTP (Continued)

Primary FTP Passive Mode-

If the **DCS-3220G** is located inside a network that is protected by a firewall, a data connection for FTP may be prohibited. Passive mode FTP can bypass this rule and allow the uploading of snapshots. If the passive mode is selected, the **DCS-3220G** can automatically attempt to upload in active mode if the external FTP server does not support passive mode.

2nd FTP server -

The domain name or IP address of the external FTP server. Note that this 2nd FTP server will only be used if the 1st FTP server is unavailable. If image upload to the 1st FTP server is successful, no attempts will be made to connect to the 2nd FTP server.

2nd FTP user name -

Granted user name on the backup FTP server.

2nd FTP password -

Granted password on the backup FTP server.

2nd FTP remote folder -

Granted folder on the backup FTP server.

Secondary FTP passive Mode -

Passive mode setting for the backup FTP server.

Click **Apply** to make changes effective



Invalid settings may cause the **DCS-3220G** to not respond. Change the configuration settings only if necessary. Consult with your network administrator or your Internet Service Provider (ISP) if you do not have the necessary information. If you cannot connect to the camera, refer to page 128 for camera **reset** and **restore** factory settings procedures.

Using the DCS-3220G with an Internet browser (continued)

Configuration > Advanced > DDNS & UPnP

Click the DDNS & UPnP button from the Configuration screen to access DDNS & UPnP settings.

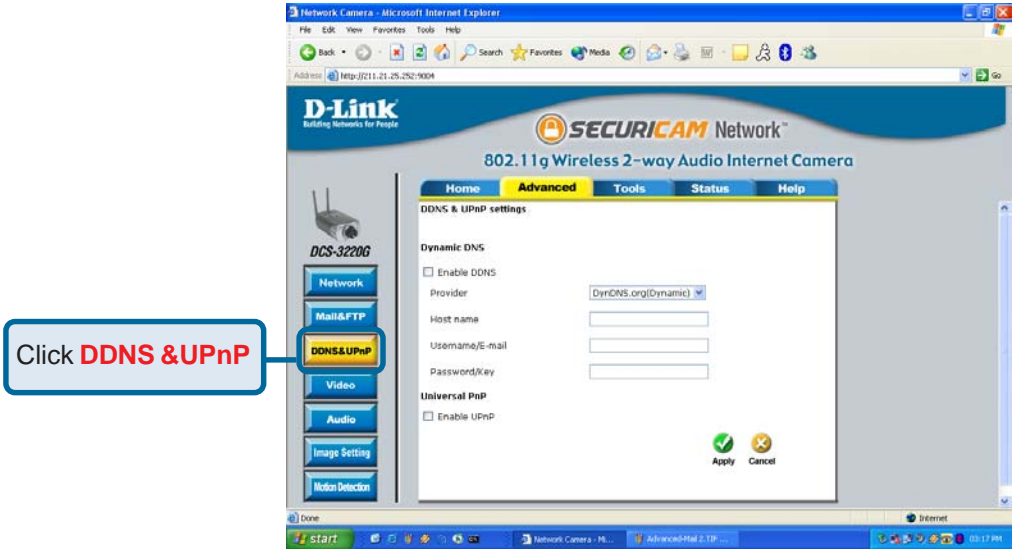

Dynamic DNS (DDNS)

Dynamic DNS (Domain Name Service) is a method of keeping a domain name linked to a changing (dynamic) IP address. With most Cable and DSL connections, you are assigned a dynamic IP address and that address is used only for the duration of that specific connection. With the **DCS-3220G**, you can set up your DDNS service and the **DCS-3220G** will automatically update your DDNS server every time it receives a different IP address. Depending on the service, this update may take a few hours.

Using the DCS-3220G with an Internet browser (continued)

Configuration > Advanced > DDNS & UPnP (Continued)

- Enable DDNS -** Click to enable the DDNS function.
- Provider-** Select your Dynamic DNS provider from the pull down menu.
- Host name-** Enter the host name of the DDNS server.
- Username/E-mail-** Enter your username or e-mail used to connect to the DDNS server.
- Password/Key-** Enter your password or key used to connect to the DDNS server.

UPnP

UPnP is short for Universal Plug and Play, which is a networking architecture that provides compatibility among networking equipment, software, and peripherals. The **DCS-3220G** is a UPnP enabled internet camera. If your operating system is UPnP enabled, the device will be easier to configure. If you do not want to use the UPnP functionality, it can be disabled by unselecting the Enable UPnP check box.

Click Apply to make changes effective



Using the DCS-3220G with an Internet browser (continued)

Configuration > Advanced > Video

Click the **Video** button from the Configuration screen to access video settings that affect how the video image appears.

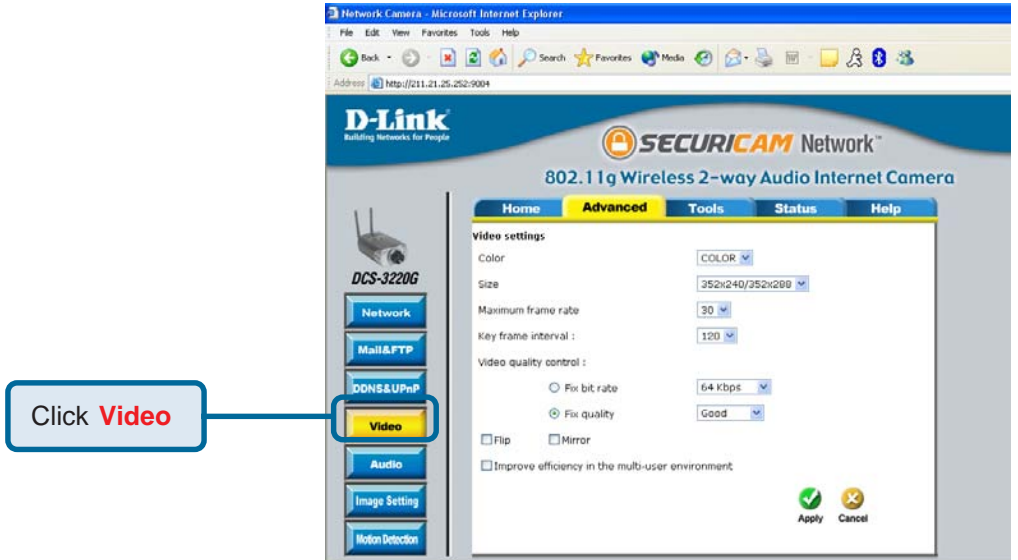

Color -

Select the option for color or monochrome video display.

Size -

Three options exist for the video display: 176 x 120, 352 x 240, and 704 x 480. In 704x480 mode, the frame rate will be reduced to 10 fps and increased to 30fps automatically when it is switched back to a lower image size.

Maximum frame rate-

Limits the maximum refresh frame rate. The frame rate is used with the **Video quality control** setting (below) to optimize bandwidth utilization and video quality.

Using the DCS-3220G with an Internet browser (continued)

Configuration > Advanced > Video (Continued)

- Video quality control-** To fix the bandwidth utilization regardless of the video quality, choose **Fix bit rate** and select the desired bandwidth. The video quality may be reduced in order to send maximum frames with limited bandwidth, especially when images change drastically. For higher video detail regardless of the bandwidth selection, select **Fix quality** and select a video quality level. This setting will utilize more bandwidth to send the maximum frames when images change drastically.
- Flip -** Vertically rotate the video.
- Mirror -** Horizontally rotate the video. Check both **flip** and **mirror** if the **DCS-3220G** is to be installed upside down.
- Improve efficiency in the multi-user environment -** If the camera works in a multi-user environment, the user can select this to conserve bandwidth by reducing video capture rate.

Click **Apply** to make changes effective



Using the DCS-3220G with an Internet browser (continued)

Recommendations for setting video for the best performance:

“Best performance” means the image refresh rate should be the fastest possible and the video quality should be the best possible at the lowest network bandwidth possible. Three factors, **Maximum frame rate**, **Fix bit rate**, and **Fix quality** in the **Video Configuration** page, are related to performance.

Recording settings for real-time motion images

To achieve a real-time visual effect, the network bandwidth should be large enough to transmit 20 image frames per second (fps) or more. If you are on a broadband network over 1 Mbps, you can set **Fix bit Rate** to 1000Kbps or 1200Kbps, or set **Fix quality** to achieve the maximum frames. The maximum frame rate is 25 in 50Hz system and 30 in 60Hz system. If your network bandwidth is more than 384Kbps, you can adjust **Fix bit rate** according to your bandwidth and set the maximum frame rate of 25 to 30.

If the images vary dramatically in your environment, you may slow down the maximum frame rate to 20 to decrease the transmitted data for better video quality. Since the human eye could not easily differentiate between 20 and 25 or 30 frames per second, the slower frame rate will not be noticed. If your network bandwidth is below 384 Kbps, you should adjust the bit rate according to your bandwidth and experiment to allow for the best frame rate that can be achieved. The faster frame rate in a slow network will blur the images. You may also try to choose **352x240** in size option for better images or **704x480** for larger image size. Because the network has burst constraints and everyone's environment is not the same, any poor connection will impair normal performance.

Recording settings for clear identification for each image

To have the best video quality, you should set **Fix quality** to **detailed** or **excellent** and tune the **Maximum frame rate** to suit your network bandwidth. Note that any slow connection with multiple users will impair performance.

Using the DCS-3220G with an Internet browser (continued)

Recommendations for setting video for the best performance (continued):

Recording Settings to compromise between real-time and clear images

If you have a broadband network, set **Fix quality** to **Good** image quality, or higher, instead of setting the **Bit rate**. Otherwise, fix the bit rate according to your actual network speed and set the frame rate to 30. If the image quality is low, select a lower frame rate above 15.

Configuration > Advanced > Image Setting

Click **Image Setting**

Click the Image Setting button from the Configuration screen to access additional settings that affect how the video image appears.

Using the DCS-3220G with an Internet browser (continued)



From this screen you can fine tune the video image.

Image **Brightness**, **Contrast**, **Saturation** and **Hue** are all adjusted in the same manner. For each video compensation you can set from among eleven levels ranged from -5 to +5. The default setting is zero for each adjustment.

You may press **preview** to fine-tune the image and see what affect the setting will have on the image. When the image is acceptable, press **Save** to store the image settings, or **restore** to recall the original settings. If settings are changed without saving, they will be used until the next system start-up.

Configuration > Advanced > Motion Detection

Click the **Motion Detection** button from the **Configuration** screen to access settings that affect how the **DCS-3220G** Internet Camera can serve as a security device by recording only when motion is detected.



Click **Motion Detection**

Using the DCS-3220G with an Internet browser (continued)

Configuration > Advanced > Motion Detection (continued)

Enable motion detection - Check this option to turn on the motion detection.

Window Name - The text entered here will show at the top of the motion window.

Sensitivity - Sets the measurable difference between two sequential images that would indicate motion.

Percentage - Sets the amount of motion in the window being monitored that is required to initiate a motion detected alert. If this is set to 100%, this means that motion is detected within the whole window to trigger a snapshot.

Note: Setting a higher **sensitivity** and a lower **percentage** makes any motion more easily detected.

New - Click to add a new window. A maximum of three motion windows can be opened simultaneously. Use your mouse to drag the window frame to resize or the title bar to move. Clicking on the 'x' at the upper right corner of the window will close the window.

Save - Saves the related settings of that window.

To display motion detection, a graphic bar will rise or fall depending on the image variation.



A green bar means the image variation is under the monitoring level, and no motion detection alert is triggered. A red bar means the image variation is over the monitoring level and a motion detected alert is triggered. When the bar goes red, the window that the motion is detected in will also be outlined in red (note: remember that you can have up to 3 windows selected for motion detection). You can return to the **DCS-3220G** Home Page and the monitored window will not be visible, but the red frame will show on the home page when motion is detected.

Using the DCS-3220G with an Internet browser (continued)

Configuration > Tools > Admin

Click on the **Tools** tab to access 4 utility screens for controlling and administering the **DCS-3220G**. The default screen in **Tools** is the **Admin** screen.



The **DCS-3220G** is manufactured without any passwords by default. This allows the ability to access the **DCS-3220G** (including the Configuration) by anyone as long as the IP address is known. It is recommended that you enter a password to restrict others from accessing your camera.

Type a password in the **New Password** field to enable protection, and then confirm the password in **Confirm Password** field.

This password is used to identify the administrator. You can add accounts with **User name** and **User Password** for other users in the **Add user** section.

You can provide up to twenty accounts for other users / visitors. Each account identifies the access right. This allows multiple visitors to share the same account of different levels. An option to **Permit to access DI/DO** (Digital In/Digital Out) is provided for each account. Some users may need to be prohibited from controlling your attached security devices.

Using the DCS-3220G with an Internet browser (continued)

Configuration > Tools > Admin (continued)

Guest account: This option allows a user to connect to a camera with view-only privileges. User name is **demo**. No password is required. This is useful for demonstrations and keeps guests separate from users with accounts.

Configuration > Tools > System

Click on the **System** button to access the System settings from the **Tools** menu.

The screenshot shows the D-Link Securicam Network web interface. The browser title is "Network Camera" and the address bar shows "http://11.21.25.252:9004". The page header includes the D-Link logo and "SECURICAM Network". The main heading is "802.11g Wireless 2-way Audio Internet Camera". The navigation tabs are "Home", "Advanced", "Tools", "Status", and "Help". The "Tools" tab is selected, and the "System settings" section is visible. The "Camera name" field is empty. Below it is a checkbox for "Turn off the LED indicator". There are three radio button options: "Keep current date and time" (selected), "Sync with computer time", and "Manual". The "Manual" option has fields for "Date" (2004/07/21) and "Time" (08:59:42). The "Automatic" option has a text field for "NTP server" (skip to invoke default server), a dropdown for "Time zone" (GMT+8:00), and a dropdown for "Update interval" (One hour). "Apply" and "Cancel" buttons are at the bottom right.

Camera name -

The text will display as the title of the window within the Windows operating system. This name will also display on the log-in screen (once a password has been set). Illegal characters (*, &, /) are not allowed and may render the recording feature in IP surveillance (page 65) useless for that camera.

Turn off the LED indicator -

Check this option to shut off the LED next to the lens. This will prevent anyone from observing the operation of the Internet Camera.

Using the DCS-3220G with an Internet browser (continued)

Configuration > Tools > System

Keep current date and time -

Click to save the current date and time of **DCS-3220G**. An internal real-time clock maintains the date and time even when the power is off.

Sync with computer time-

Synchronize the date and time of **DCS-3220G** with the local computer. The date and time of the PC is displayed and updated in the **DCS-3220G**.

Manual -

Adjust the date and time according to what is entered by the administrator. Notice the format in the related field while typing.

Automatic -

Synchronize with the NTP server over the Internet whenever the **DCS-3220G** starts up. It will fail if the assigned timeserver cannot be reached.

NTP server -

Assign the IP address or domain name of the timeserver. Leaving the text box blank will let the **DCS-3220G** connect to default time servers.

Time zone -

Used to adjust the hour of time servers for local settings.

Click **Apply** to make changes effective



Using the DCS-3220G with an Internet browser (continued)

Configuration > Tools > Applications

Click on the **Applications** button to access the Applications settings from the **Tools** menu.

Network Camera - Microsoft Internet Explorer

File Edit View Favorites Tools Help

Address: http://211.21.25.252:9004

D-Link
Building Networks for People

SECURICAM Network™

802.11g Wireless 2-way Audio Internet Camera

Home Advanced **Tools** Status Help

Applications settings

Weekly schedule

Sun Mon Tue Wed Thu Fri Sat

snapshots begin at [hh:mm:ss]

snapshots stop at [hh:mm:ss]

All the time except for the above schedule

Snapshot interval: second(s)

Event operation

General

Delay second(s) before detecting the next event

Trigger condition

Input is high Input is low

Input is rising Input is falling

Detect motion in :

Note: **Motion detection** must be setup first

Trigger action

Trigger output alarm while input condition matched

Trigger output alarm while motion detected

Upload snapshots while input condition matched

Upload snapshots while motion detected

Reset output

Sequential operation

Send snapshots by email

Send snapshots by FTP

FTP put snapshots with date and time suffix

Apply **Cancel**

Using the DCS-3220G with an Internet browser (continued)

Configuration > Tools > Applications (Continued)

Weekly schedule:

Sunday through Saturday - Select the weekdays that should perform the following operations:

Snapshots begin at - Set the time to start operations. Setting the **begin** time the same as the **stop** time will force the operations to run continuously.

Snapshots stop at - Sets the time to stop the operations.

All the time except for the above schedule - If you do not wish to set a schedule, this box must be checked.

Snapshot Interval - Interval of time between each sequential snapshot.

Event operation:

Delay second(s) before detecting next event - Sets the time delay before restarting to check the trigger condition when the current condition is triggered.

Take snapshots at second(s) after event - After a snapshot is taken because of a trigger, another snapshot will be taken after the configured time in seconds.

Trigger condition - There are 4 conditions related to the digital input and three windows for motion detection. There can be multiple selections. Select the appropriate digital input condition according to the characteristics of the external device. **High** or **low** indicate external voltage input for level trigger, while **rising** or **falling** is for edge triggers. There are three windows shown for the names you defined for motion detection. **Undefined** will show instead of the window title if motion detection is not setup yet. An active, named motion window must be checked for motion detection to be possible.

Using the DCS-3220G with an Internet browser (continued)

Configuration > Tools > Applications (Continued)

Reset output - Check and save this option to reset the external device at the digital output back to the original state.

Trigger action - There are four options for two actions regarding either trigger condition. They can have multiple selections. While choosing the trigger output alarm, the digital output will short both pins to connect the circuit of the attached external device; otherwise both pins will be open. While choosing to upload snapshots, the method can be either email or FTP. The snapshot names will be “videopre.jpg”, videotrg.jpg”, and “videopos.jpg” respectively for the snapshots before event, right upon event, and after event. The date and time suffix may be added according to the option. Confirm the external mail or FTP server settings in network configuration.

Sequential operation

Snapshot every second(s) - The camera will send snapshots at the specified interval to the external server according to the chosen method. Remember this operation is dependent to the weekly schedule.

Send snapshots by email - Any upload action specified in the options above will use the method chosen here. The captured snapshot named “video.jpg” will be attached in the email with subject “Periodic snapshots.”

Send snapshots by FTP - The captured snapshots will upload to the external FTP server with the file name depending on the next option.

Using the DCS-3220G with an Internet browser (continued)

Configuration > Tools > Applications (Continued)

FTP put snapshots with date and time suffix -

If the suffix is added, the captured date and time can be easily differentiated from the snapshot file name in either sequential or event operation. For instance, “video@20020102030405.jpg” means the JPEG image was captured at 4 minutes and 5 seconds after 3 o'clock, January 2nd, A.D. 2002. If the suffix is omitted, the file named “video.jpg” on the external FTP server will be refreshed at the specified interval.

Click **Apply** to make changes effective



Configuration > Tools > Default

Click on the **Default** button to access the option to restore to factory default settings.



Click **Default**

Click **Apply** on this screen to restore factory default settings. This means any changes made will be lost and the system will be reset to the initial status when shipped from the factory. After confirmation, the system will restart and require the **Installation Wizard** software program to locate the IP address of the **DCS-3220G**.

Using the DCS-3220G with an Internet browser (continued)

Configuration > Status > Device Info

Click on the **Status** tab to access **Device Info** and a **Log** of **DCS-3220G** system activity. The **Device Info** is the default screen when you click on the **Status** tab.



The Device Info screen lists the following important settings that are currently set for the **DCS-3220G**:

- Firmware Version number
- Mac address
- IP address
- Subnet Mask
- Default router address
- Primary DNS address
- Secondary DNS address

Using the DCS-3220G with an Internet browser (continued)

Configuration > Status > Log

Click on the **Log** button to access a system log of system activity from the **Status** menu. The content of the log file reveals useful information about the current configuration and connection logged after the **DCS-3220G** boots up.



Configuration > Help

Click on the **Help** tab to access descriptions of the particular function you need help with. The help screen is organized in the order of the tabs and then each menu item under that tab.

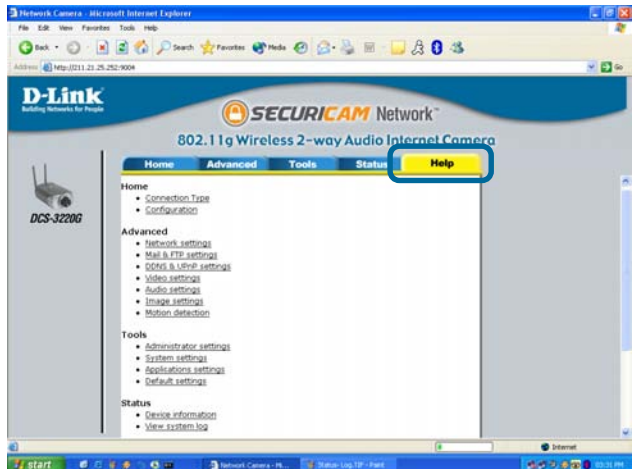

Record Snapshots to your FTP server

Administrators can combine options on the application page to perform many useful security applications. There are two trigger sources available: from an external sensor or with built-in motion detection. There are also two kinds of actions that can respond to these events that include uploading snapshots over the internet and driving attached devices. To upload the snapshots, users can choose either email or FTP according to user's needs. Both e-mail and FTP use the network settings on the network page. This section describes how to enable motion detecting and record snapshots to an FTP server.

If no external sensor is available, administrators can utilize the built-in motion detection to monitor any abnormal movement and then record the snapshots to an FTP server.

Click the **Motion Detection** button under the **Advanced** tab from the **Configuration** screen to access settings that affect how the **DCS-3220G** Internet Camera can serve as a security device by recording only when motion is detected.



In this window, follow the steps below to ensure that motion detection is correctly enabled:

- 1 Check "Enable motion detection."
- 2 Click on "New" to have a new window to monitor video.
- 3 Enter in a window name.
- 4 Tune the "Sensitivity" and "Percentage" according to the local environment. The highest sensitivity and lowest percentage provides the most sensitive settings.
- 5 Click on save to enable the activity display.

Record Snapshots to your FTP server (continued)

Next, click the **Mail & FTP** button under the **Advanced** tab to set the FTP server settings for the **DCS-3220G**.



In this window, enter the settings for the FTP server you wish to record to. Optionally, you can enter settings for a secondary backup FTP server.

① **Local FTP server port-** The Default port is 21. To connect to an FTP sever, it is recommended that you do not change the port number unless your camera is behind a router. If your camera is behind a router, you can assign any port number to this field, but you must enable port forwarding on the router. Please refer to your router manual for more information on port forwarding.

② **1st FTP server-** If you are going to upload snapshots to an FTP server, you will need to fill in the Domain name or IP address of your external FTP server such as ftp://dlink.com or ftp://123.123.123.1. (The server name and IP address will vary depending on the user.) The following user settings must be correctly configured for remote access.

Record Snapshots to your FTP server (continued)

- | | |
|-----------------------------|--|
| ③ 1st FTP server port- | The port of the FTP server. The default is 21 for an external FTP site. |
| ④ 1st FTP user name- | Specify the user name to access the external FTP server (e.g. John Smith). |
| ⑤ 1st FTP password- | Specify the password to access the external FTP server (e.g. 12345). |
| ⑥ 1st FTP remote folder- | Specify the destination folder in the external FTP server (e.g. 123456). |
| ⑦ Primary FTP passive mode- | Passive mode will allow access to an external FTP server if your camera is behind a router protected by a firewall. |
| 2nd FTP server- | Specify the Domain name or IP address of your second external FTP server. This field is optional if you have already filled in the information for the first FTP server. |
| 2nd FTP server port- | The port of the FTP server. The default is 21 for an external FTP site. |
| 2nd FTP user name- | Specify the user name to access your backup FTP server. |
| 2nd FTP password- | Specify the user password to your backup FTP server. |
| 2nd FTP remote folder- | Specify the destination folder on your external backup FTP server. |
| Secondary FTP passive mode- | Passive mode will allow access to a second external FTP server if your camera is behind a router protected by a firewall. |

For detailed information about each setting, please refer to **Configuration > Advanced > Mail & FTP** in the section titled “Using the DCS-3220G With an Internet Browser” (page 33). Click the apply button when finished.

Record Snapshots to your FTP server (continued)

Next, click the **Applications** button under the **Tools** tab to set the application settings for the **DCS-3220G**.

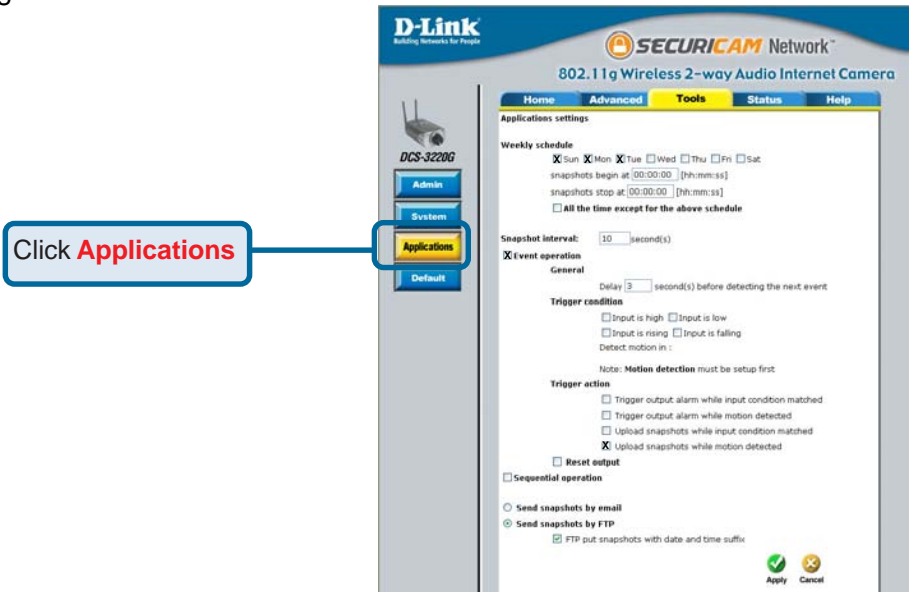

In this window, follow the steps below to set the application settings for snapshots to be recorded to an FTP site:

- 1 Select the weekdays you would like to record and enter the “Snapshots begin” time and “Snapshots end” time for the weekly schedule, or select “All the time except for the above schedule” if you want to enable full time snapshot recording.
- 2 Check “Event operation.”
- 3 Set the delay “before detecting next event” to avoid continuous false alarms following the original event.
- 4 Set the “Snapshot Interval” to capture the direction of the moving object.
- 5 Check the window name.
- 6 Check “Upload snapshots while motion detected.”
- 7 Click “Send snapshots by FTP” and check “FTP put snapshots with date and time suffix.”
- 8 Click the “Apply” button to save the settings.

Click the apply button when finished. You are now able to record snapshots to your FTP server when motion detection is triggered.

Using IP surveillance Software

Installing the IP surveillance Software

Hardware System Requirements

Before you begin installing this application software, the hardware system requirements must be checked first. The minimum system requirements recommended for this application are as follows:

Browser: Internet Explorer 5.x or above

CPU: Intel Pentium 4 1.7GHz or above

(Pentium 4, 2.8GHz plus processor with 512MB memory and a 32MB video card is required for multiple camera viewing and recording in IP Surveillance)

SDRAM: 128 MB SDRAM

Hard Disk: 40GB

Video Card: nVidia, TNT, TNT2, GeForce series with 32MB video memory / ATI Radeon series with 32 MB video memory

Software Installation

Put the installation disk into your CD-ROM, and it will run automatically. If it does not, open “My Computer” and double click on the CD-ROM icon. Next the installation menu will appear. Click “Install Software.” The following window will appear.

D-Link
Building Networks for People

DCS-3220G
SECURICAM Network™
2-Way Audio/Digital Zoom
802.11g Wireless
Internet Camera

This Installer will guide you through the installation process. You are only moments away from using your new D-Link Networking Product.

Thank You for Purchasing Your D-Link Product

- ▶ Installation Wizard
- ▶ **IP surveillance**
- ▶ Install Adobe® Reader®
- ▶ Install ZoneAlarm® Pro
This service is available for US Customers Only
- ▶ Visit support.dlink.com

◀ Back Exit ▶

Using IP surveillance Software (continued)

Installing the IP surveillance software (continued)

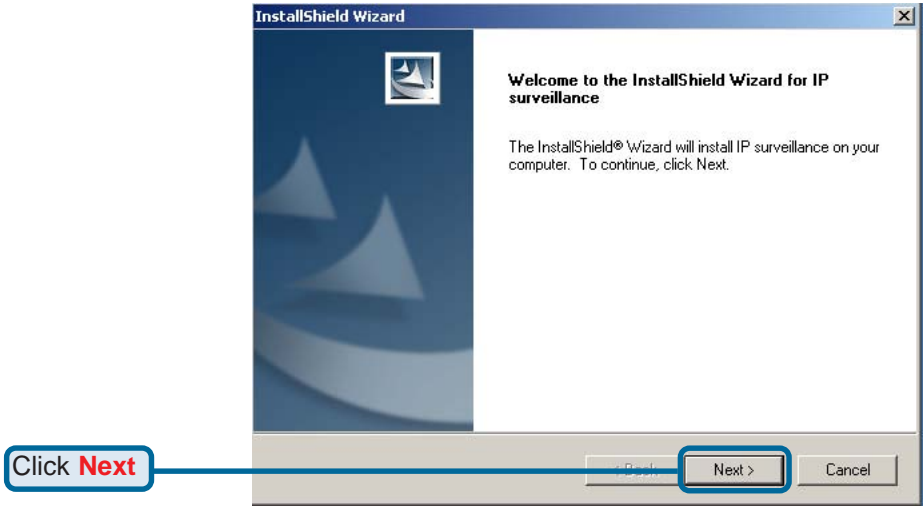

The “License Agreement” window below will appear. Please read the following license agreement carefully. Click “Yes” to accept this agreement and proceed with the installation.

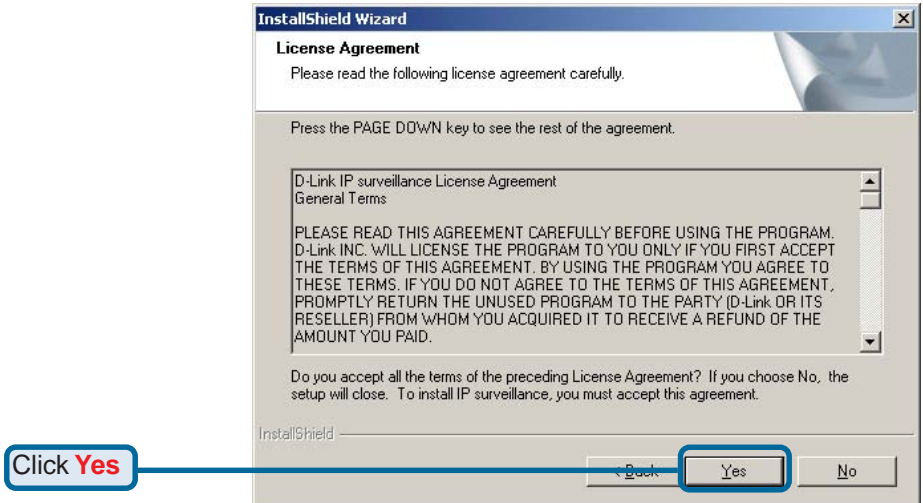

Using IP surveillance Software (continued)

Installing the IP surveillance software (continued)

Next, the “User information” window below will appear. This window will prompt you to enter the user name and company name. Enter your user name and company name and then click “Next” to continue.

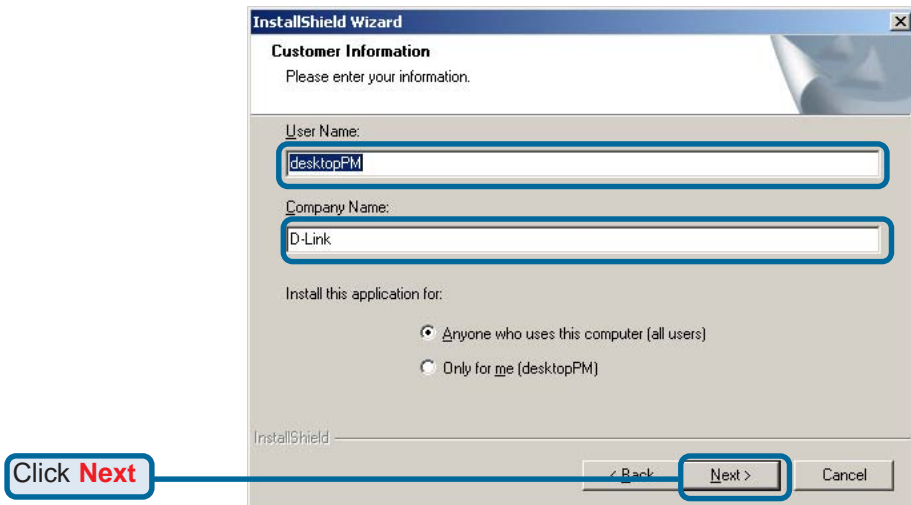

You must setup the administrator’s password in order to proceed. Input and confirm your password in the window shown in below. Click “Next” to continue.

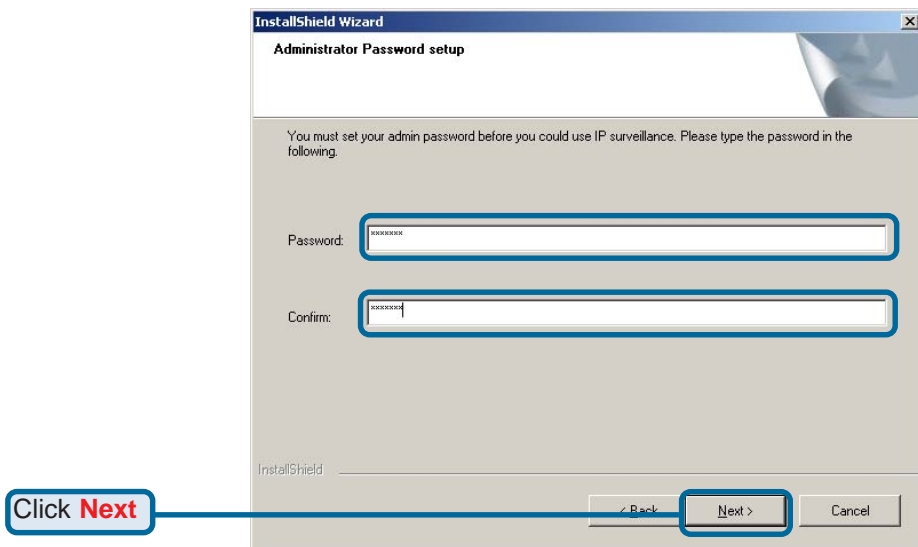

Using IP surveillance Software (continued)

Installing the IP surveillance software (continued)

Select the installation directory for this application software and click “Next”, which is shown in the figure below. You can change the installation directory by clicking “Browse...”

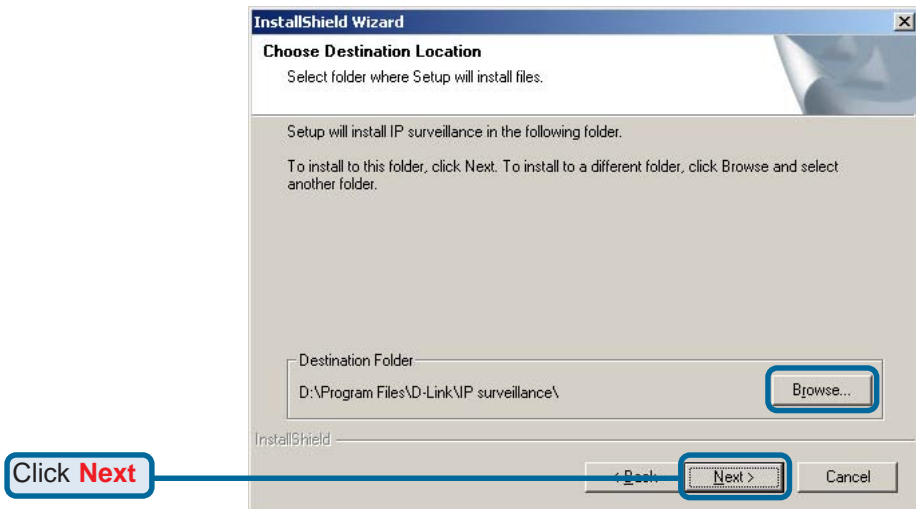

Select a program folder to install the application software and then click “Next”, which is shown in the figure below.

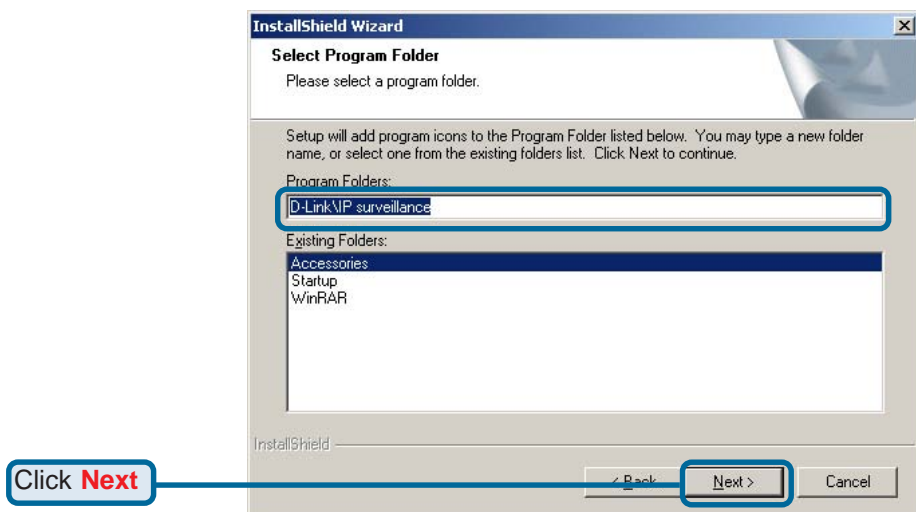

Using IP surveillance Software (continued)

Installing the IP surveillance software (continued)

After checking all the setup information in the window shown below, click “Next” to start the installation of the application.

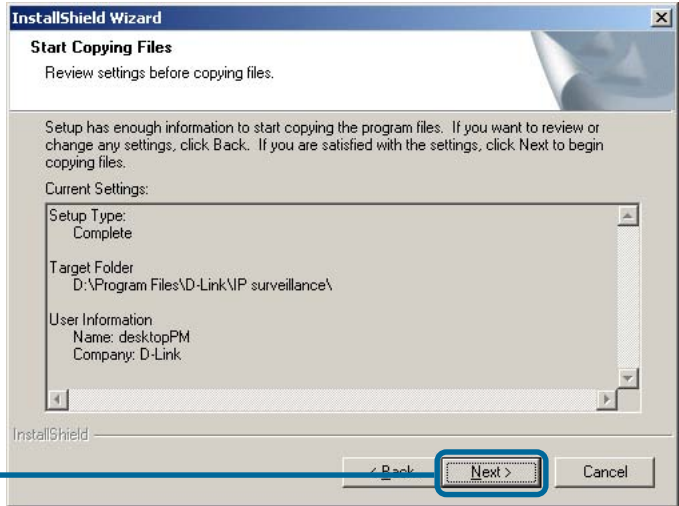

Click “Finish”, in the window shown below, to finish installation. The program is now installed on your computer.

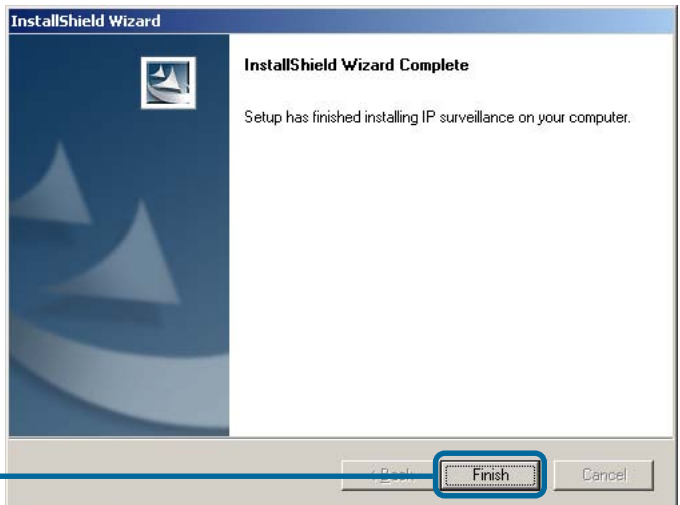

Using IP surveillance Software (continued)

Launcher

Launcher is a controller program that allows users to invoke Monitor or Playback quickly.

System Tray Icon

The Launcher icon reflects current state of IP surveillance. The  icon in the system tray signifies that the IP surveillance Software is currently active on the system.

Security for Launcher

When Launcher starts, there is no need to undergo a username/password check. But when users want to click on the icon of Launcher on system tray, Launcher will popup a username/password dialog the first time for menu popup or when Launcher is locked. If a user fails to pass the authentication check, no menu will show up. If a user fails 3 consecutive tries he/she will be locked out for a period of 60 seconds.

After passing authentication, users will be able to use all functions. If users want to leave the computer, it is possible to lock the Launcher for security reason. When Launcher is locked, the user will need to pass authentication again to see the popup menu.

Below is the login window:

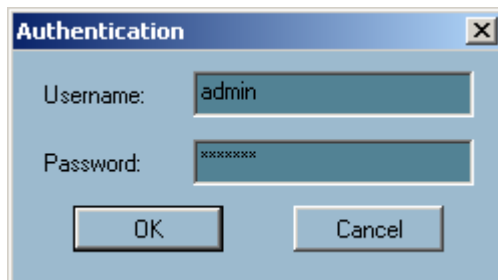

Using IP surveillance Software (continued)

Launcher (continued)

When Launcher is locked, the unlock window will appear, prompting for the user password in order to unlock.

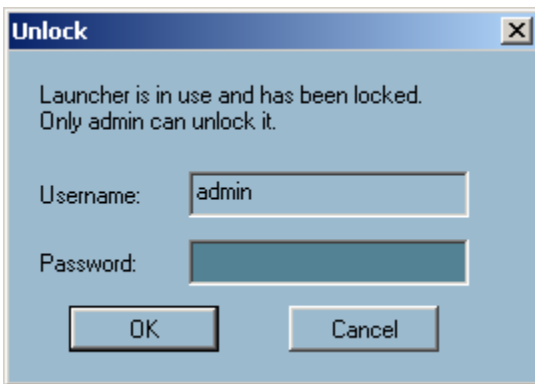

The input area of the dialog will be grayed (disabled) for 60 seconds after 3 consecutive failures.

User Interface

Below is the user interface for Launcher:

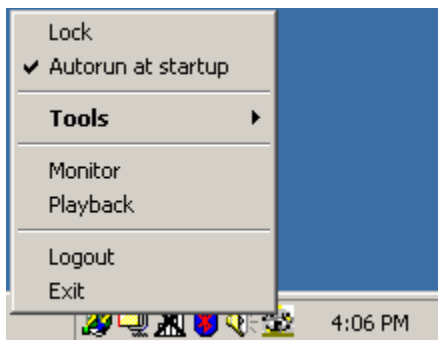

The main user interface for Launcher is an icon on system tray, and the popup menu appears when the user clicks on the icon. The menu items are listed below:

- **Lock Launcher**

When this item is selected, Launcher will enter lock mode. In lock mode, whenever users want to invoke the menu, a dialog asking for ID and password will appear. The interface for this dialog is covered in previous the section.

Using IP surveillance Software (continued)

Launcher (continued)

■ Tools

Contains many utilities. Currently only change password is implemented. The change password dialog looks like this:



■ Autorun at Startup

Users can select whether or not to autorun Launcher when Window boots up.

■ Monitor

Starts up the Monitor program. If the Monitor program is already running, clicking this button will re-open the Monitor window.

■ Playback

Starts up the Playback program. If the Playback program is already running, clicking this button will re-open the Playback window.

■ Logout

Logs out user from IP surveillance. After logging out, if the user wants to return to the menu, and clicks the Launcher icon, the authentication box will appear prompting for username and password again.

■ Exit

Exits Launcher. If users choose this option, Launcher will show a message box prompting to confirm if users really want to exit, and warn users that exiting Launcher will also close Monitor and Playback.

Using IP surveillance Software (continued)

Monitor Program

Features of the Monitor Program

Traditional Surveillance Features:

- Real-time monitoring
- Pan and Tilt control
- Recording

Special Features:

The digital surveillance system supports not only the features listed above, but also the following features, which make the system more powerful and convenient.

- Simultaneous real-time monitoring and recording audio and video
- High quality video up to full screen display
- High compression ratio
- Maximum of 16 cameras with different monitor layouts
- Auto alarm in multiple modes
- Account-password protection
- Multiple recording modes: Event-driven, Scheduled, and manual recording for each camera.
- Just-in-time snapshot
- Motion detection with 3 alert windows for each camera

Using IP surveillance Software (continued)

Monitor Program (continued)

Application Layout and Functionalities

This section demonstrates a global view of the monitor program, shown below. The components of the monitor tool will be introduced in detail in the following sections.

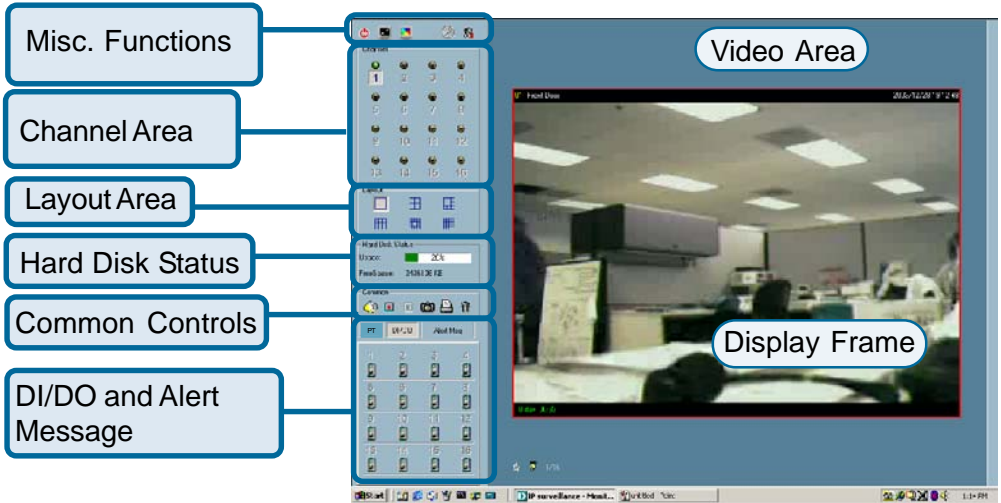

There are several parts in the monitor tool:

- **Misc. functions:**
These include application exit, minimization, full screen monitoring, lock, stop alert, and configuration menu for camera configurations, global settings, scheduler settings and the user information of this application software. Tips for these operations are provided when you move the mouse cursor over each icon.
- **Channel area**
This area displays the status of each video channel. The information indicates the status of connection, recording, selection, and alert-event trigger.
- **Video area**
In this area, you can see the video of the selected channel in the display frame. The number of the display frames in the video area depends on the layout chosen by the user. You can also use convenient controls to alter the video display.

Using IP surveillance Software (continued)

Monitor Program (continued)

- **Layout area**

You can change the monitoring layout in this area. There are six kinds of layouts: 1, 4, 6, 9, 13, or 16 video display windows in the video area.
- **Hard disk status**

In this area, you can get the status of the hard disk in which the video database resides. The status reminds you to arrange the available storage size of the recorded video database.
- **Common control area**

This area includes volume control, manual recording, video printing, snapshot, and trash can to remove video from display windows.
- **DI/DO control**

This tool receives the digital input signal and sends digital output signal to the remote Video Server/ Network Camera series product associated with the dedicated video channel.
- **Alert Message**

This tool will display the latest alert messages received by the remote Video Server / Network Camera series product associated with the selected video channel.

Logging In

You need to login the first time when you start the Launcher. The authentication window is shown below. If you do not have an account, the monitor tool will not execute. You must log in as admin (administrator) to use this application. Enter the password for the administrator.

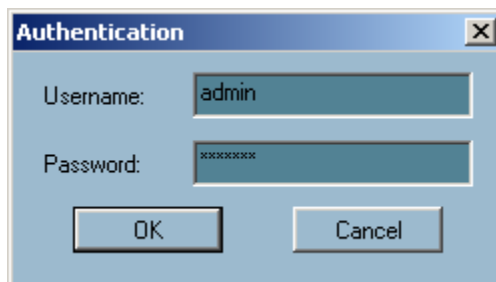

Using IP surveillance Software (continued)

Monitor Program (continued)

The Admin Privilege

In the Monitor program, the admin has the right to access the **DCS-3220G** Network Camera through this application software and change the local settings as well. But the admin password for the software is not the same as the admin password for the Internet camera. You can change the settings of each selected Internet camera from the Monitor program only if you have the admin password for the Internet camera.

If you have the admin privilege, you have the right to do the following tasks:

- Run the configuration tool
- Change the recording schedule
- Change the local settings

Again, if you need to change the settings of the **DCS-3220G**, you must have the administrator's password for the camera itself.

Camera Configurations

When you log in for the first time, you should configure this application software to connect the **DCS-3220G** in "Configuration Menu > Camera Configurations", shown in the figure below. You will need the admin (administrator) password of the camera in order to run the configuration.

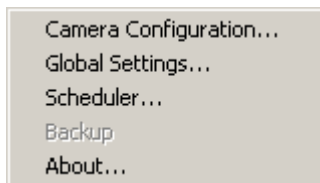

Once you click "**Configuration Menu > Camera Configurations**" for setting each camera, all recording processes will be stopped indicated by a warning window popped up in advance to keep you informed.

Using IP surveillance Software (continued)

Monitor Program (continued)

The Layout of the Configuration

This section discusses the local settings for the connection and the functional configuration of each camera. If you are interested in the remote settings for each camera, you can refer to “Using the DCS-3220G With an Internet Browser” (page 33).

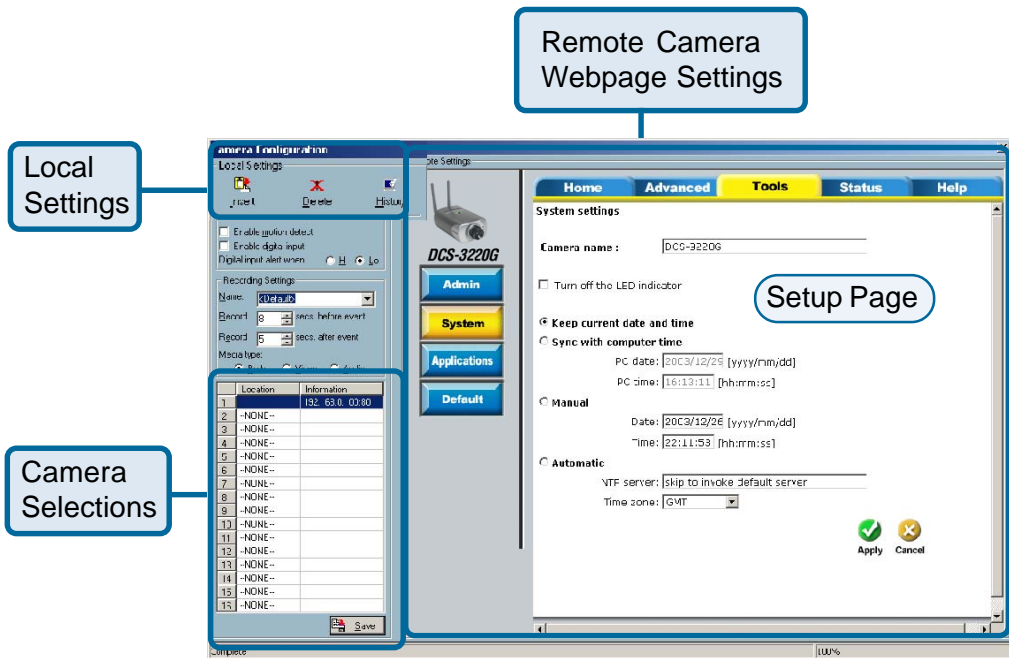

The Layout of the Configuration

In the local settings, shown below, three main functionalities are provided:

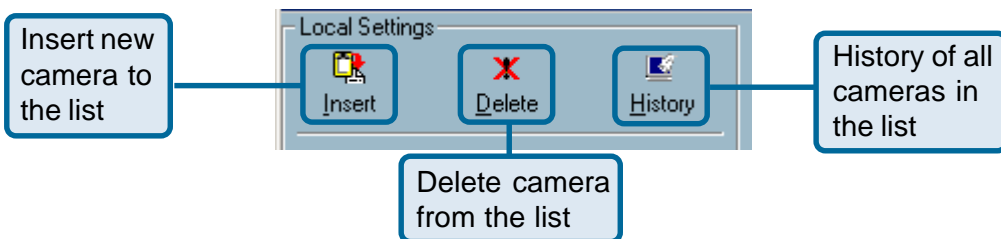

Using IP surveillance Software (continued)

Monitor Program (continued)

Insert – To insert a remote network camera to the camera list. Click the “Insert” button, an “Insert New Channel” dialog will popup, as shown below. Specify the IP address, port, and admin password of the network camera, click the “Ok” button to close the dialog. Then the system will try to connect to the selected camera. If the connection succeeds, the camera will be inserted to the camera selection list.

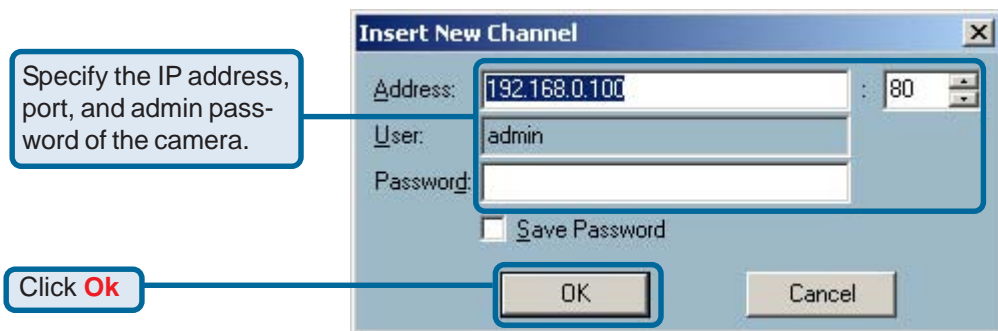

Once added, you will see the IP address of the camera and also the port that is opened on the camera (port 80 in this example).

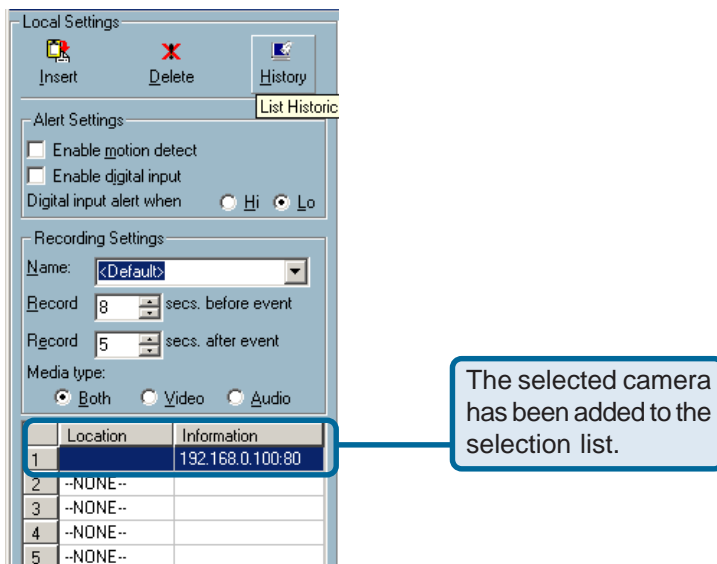

Using IP surveillance Software (continued)

Monitor Program (continued)

Delete – The deletion of a device is a much easier operation than “insertion”. It removes the selected network camera from the camera list. Highlight the camera that you want to delete from the list and click on the “Delete” button.

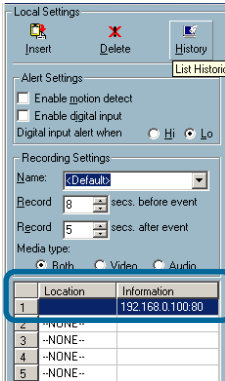

The selected camera will be deleted.

History – Clicking the “History” button will popup a historical camera list, which lists the latest 16 cameras you inserted into the camera list. 16 is the default number; you can change the number of the latest installed cameras you want to keep in the registry. Clicking on one camera in the history list will insert the camera into the camera list. The historical camera list is shown below.

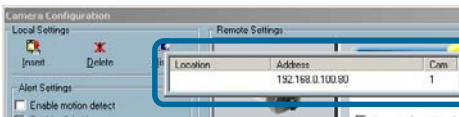

Historical camera list

Alert and Recording Settings

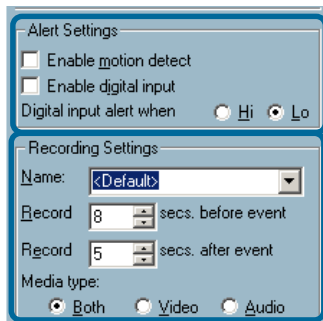

Alert Settings

Recording Settings

Using IP surveillance Software (continued)

Monitor Program (continued)

Alert Settings:

Specific alert actions can be performed by setting the options in this window.

- **Enable motion detect**
This will trigger an alert sound that has been specified in the section titled “Global Settings \ Alert Sound.” Check this option to enable audio alerts for the selected camera.
- **Enable digital input**
This function is similar to “Enable Motion Detect” mentioned above. Once this option has been checked, a digital input device will be able to trigger an alert sound and recording.
- **Digital input alert**
This application software provides options for you to define the triggering criteria for the digital input of the **DCS-3220G**. The alert of the digital input can be defined as high-level triggered or low-level triggered.

Recording Settings:

- **Record # secs. before event**
Once the automatic video recording has been activated, you can change this setting to regulate the recording of triggered events. Recording will start from the specified number of seconds before the alert event has been invoked.
- **Record # secs. after event**
Recording will last for the specified number of seconds after the alert event has been invoked.
- **Media Type**
You can specify which media type you want to record: Video, Audio, or both.

Using IP surveillance Software (continued)

Monitor Program (continued)

Changing the Camera Order in the List

You can “drag and drop” in the grid area of the camera list to change the sequence of the connected Network Cameras, which is shown below. This will allow you to rearrange the cameras in an order of your choice. Once the camera is moved to a specified location, the proceeding cameras will then move 1 position up or 1 position down depending on which direction the selected camera was moved.

Step 1:

	Location	Information
1	Front Door	192.168.0.100:80
2	--NONE--	
3	--NONE--	
4	--NONE--	
5	--NONE--	
6	--NONE--	
7	--NONE--	
8	--NONE--	
9	--NONE--	
10	--NONE--	
11	--NONE--	
12	--NONE--	
13	--NONE--	
14	--NONE--	
15	--NONE--	
16	--NONE--	

Press the left mouse button at the gray index field.

Step 2:

	Location	Information
1	--NONE--	
2	--NONE--	
3	--NONE--	
4	--NONE--	
5	--NONE--	
6	--NONE--	
7	--NONE--	
8	--NONE--	
9	--NONE--	
10	--NONE--	
11	--NONE--	
12	Moving channel 12 ...	2.168.0.100:80
13	--NONE--	
14	--NONE--	
15	--NONE--	
16	--NONE--	

Move the mouse to your new selected location and release the mouse button. Then Video 1 will be moved (to the 12th row in this example).

Once you click the “Save” button in the left-bottom corner of this window, the changes for all camera configurations will be saved and will be applied immediately to the IP surveillance.

Using IP surveillance Software (continued)

Monitor Program (continued)

Global Settings

After completing the connection to each remote Network Camera, we need to configure some global settings for all the cameras. These include the video database directory, the usage of the Hard disk, and options for video display.

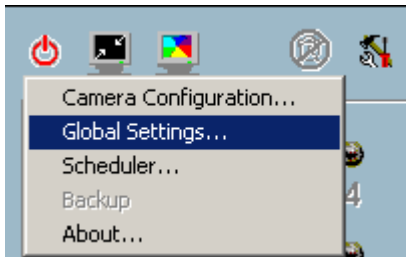

You can activate the global settings window from “Configuration Menu > Global Settings...” shown above.

All recording processes will be stopped when activating the global settings window, indicated by a warning window popped up in advance to keep you informed.

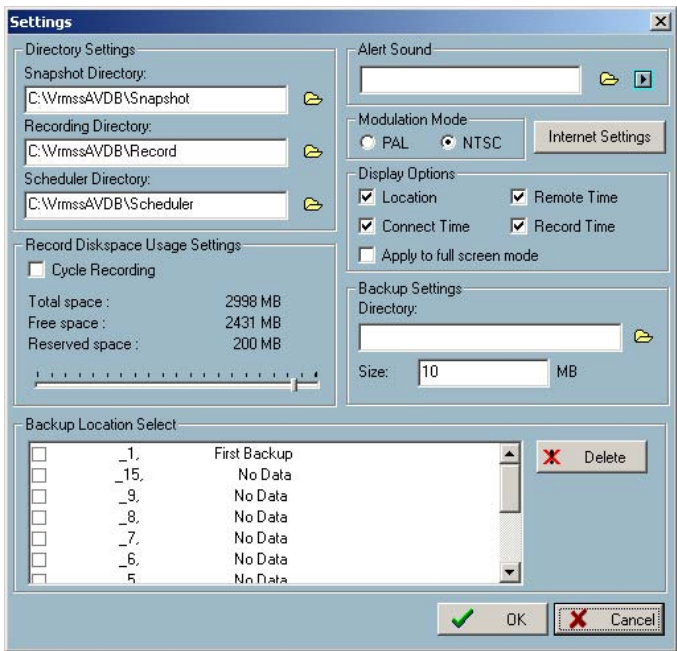

Using IP surveillance Software (continued)

Monitor Program (continued)

Directory Settings:

- **Snapshot directory**

The directory for storing snapshots in *.bmp format from video channels of the monitor tool and playback programs, which is shown on page 82.

- **Recording directory**

The directory for storing the recorded video data from video channels.

- **Scheduler directory**

The directory for storing the default and user-customized schedules for the scheduled recording of each channel.

Record Diskspace Usage Settings:

- **Cycle Recording**

When you turn this setting on, the video database system of this application software will overwrite the oldest data if the specified path has become full. That means it will record video data in a loop. If this setting is unchecked, a warning message will pop up when it is approaching the storage space limit. All recording will stop when the limit of the hard disk usage is reached.

- **Reserved space**

Indicate the size of the hard disk that will be reserved for other Windows applications (at least 15%). The remainder of the hard disk space will be available for recording. The more space you have reserved, the less there will be available for your camera(s) to record to. As you move the bar to the right, more space will be available for your camera(s) and conversely, less space will be available for your other applications. If the recording data exceeds this limitation, the new video data will replace the oldest data (on a First In First Out (FIFO) basis) when “Cycle Recording” has been checked.

- **Alert Sound**

You can load a custom *.wav file for the sound of alert triggering. You can also select from the sound files in Windows.

Using IP surveillance Software (continued)

Monitor Program (continued)

- **Modulation Mode**

You must select the input signal format (NTSC or PAL) for displaying the original resolution of video stream from **DCS-3220G**.

NOTE: You need to select the input signal format according to the camera type or CCD module type that is connected to the **DCS-3220G**.

Display Options:

In the video displaying frame of each channel, there are two status bars. The upper bar contains “Camera location” and “time of the remote site.” The lower bar contains “Connection time” and “Recording time.” All of them, shown in the figure below, can be enabled or disabled here individually for the status indication. Apply to full screen mode can also be turned on here. Once it has been checked, the status bar in each channel showing date, location, connection, and recording time will be shown in both display frame mode and full screen mode.

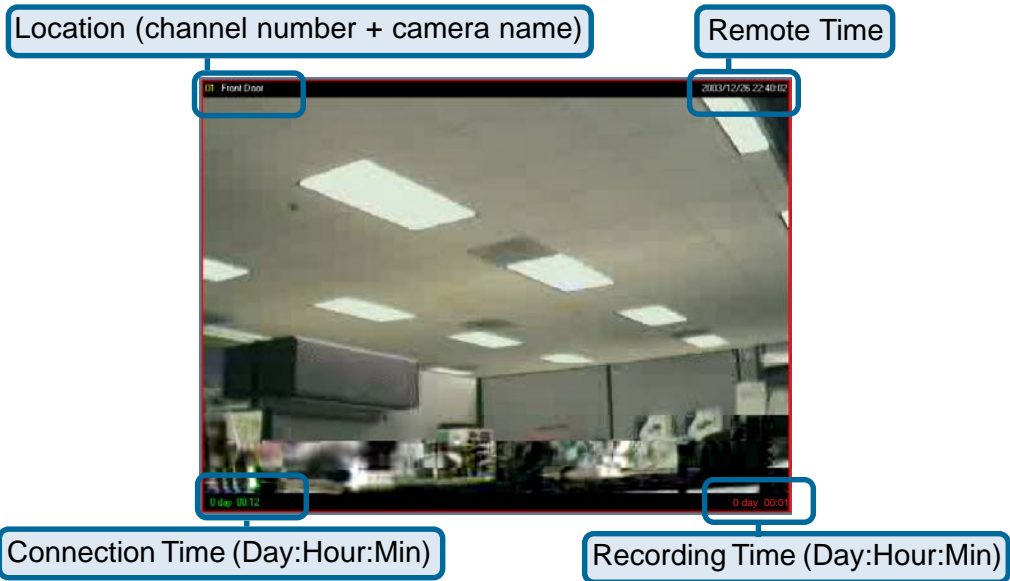

Using IP surveillance Software (continued)

Monitor Program (continued)

Backup Settings:

Using Backup Settings in the global settings window, you can backup recorded data from selected cameras to a specified location.

- **Directory**
This is the directory where backup data will be saved. You can select the location by clicking on the folder icon.
- **Size**
You can set the size limit of the data that will be backed up. The default size limit is 10MB. The maximum value for this setting depends on the amount of Free Space available on your hard drive. This value can be found under the “Record Disk space Usage Settings” section of the global settings window.
- **Backup Location Select**
Select the locations to backup by clicking the checkbox next to the location/camera name. To delete a location, select the location and click the “Delete” button to the right of the Backup Location Select window.

After you have set your backup settings in the global settings window, you can backup recorded data by clicking “Backup” in the Configuration Menu, as seen below:

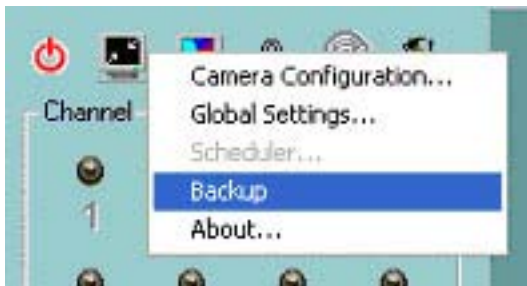

Using IP surveillance Software (continued)

Monitor Program (continued)

Using the Monitor Program

This section depicts, in detail, how to manipulate the monitor tool.

Connection of the DCS-3220G

Channel:

Once you have the privilege to connect to the **DCS-3220G**, the cameras will automatically appear in the video area in the order they are connected. Once you have set up the camera in the video channel, the color of the channel number will turn blue, indicating that the camera has been added to IP surveillance. If you do not set up the camera for the video channel, the color of the channel number will be gray.

There is a unique light signal associated with each channel number. It indicates the status of the dedicated video channel, which is depicted as follows:

- **Off**
The video channel is not connected with any **DCS-3220G** yet.
- **Green**
The green light means the **DCS-3220G** associated with this channel number is connected, and the video is monitored in the video area.
- **Red**
The red light indicates the video from this channel is recording into the video database. In this mode, you don't have to drag and drop the channel to the video area. This means that this application software supports real-time recording with and without real-time monitoring for the dedicated video channel.
- **Blink**
With the motion detection mechanism set in the **DCS-3220G**, the light of the corresponding channel will blink once the motion event is triggered.

Using IP surveillance Software (continued)

Monitor Program (continued)

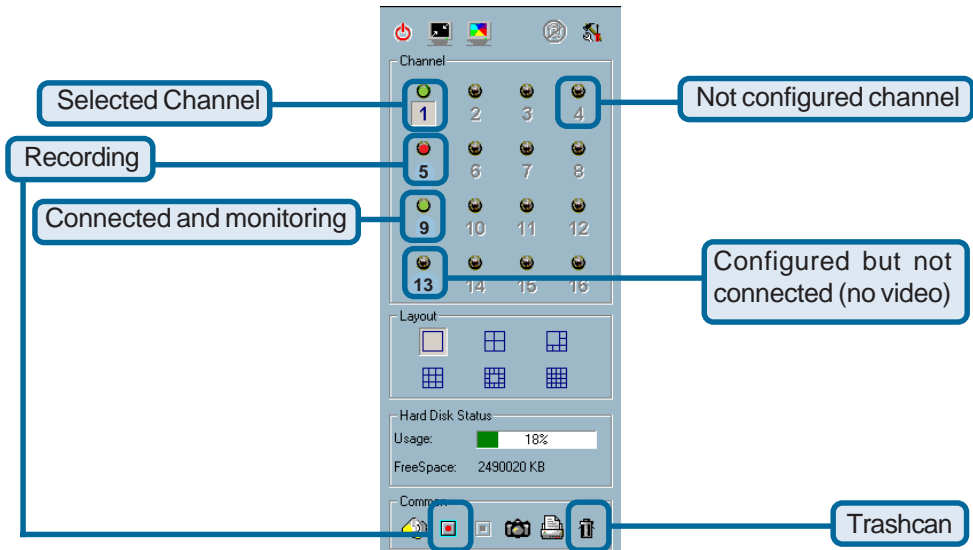

If you do not want to monitor one video, you can drag and drop the video (in the video area) to the trashcan in the common control area of the monitor program. The following section will demonstrate the procedures for “drag and drop” step-by-step.

Show the video of a specified channel

This section depicts the method of how to show the video of a specific channel in a display window.

Step 1: Move the mouse cursor to the display window shown below.



Using IP surveillance Software (continued)

Monitor Program (continued)

Step 2: Press and hold the left mouse button, and then move the cursor to a displaying window in the video area, which is shown below. Note that the cursor will change according to the area in order to indicate whether the area is droppable or not.

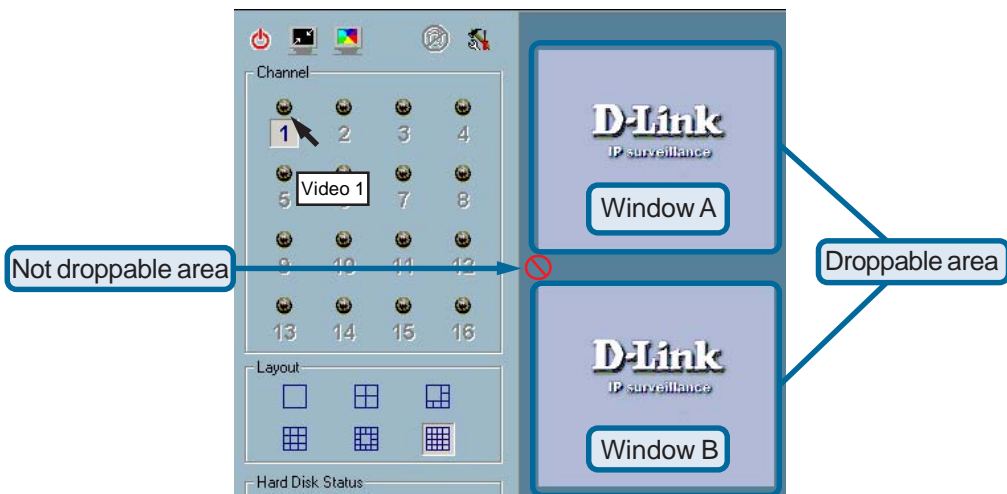

Step 3: Release the left mouse button while on top of a display window. In each display layout, only one window can be assigned to a camera. Also, each camera must have its own separate window when displayed. Once the video is in a display window, it can be dragged and dropped to other windows. If you drag one camera's video to a window that already has its own camera's video, the two cameras will trade display windows. Dragging and dropping is a very convenient way to manipulate the video channels in the IP surveillance Software.

Using IP surveillance Software (continued)

Monitor Program (continued)



Removing video from a display window

Step 1: Move the mouse cursor to the display window that contains the video channel you wish to remove.

Step 2: Note that the cursor will change to the hand-shape when it has been moved onto the displaying frame. After that, press the left mouse button and hold it.

Step 3: Move the cursor, while still holding the left mouse button, to the trashcan in the common area of the monitor program.

Step 4: When the cursor shape changes to an arrow-shape over the trashcan, release the left mouse button. The video in the corresponding display window will disappear. All operations above are shown in the figure on the following page.

Using IP surveillance Software (continued)

Monitor Program (continued)

Press and hold the left mouse button here.

Move the mouse cursor here, and then release the left mouse button.

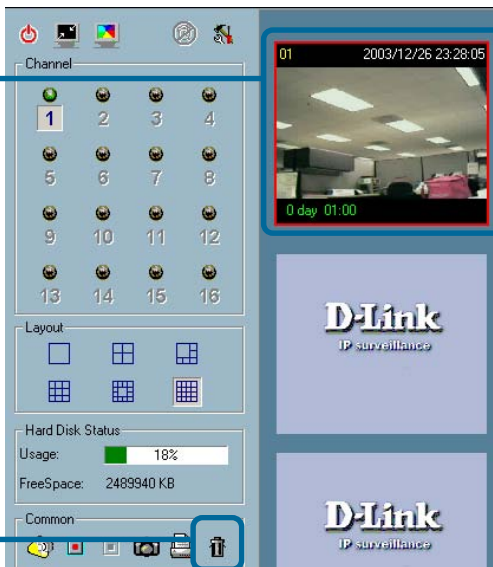

The Layout

There are six different layouts available, as shown below, for the display windows in the monitor program. You can select one of them by clicking on a layout icon. In each layout, you can drag and drop the “channel number” to any display window in the video area. Following the procedures described in the section titled “Show the video of a specified channel”, you can add the video channels to display windows within the selected layout in the video area one by one. You can also exchange the video between different display windows by dragging and dropping.

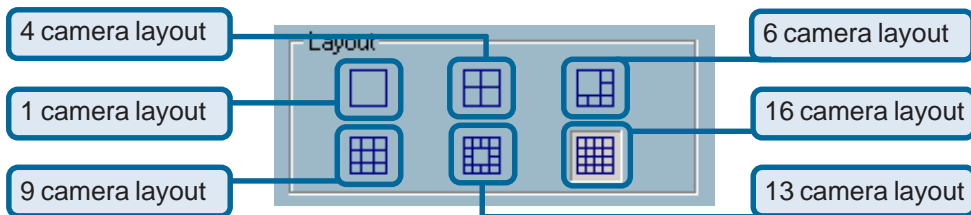

Using IP surveillance Software (continued)

Monitor Program (continued)

Double click on a display window to switch to a single channel layout.

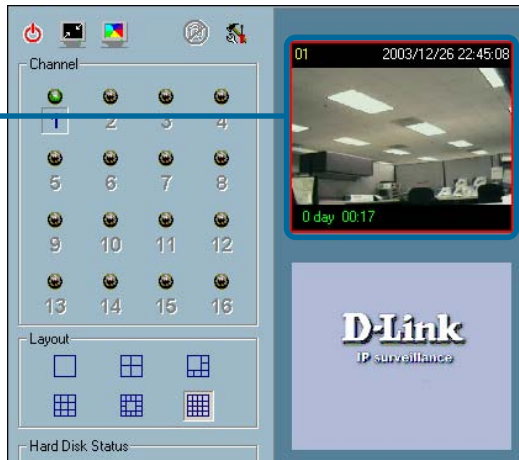

When you choose the one-channel layout or four-channel layout, the “Page up” and “Page down” buttons will be shown in the left-bottom corner of the video area. You can use these two buttons to switch the pages, as shown in the figure below.

Use to switch between cameras.

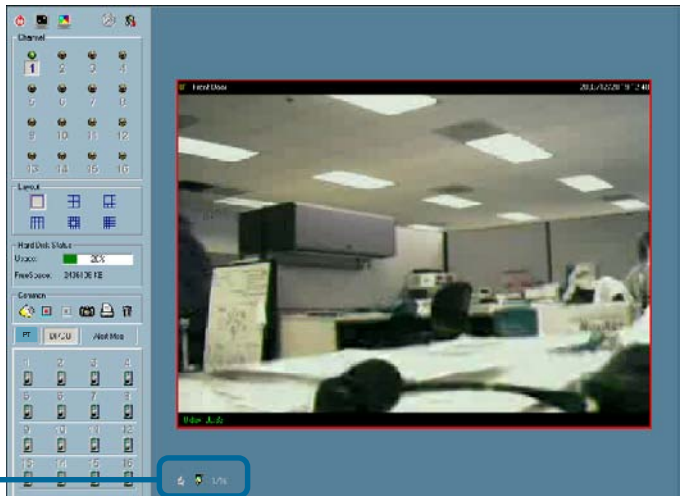

Using IP surveillance Software (continued)

Monitor Program (continued)

To view an individual camera from the multi-camera layout, double-click on the desired display window. You will see that the size of the display window is the same as the one-channel layout. Clicking the “Back” button in the upper-left corner of the video area will switch to the previous selected multi-camera layout.

The position that each video channel is in for every layout will be saved for the next time the layout is selected.

Back to previous layout.

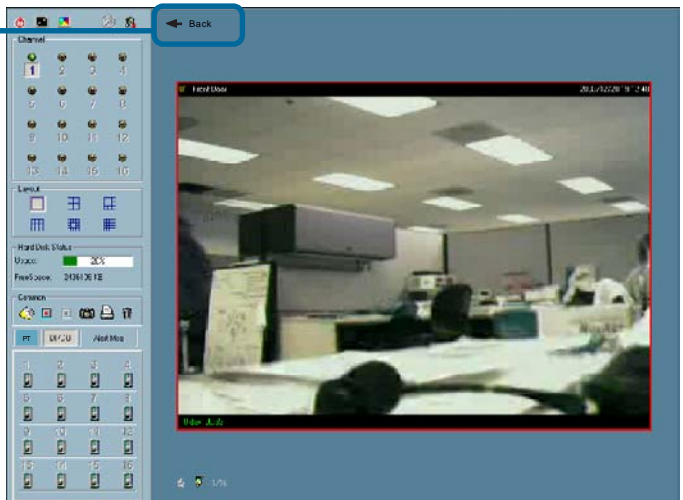

Input/Output Control Tools

Digital Input / Digital Output



Alert Message

Using IP surveillance Software (continued)

Monitor Program (continued)

IP surveillance includes DI/DO control (Digital Input / Digital Output) control and an alert message receiver. Each of these are described in detail below.

DI/DO Control

Clicking on the “DI/DO” button shown below, you can switch to the DI/DO controls. The color of the channel number indicates the status of the camera’s DI (Digital Input). You can click the “Switch button” to change the HI/LOW state of the DO (Digital Output). With these features, you can monitor the remote sensor input from DI and also trigger the camera by DO switch.

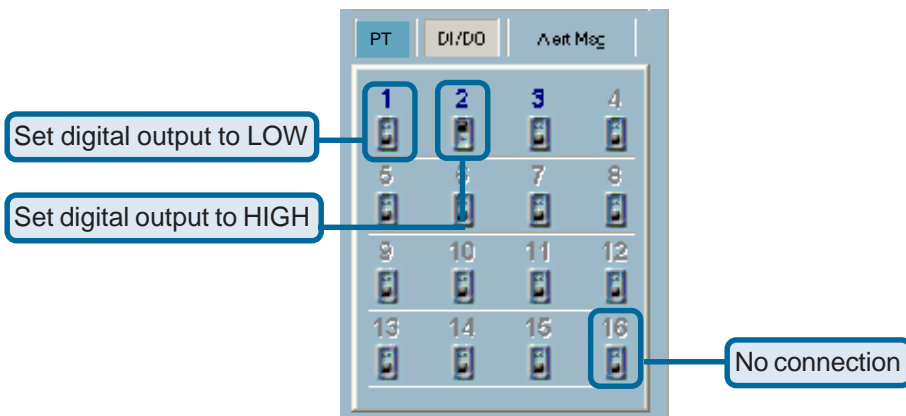

When the color of a DI/DO channel number is gray, that means the video channel has not yet been connected to a camera.

Using IP surveillance Software (continued)

Monitor Program (continued)

Alert Message

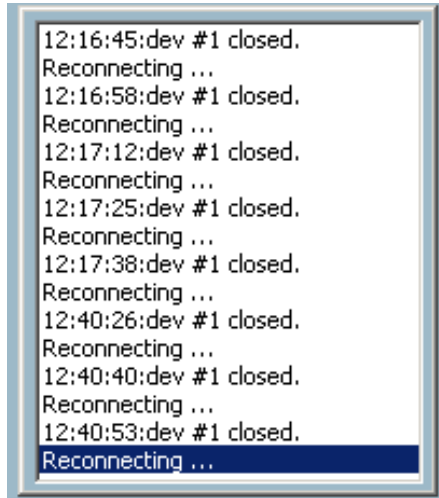

If you have checked the box “Enable Motion Detect” or “Enable Digital Input” on the Camera Configurations > Alert Settings screen, the alert message will show in the window shown above. Once the alert, caused by motion detection or a digital input level change is triggered, the alert message will be shown in this window. If there are more events than this window can display, a scroll bar will appear.

The message format is described as follows:

“time”=>”alert type” #”channel number”(“win1”, ”win2”, ”win3”)

For example, the message “PM 02:41:00=>MO #1(0,1,1)” means that this is a motion detection alert occurring at 02:41:00 PM in Motion Window 2 and Motion Window 3, for camera #1. If the message “PM 02:41:56=>DI #1” is listed, that means there is an alert triggered by the DI, for camera #1, at 02:41:56 PM .

Using IP surveillance Software (continued)

Monitor Program (continued)

About

By choosing “About”, located in the configuration menu shown below, a dialog box will appear and display the information about the installed version of IP surveillance. The information includes the software name, version, user name, and company.

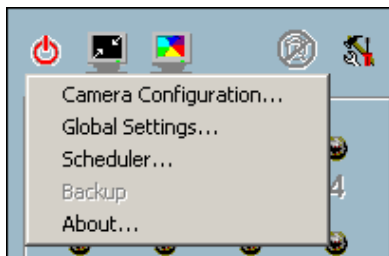

Miscellaneous Functions

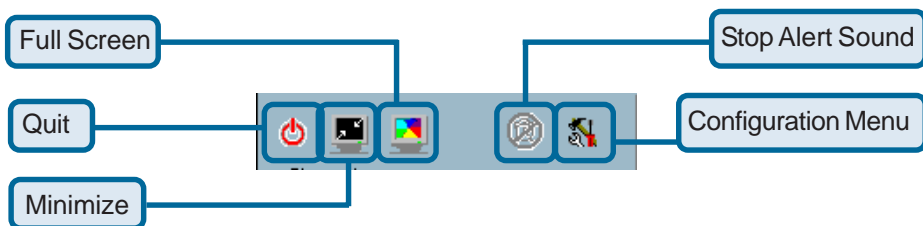

This section will describe some other miscellaneous functions of the icons shown above. These functions are:



Quit

By clicking this button, IP surveillance will be closed with the latest settings saved.



Minimize

Minimize the Monitor program.

Using IP surveillance Software (continued)

Monitor Program (continued)



Full Screen

With this function, you can enlarge the selected video channel to a full-screen display. Press the “ESC” key on the keyboard or double click the mouse on the screen to return to a regular display.



Stop Alert Sound

If an alert is triggered, the alert sound will start to play. After being informed of the situation, you can press this button to stop the alert sound. It will also switch the I/O Control to the Alert Message receiver, so that the alert messages can be reviewed.



Configuration Menu

The menu includes Camera Configuration, Global Settings, Scheduler, and About options.

Common Control Functions

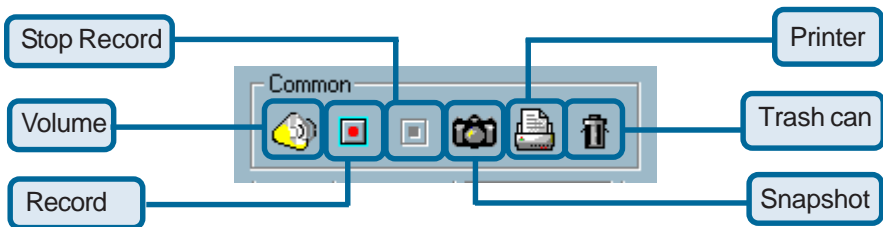

This section will describe the common control functions, shown above, which are depicted by the small icons. These functions only apply to the currently selected channel. These functions are:



Volume Control

Click on this button to adjust your volume settings.

Using IP surveillance Software (continued)

Monitor Program (continued)



Record

By clicking on this button, you can manually record video from the selected channel.



Stop

After video recording has been activated, this button allows you to manually stop recording the selected video channel.



Snapshot

This button will take a snapshot of the selected video channel and then save the picture as a bitmap file to the hard disk. You can set the directory for storing these bitmap files at the "Configuration menu > Global Settings screen". Please refer to the section titled "Global Settings" for more details.



Printer

Click on the printer icon to print the current image to your default printer.



Trashcan

You can drag and drop the video channel to the Trashcan to close the video connection with the **DCS-3220G**.

Status Bar

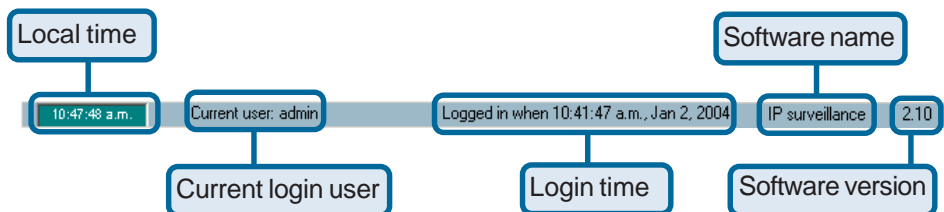

Using IP surveillance Software (continued)

Scheduling

The scheduler allows the user to schedule recordings from the selected video channel of the **DCS-3220G**. Through both the graphic user interface and time period selection options, you will be able to easily regulate a schedule for each video channel.

The main features of the scheduling tool are:

- Friendly graphic user interface for schedule editing
- Flexible schedule scheme suitable for all applications
- Individual schedule for each video channel
- Supports up to 9 preset schedule schemes for each video channel
- Automatic period recording

Using the Scheduler

This section discusses the method of how to use the scheduler.

Start the Scheduler

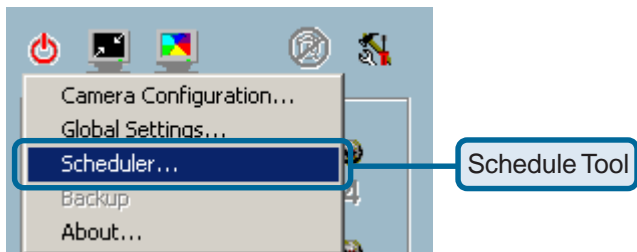

Using IP surveillance Software (continued)

Scheduling (continued)

The scheduler will not be accessible until at least one camera has been added to the camera list. Go to the configuration menu and click on “Scheduler” to launch the Scheduler.

The Layout and Functionalities

Introduction

The layout of the scheduler and its components, shown below, will be described.

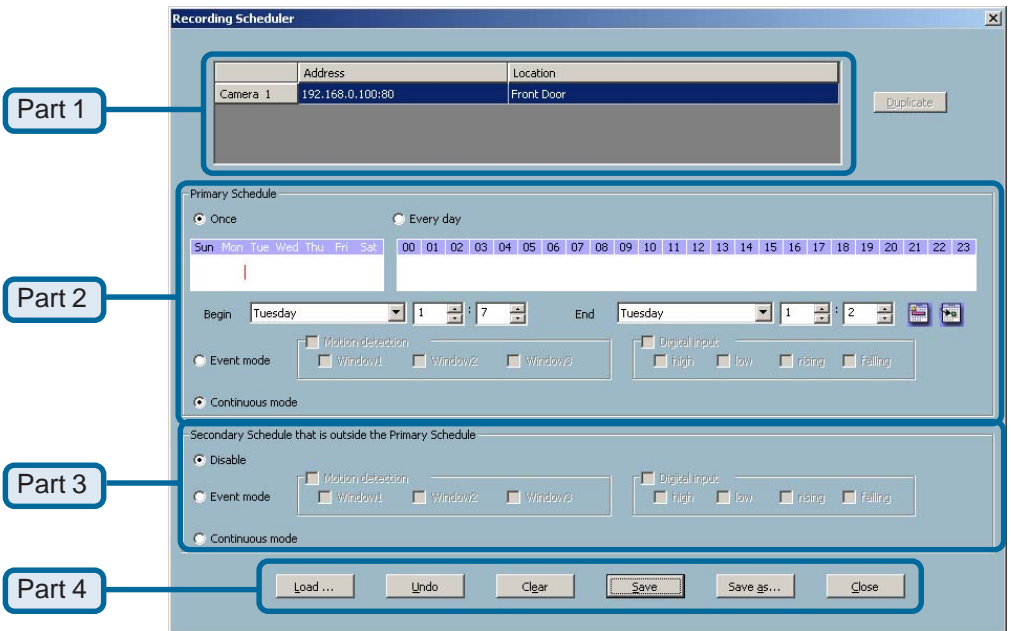

Using IP surveillance Software (continued)

Scheduling (continued)

The layout of the scheduler is roughly divided into 4 parts:

- **Part 1**
The first part of the scheduler is the video channel selection area. It provides the IP addresses and location information of the connected video channels for the user's reference. You can select a video channel in this area and create a schedule for it.
- **Part 2**
The second part is the Primary schedule settings. It consists of the **day time-line**, **week time-line**, **begin time selector**, **end time selector**, and event mode settings.
- **Part 3**
The third part is the Secondary schedule, which consists of event mode settings.
- **Part 4**
The fourth part contains **the operation buttons** for the user to manipulate the edited schedule of the selected video channel. The scheduler can be closed from here.

The Functionalities of Configuration Components

The four main parts of the scheduler have been briefly described in the section above. Parts 1-4 will be described in detail in the following section.

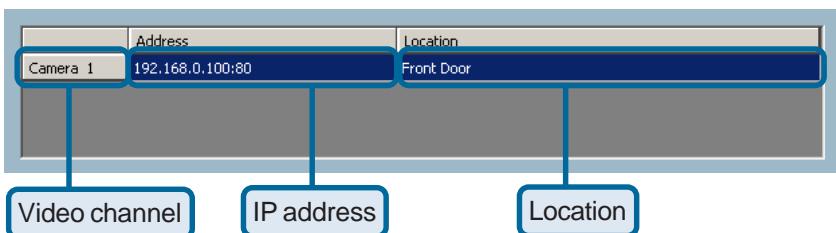

Using IP surveillance Software (continued)

Scheduling (continued)

In this area you will select the video channel that you want to set a schedule for. Each video channel will display a name, IP address, and location. Please note that when you switch between video channels in this area, the changes in the schedule of the previous video channel will be saved automatically.

Primary Schedule

Schedule with Time Lines

There are two different time-lines: hour unit time-line and week unit time-line. You can make your own schedule by plotting markers in all time-lines. These two time lines are associated with each other. That is, if you make changes in one time-line, the corresponding changes will be applied with scale to the other three time-lines in the same schedule. Before you begin, make sure that you select “Once” (page 99) if you want to choose the days to record on.

Week Time-Line

In the figure below, Week time-line is displayed. It includes the time-line, schedule information, and the selected day in the week.

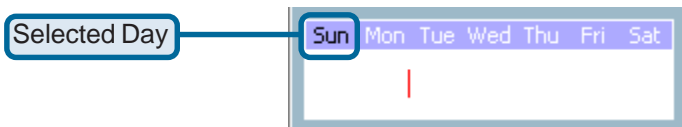

Marking/Unmarking the Recording Time on the Week Time-Line

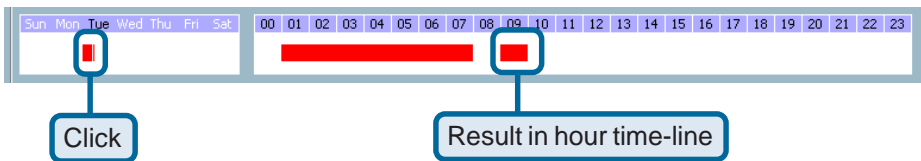

The corresponding changes for the markers on the week time-line will be automatically added to the hour time-lines, which is shown above. You can also mark and unmark the plotted bar by clicking and dragging with the left and the right mouse button.

Using IP surveillance Software (continued)

Scheduling (continued)

Hour Time-Line

In the figure below, the Hour time-line is displayed.

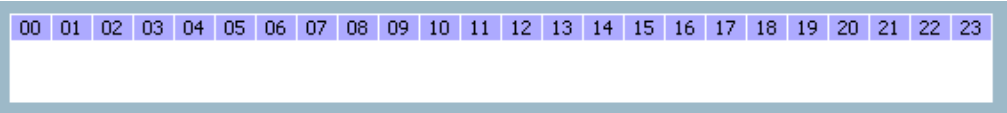

Marking/Unmarking the Recording Time on the Hour Time-Line

You can apply the one-click function by clicking the left mouse button and dragging to mark the time on this time-line. The operating method for the hour time-line is the same as that of the week time-lines. Please refer to the previous section about marking/unmarking on the week time-line for more details.

Schedule with Time Picker

Begin and End Time

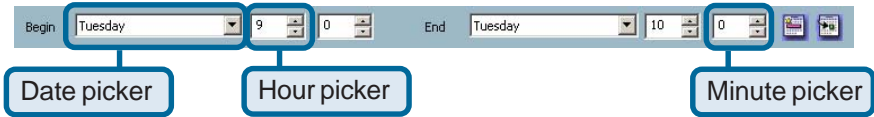

There are three controlling units in both “Begin Time” and “End Time” selectors shown above. The first unit of these two selectors is the date picker. You can select day with it to set the beginning time and the ending time for the recording interval.

The second and third units are the hour picker and the minute picker. You can change the hour and minute settings for the beginning and ending time with them.

NOTE: The time set in “Begin time” must be earlier than that in “End time”. Otherwise the settings will not be applied.

Using IP surveillance Software (continued)

Scheduling (continued)

Apply and Erase Buttons

After you have selected the time period with “Begin time” and “End time” picker, you can apply the period picker, shown in the figure below, to set the periodical types of the time interval set previously. After the settings in “Begin Time”, “End Time” and “Period Picker” are all done, you should click the “Apply” button or “Erase” button to add or clear this scheduling information to the editing schedule scheme. Note that only after you click on the “Apply” button, the scheduling information settings will be written back into the whole editing schedule scheme. That means this edited scheduling time interval is valid only after you “Apply” the changes.



Schedule in event mode

You can select to record in Event mode or Continuous mode by the Schedule mode selector as shown in the figure below. There are two types of event recording. Please refer to the following two sections for more information.

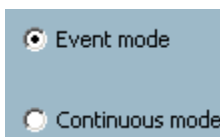

Motion Detection



As shown above, you can check the windows that you would like to record while the motion detection is triggered.

Using IP surveillance Software (continued)

Scheduling (continued)

Digital Input



In the figure above, there are four conditions for the digital input. Check the condition that you would like to record while the condition triggers.

- **high**
Checking this will trigger recording while the digital input is high. The technical name for this event is line trigger.

- **low**
Checking this will trigger recording while the digital input is low. The technical name for this event is line trigger.

- **rising**
Checking this will trigger recording while the digital input is changing from low to high. The technical name for this event is edge trigger.

- **falling**
Checking this will trigger recording while the digital input is changing from high to low. The technical name for this event is edge trigger.

Schedule in Continuous mode

If you select Continuous mode in the schedule mode selector, it will record continuously during the schedule that is set up by the user.

Secondary Schedule

Secondary schedule is the time that is outside the primary schedule.

Schedule modes

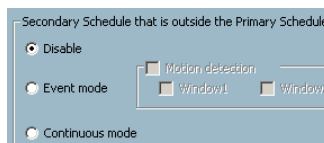

Using IP surveillance Software (continued)

Scheduling (continued)

There are three modes in the secondary schedule: Disable, Event mode, and Continuous mode. You can either disable the secondary schedule or choose the event or continuous mode. These two modes are the same as the primary schedule. Please refer to the previous section for more detail.

The Schedule Scheme operations

There are six related buttons. “Load...”, “Undo”, “Clear”, “Save”, “Save as...” and “Close” for handling the schedule schemes. These operations are shown in the figure below.



- **Load...**
This button allows you to load pre-edited schedules from the scheduling directory for the selected video channel. Note that you should save the schedule you are currently working on before loading a new one. Otherwise, the current changes will be lost.
- **Clear**
This button will clear all changes in the current schedule of the selected video channel.
- **Save**
This button is used for saving changes to the current schedule.
- **Save As...**
This button is used to save the current schedule as another file name instead of the default name.
- **Undo**
Click on this button to undo all changes for the current schedule since the last save.
- **Close**
Click on this button to close the scheduler.

Using IP surveillance Software (continued)

Playback Program

The playback program is a very powerful, convenient, and easy way to browse the recorded video. It has one display mode (normal display mode) and two playback methods (full range and time period). There are several main functions including special features in the Playback program. These functions are depicted as follows.

Features of Playback

Powerful play control tool:

- Play
- Stop
- Pause
- Step forward
- Fast play (from x1 to x16)
- Slow play (from /1 to /16)

Convenient display adjustment tool:

- Zoom in (from 1:1 to 2.25:1)
- Zoom out (from 1:1 to 1:2)
- Full screen

Flexible searching range adjustment tool:

- User input (from full range to 1 second)
- Zoom in (from full range to 10 seconds)
- Zoom out (up to full range)
- Full range

System control tool:

- Window locker
- System settings

Using IP surveillance Software (continued)

Playback Program (continued)

Logging In

Before you start the playback program, it is necessary for you to log in to the application software. The figure below shows the login dialog. For security concerns, only the admin account can log in to this program. To change the password of the admin account, please refer to the section titled “Logging In.”

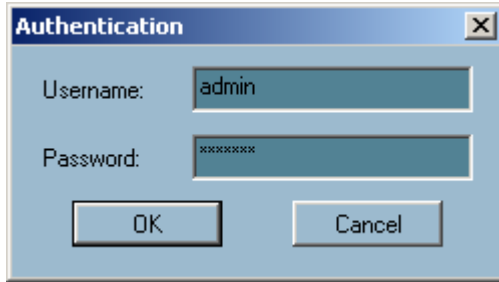

Layout

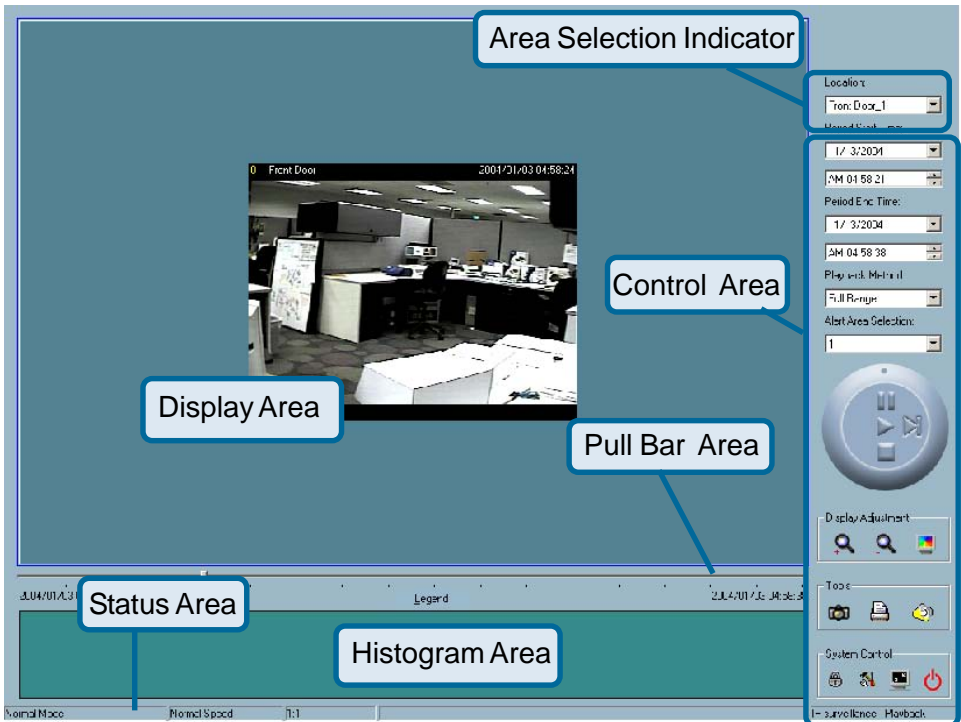

Using IP surveillance Software (continued)

Playback Program (continued)

When you successfully log in to the playback system, the main window will be shown on the top of the screen and the display resolution will be changed to 1024x768 automatically (see page 107). There are four main areas, i.e. display area, histogram area, control area, and status area. There are also three visualized controls , i.e. area selection indicator, frame selection indicator, and pull bar. These features provide much more convenience while searching recorded video in the IP surveillance database.

Main Areas

Display Area

The display area is able to show the surveillance database of each camera by time. You can change the video size through the display adjustment tool and the playback method through the play control tool. Under the normal display mode as shown in the figure below, you can just double click on the frame area to change the frame size to 1:1 or 2.25:1.

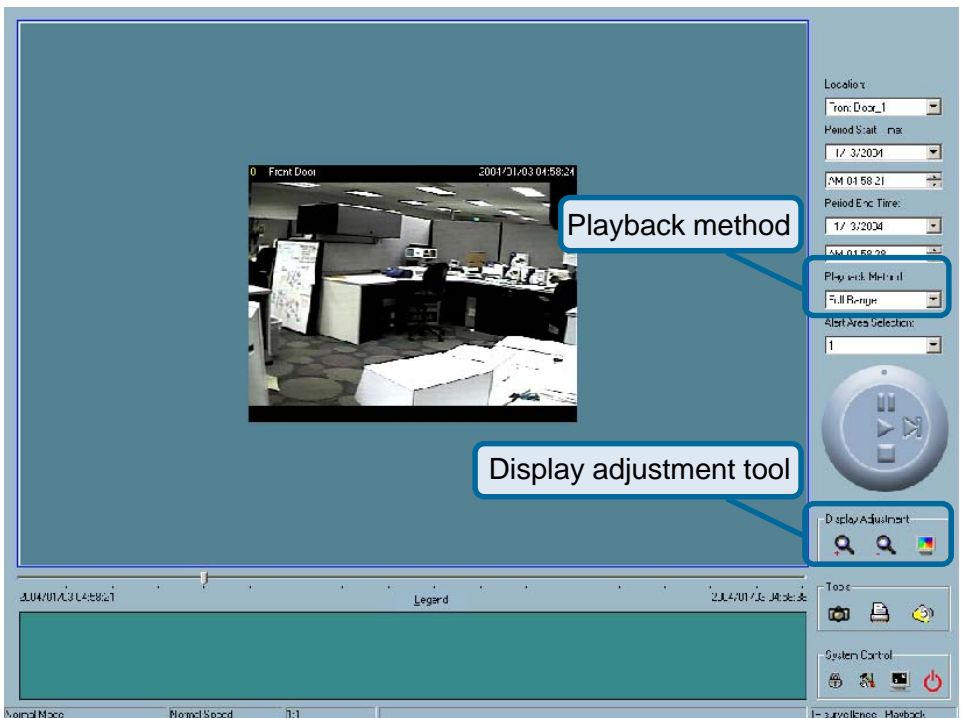

Using IP surveillance Software (continued)

Playback Program (continued)

Histogram Area

The histogram is an interactive control. Not only can you get the event's location in time domain and its quantity of the motion percentage, but you can also select a group of events or a period from the event histogram area and show it on the display area.

Control Area

The control area contains almost all the control selectors and toolboxes you need to browse the database. These control tools include location selector, period selector, playback method selector, jog dial, display adjustment tool, searching range adjustment tool, exporting tool, and system control tool.

Status Area

The status area is located at the bottom of the main window. It tells you the program status information including display mode, display size, display speed, exporting file format, and exporting file name.

Indicators

Area Selection Indicator

In the main playback window, the display area is surrounded by a blue rectangle. This rectangle is the area selection indicator. This indicator can be set to either display area or histogram area, as long as you move your mouse cursor to the area you intend to select. When you select the display area, the display adjustment tool will appear in the control area. If you select the histogram area, the display adjustment tool will disappear and the searching range adjustment tool will be shown in the same place of the control area.

Using IP surveillance Software (continued)

Pullback Program (continued)

Pull Bar

The pull bar is a fast, flexible control for seeking data in the selected time period. It represents the total length of time in that period. You can pull the indicator on the pull bar to the specific time-point you would like to view. The displaying video will halt and then restart, playing the video sequence from the point you selected. If the video sequence has been paused, the display area will show the point you selected without playing. Note that the pull bar will only function under the normal display mode.

Settings

After the main window is shown on the screen, you must modify the settings to make it to work properly. Click on the “Settings” button, shown below, in the system control tool, and the setting dialog will appear on the screen.

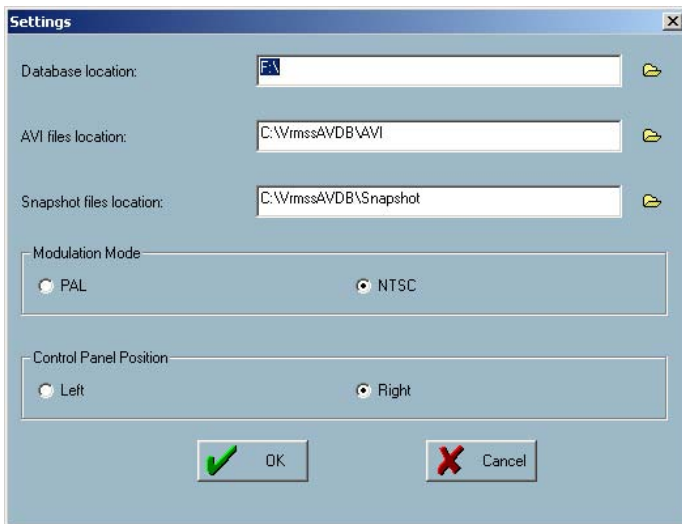
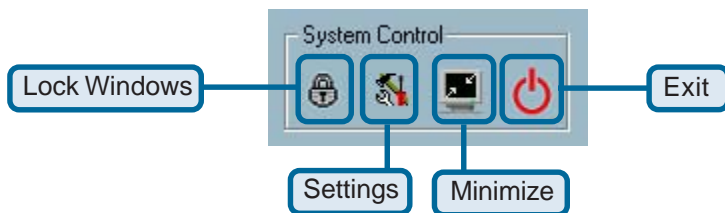

Using IP surveillance Software (continued)

Playback Program (continued)

The items in the settings windows are:

- **Database location**

The most important item in the settings dialog is the database location setting. You must set it to the directory that contains the surveillance database to make the program to work properly.

- **AVI file location**

This sets the directory where exported AVI files will be stored. Exported AVI files will be stored in the sub-directory (camera name) under the directory you set here.

- **Snapshot location**

This sets the directory where bitmap files will be stored when you use the snapshot to export them. Exporting bitmap files will be stored in the sub-directory (camera name) under the directory you set here.

- **Modulation Mode:**

The modulation mode cannot be changed. This depends on how you recorded the video sequence in the monitor program. If you select the wrong mode, the video shown in the display area will become distorted. If you have chosen the wrong modulation mode, you may open the settings dialog again, change to the correct mode, and restart the playback program. The display will now be normal.

Using IP surveillance Software (continued)

Playback Program (continued)

Normal (Single Frame) Mode

While in the normal (single frame) display mode, you can change the video currently displayed by:

- (1) Changing the database path for retrieving another one in the settings dialog of “System Control” tool.
- (2) Changing the location selector to another location in control area.
- (3) Changing the playback method selector to “Full Range.”
- (4) Changing the playback method selector to “Time Period.”

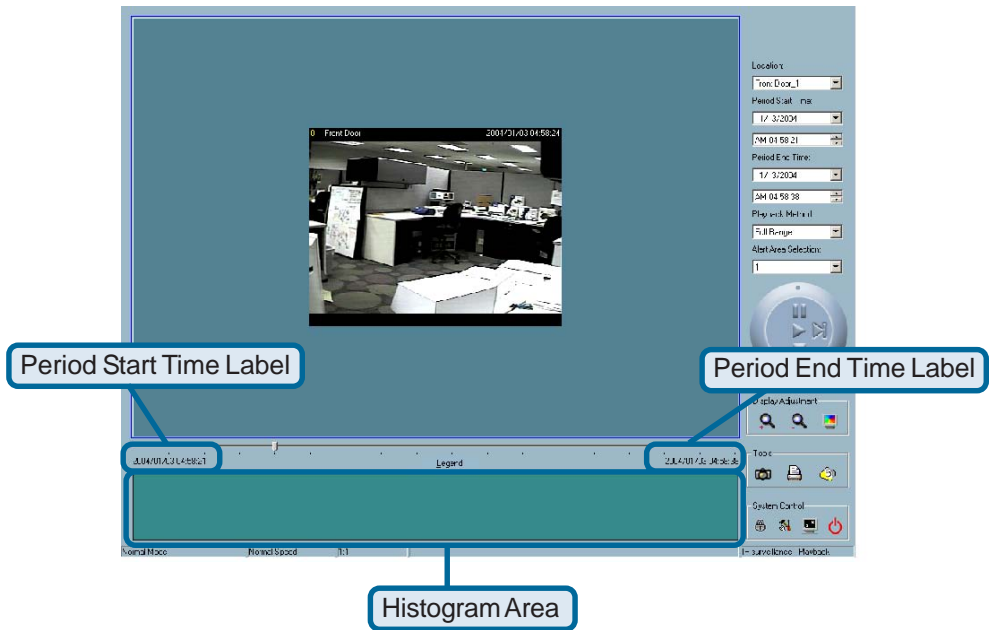

Under the normal display (single frame) mode, you can use all the tools provided with the playback program, except the page control. In this mode, the two labels under the pull bar show the starting and the ending time of the interval individually (as shown above).

Using IP surveillance Software (continued)

Playback Program (continued)

Histogram Area

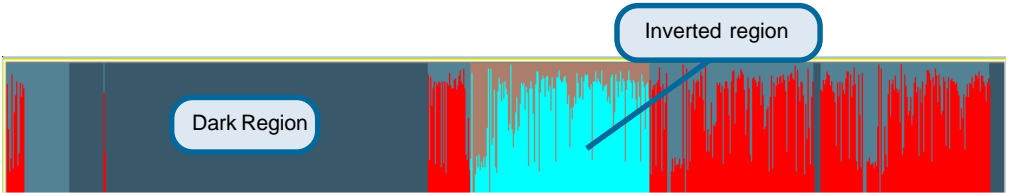

The histogram area in the normal display (single frame) mode only shows the events' occurred time and the percentage of motion detection with red bars. If you want to access the histogram area, you must change the area selection indicator to the histogram area. You can mark one time interval you want to see with a color-inverted region by dragging your mouse with the left button pressed (as shown above). When you release the left button, the color-inverted region will be enlarged to the whole histogram area. This color-inverted region will be the new period the program is going to display. If you change your mind and don't want to see that period, you can cancel it by just pressing the right button of your mouse with the left button still pressed. If you click on the left button without dragging it, the action will be the same as clicking on the pull bar in the same x-axis position. That means the playback system will shift to the pointed time and show video on the displaying frame. Besides, the dark regions in the histogram area mean there is no existing video data in that interval. If you click on those regions, nothing will happen except a warning message will pop up.

Using Tools

In this section, the method of how to use the tools in the control panel (shown in the main playback window) will be discussed.

Selector Tools

The figure below shows the selector tools. They are location selector, period selector for the selection of the beginning time and the ending time, playback method selector, and alert area selector.

Using IP surveillance Software (continued)

Playback Program (continued)

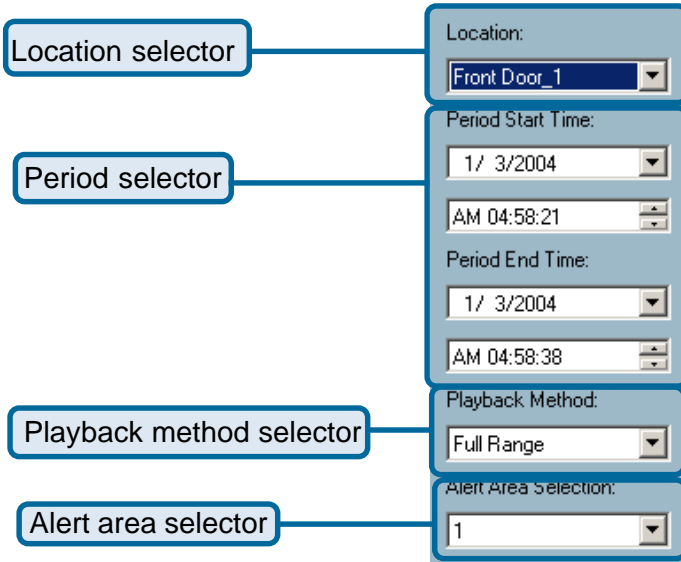

Location Selector

The location selector is a control that lets you select the camera you want to see (refer to the figure above). The location name is the same as the camera name (text on video) unless you have specified otherwise.

Period Selector

Period selector provides you a precise way to choose the start time and the end time of a new period. The end time must be later than the start time. After you provide the correct start and end time, clicking on the "Play" button in the jog dial will play the new period in the display area with changing the period start and end time label. Besides, the pull bar and histogram area will change, too. If the selected period is not present in the database, the data in the period selector will change to the previous correct start and end time, and a warning message will be displayed.

Using IP surveillance Software (continued)

Playback Program (continued)

Playback Method Selector

- **Full Range**

If you select this method, the database will be displayed from the beginning to the end of this location. Any change in the period selector will have no effect except when you change this selector to “Time Period.”

- **Time Period**

If you change the playback method to “Time Period”, you can modify the start and end time in the period selector. When you click on the “Play” button in the jog dial, the period you selected will be displayed.

Since the program will record the previous start and end time in “Time Period” and “Events Preview” mode, whenever you want to change the period selector to see the other periods, you must change the playback method selector to the mode you want to use first. Otherwise, the period selector will revert back to the previous period set the last time you changed the playback method selector.

Alert Area Selector

In the preview mode, the playback program can show the information of total events of only one alert window each time. If you want to see the events of the other two alert area windows, you must change the alert area selector to the other window numbers. In the normal display mode, the alert window that the alert area selector indicates will be highlighted with red rectangle if you checked that window in the settings dialog. The alert area selector will be changed to alert window 0 by default settings when you change the location selector to another window.

Play Control

For the play control, the jog dial, shown in the figure below, is used to provide the easiest method of controlling the video sequence display. All buttons can control the displaying frame in the normal display mode.

Using IP surveillance Software (continued)

Playback Program (continued)

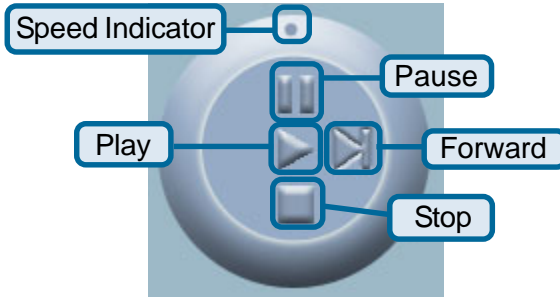

■ **Play**

The supported “Play” button is an intelligent play user-interface. The functionality of this button can vary to fit different circumstances. In the normal display mode, clicking on the “Play” button can restart the displaying video sequence.

■ **Stop**

When you want to stop the displaying video sequence, you can click on the “Stop” button. Note that once you press the “Stop” button, the start point will be reset to the start of the present period.

■ **Pause/Resume**

The “Pause” button provides you a way to pause the video sequence display. When the displaying video is paused, click on the “Pause” button again to resume the video display.

■ **Forward**

This button is only valid when the displaying video sequence is paused. It will display the next frame in that period when you click on the “Forward” button one time.

■ **Fast Play and Slow Play**

The camera supports a maximum of x16 fast forward play and minimum of /16 slow forward play. This function helps you browse the surveillance database with more flexibility. If you want to change the playing speed, you just need to move the speed indicator. To increase playing speed, move the indicator in the clockwise direction. And to decrease playing speed, move it in the counterclockwise direction. The current speed that is set will be shown in the second column of status area.

Using IP surveillance Software (continued)

Playback Program (continued)

Display Adjustment Tool

When you move the mouse cursor to the displaying area, the display adjustment toolbox will appear. Using the display adjustment toolbox, you can change the displaying video sequence to the size you want to see in the normal display mode when you move the area selection indicator to the display area. The figure below shows the display adjustment toolbox and its own three elements, i.e. “Zoom In”, “Zoom Out”, and “Full Screen.”



Zoom In

When you click on the “Zoom In” button one time, the image size in the display area will be magnified 12.5 percent to the original size. Due to the limitation of the display area size, the maximum zoom in ratio supported is only 2.25:1 for NTSC modulation mode and 1.875:1 for PAL modulation mode. If you want to see the image in more detail, you can use the full screen function that is supported in the same toolbox.



Zoom Out

When you click on the “Zoom Out” button one time, the image size in the display area will be minimized 12.5 percent to the original size. To show the location and time information completely, the minimum zoom out ratio is limited in 0.5:1.

Using IP surveillance Software (continued)

Playback Program (continued)



Full Screen

When you click on the “Full Screen” button, the video sequence will be enlarged to the whole screen instantly. You can double click on any place or the “ESC” key to return back to the normal screen. When you switch to the full screen display, you can press the “Alt” and “Space” keys together to pop the jog dial to control the displaying video sequence. Press the same keys again to close the jog dial. You can also press the “Alt” and “Enter” keys together to switch between the normal display and full screen display at any time when the program is under the normal display mode.

Searching Range Adjustment Toolbox

When you move the mouse cursor to the alert histogram area, the display adjustment toolbox will change to a range adjustment toolbox. The range adjustment toolbox provides a faster way to change the range of the displayed time period. By using this toolbox, you can browse the database of one location from any 10-second interval of the entire range. The figure below shows the searching range adjustment toolbox composed of its own three elements, i.e. “Zoom In”, “Zoom Out”, and “Full Range.”

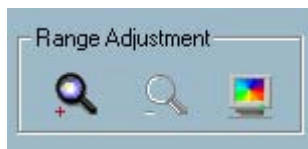

Zoom In

Each time you click on the “Zoom In” button in the searching range adjustment toolbox, the displayed time period will be half in the center of the original time period until the period is equal to 10 seconds. You can see the new interval in more details. The scale of pull bar and alert histogram window change. The period start and end time change as well. The period selector will show the new start and end time. The display area will restart and display the new period from the newly defined start time.

Using IP surveillance Software (continued)

Playback Program (continued)



Zoom Out

Each time you click on the “Zoom Out” button in the searching range adjustment toolbox, the displayed time period will be double in the center of the original time period unless the start time or end time exceeds the whole database time-boundary. The scale of the pull bar and alert histogram window change. The period start and end time change as well. The period selector will show the new start and end time. And the display area will restart and display the new period from the newly defined start time.



Full Range

When you click on the “Full Range” button, you will get the same functionality as when you change the playback method selector to “Full Range.”

System Control Toolbox

The system control toolbox provides some basic operations for the playback program. The figure below shows the three elements of the system control toolbox, i.e. “Lock Window”, “Settings”, “Minimize”, and “Exit.”

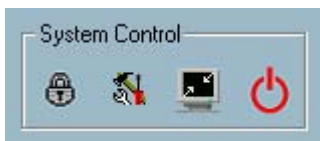

Lock Window

If you are away from your computer, for security reasons, we recommend that you to close the playback program or you can just click on the “Lock Window” button to lock the main window. Once you click this button, the main window will be hidden and the login dialog will appear. To return to the main window, you need to re-enter the admin’s password again.

Using IP surveillance Software (continued)

Playback Program (continued)



Settings

The settings dialog will pop up when you click the “Settings” button. For more information about setting this program, please refer to the section titled “Settings.”



Minimize

Click this button in order to minimize the playback program window.



Exit

The playback program will be closed immediately when you click on the “Exit” button.

Schedule Video Recording with Motion Detection

To schedule video recording with motion detection, you must first enable motion detection on the Internet Camera. Click the **Motion Detection** button under the **Advanced** tab from the **Configuration** screen to access settings that affect how the **DCS-3220G** Internet Camera can serve as a security device by recording only when motion is detected. Note: These settings can be configured in your Web browser and while logged into the **IP surveillance** Program.



Click **Motion Detection**

In this window, follow the steps below to ensure that motion detection is correctly enabled:

- ① Check “Enable motion detection.”
- ② Click on “New” to have a new window to monitor video.
- ③ Enter in a window name.
- ④ Adjust the “Sensitivity” and “Percentage” levels according to the local environment. The highest sensitivity and lowest percentage provides the most sensitive setting.
- ⑤ After adding the motion window, click on save to enable the activity display. You can add up to 3 motion windows to trigger recording.

For detailed information about each setting, please refer to **Configuration > Advanced > Motion Detection** in the section titled “Using the DCS-3220G With an Internet Browser” (page 50).

Next, run the **IP surveillance** program. Click on the **Configurations** button and select **Scheduler**.

Schedule Video Recording with Motion Detection (continued)

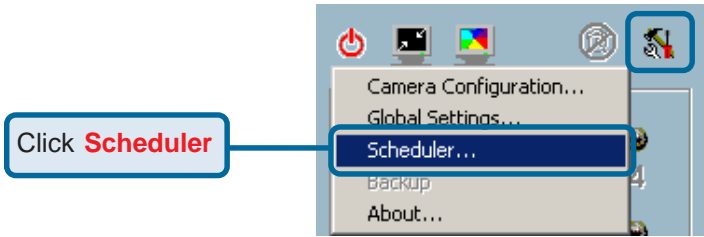

In the **Primary Schedule** you can choose either **Once** (for one time recording) or **Every Day** (for scheduled recording). For example, if you would like to record events every day during a certain time frame, click on the beginning time and drag your mouse to the ending time. Schedule recording can be configured by minutes, hours, days, weeks, or months.

The **Secondary Schedule** allows you to set a schedule outside the **Primary Schedule**. The **Secondary Schedule** provides two options to record without a specified date or time. You can select **Event Mode**, which will record whenever an event is triggered, or **Continuous Mode**, which will begin continuously after scheduling settings are saved. You do not need to set the **Secondary Schedule** with the **Primary Schedule**. To schedule video recording with motion detection, you can use either the **Primary Schedule** or **Secondary Schedule**, or both.

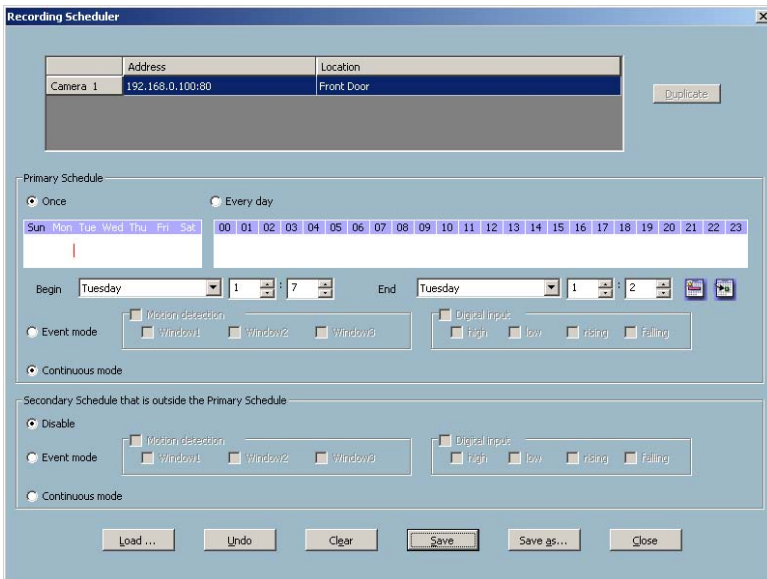

Schedule Video Recording with Motion Detection (continued)

In this window, follow the steps below to schedule video recording with motion detection in the **Primary Schedule**:

- ① Check if you want the recording schedule to occur **Once** or **Every day**.
- ② Set the date, time-line, and begin and end times for recording.
- ③ Check **Event Mode**.
- ④ Select the motion detection window that will be used to trigger motion detection. Note: You must first create motion detection windows in the Web configuration page of the camera. Remember the names of the windows and the order in which you created them, as they are not displayed inside the scheduler. Instead, they are listed in the order they were added. For example, the first window created is labeled "Window1."
- ⑤ Click on "Disable" under the **Secondary Schedule**.

Click the **Save** button when finished. You have now set a schedule to record video when motion detection is triggered. If you would like to save this configuration, click **Save As** to save this configuration to a folder in your hard drive. This configuration can be used on another system running IP surveillance or can be used as a backup if you need to re-install the IP surveillance software program.

Appendix

Frequently Asked Questions

Internet Camera Features

Q: What is an Internet Camera?

A: The Internet Camera is a stand-alone system connecting directly to an Ethernet or Fast Ethernet network. It differs from a conventional PC Camera, the Internet Camera is an all-in-one system with built-in CPU and Web-based solutions providing a low cost solution that can transmit high quality video images for monitoring. The Internet Camera can be managed remotely, accessed and controlled from any PC/Notebook over an Intranet or the Internet from a Web browser.

Q: What is the maximum number of users that can be allowed to access DCS-3220G simultaneously?

A: The maximum number of users that can log onto the Internet Camera at the same time is 10. Please keep in mind the overall performance of the transmission speed will slow down when many users are logged on.

Q: What algorithm is used to compress the digital image?

A: The Internet Camera utilizes MPEG-4 Simple Profile Mode image compression technology to provide high quality images.

Q: Can I capture still images from the Internet Camera?

A: Yes you are able to capture still images with the snapshot function from the software application CD supplied with the Internet Camera.

Internet Camera Installation

Q: Can the Internet Camera be used outdoors?

A: The Internet Camera is not weatherproof. It needs to be equipped with a weatherproof case to be used outdoors and it is not recommended.

Q: When physically connecting the Internet Camera to a network what network cabling is required?

A: The Internet Camera uses Category 5 UTP cable allowing 10 Base-T and 100 Base-T networking.

Frequently Asked Questions (continued)

Q: Can the Internet Camera be setup as a PC-cam on a computer?

A: No, the **DCS-3220G** Internet Camera is used only on an wireless 802.11g, Ethernet or Fast Ethernet network. The D-Link DSB-C110, DSB-C310 can be used as a PC Camera (Webcam).

Q: Can the DCS-3220G be connected to the network if it consists of only private IP addresses?

A: Yes, the Internet Camera can be connected to a LAN with private IP addresses.

Q: Can the DCS-3220G be installed and work if a firewall exists on the network?

A: If a firewall exists on the network, port 80 is open for ordinary data communication. The **DCS-3220G** uses port 5001 for control and synchronization, port 5002 for streaming audio and port 5003 for streaming video. These ports (or the ports you specify from the **Advanced > Network** Tab in the Configuration screen if you change the default ports) need to be opened on the firewall. See page 37 for detailed information.

Q: Why am I unable to access the DCS-3220G from a Web browser?

A1: If a router or firewall is used on the network, the correct ports for the **DCS-3220G** may not be configured on the router or firewall. To correct the problem, you need to determine if the **DCS-3220G** is behind a router or firewall and if the router or firewall is properly configured for the ports the **DCS-3220G** is using. Refer to Page 27 for help in opening the correct ports on a router or firewall for use with the **DCS-3220G**.

A2: Other possible problems might be due to the network cable. Try replacing your network cable. Test the network interface of the product by connecting a local computer to the unit, utilizing a Ethernet crossover cable. If the problem is not solved the Internet Camera might be faulty.

Q: Why does the Internet Camera work locally but not externally?

A1: This might be caused by network firewall protection. The firewall may need to have some settings changed in order for the Internet Camera to be accessible outside your local LAN. Check with the Network Administrator for your network.

A2: Make sure that the Internet Camera isn't conflicting with any Web server you may have running on your network.

A3: The default router setting might be a possible reason. Check that the configuration of the router settings allow the Internet Camera to be accessed outside your local LAN. See page 27 for detailed information.

Frequently Asked Questions (continued)

Q: I connected the Internet Camera directly to a computer with a cross-over cable Ethernet cable and received the following Windows error upon running IP Installer:



A1: This Windows error will occur if the Internet Camera is connected to a computer that is not properly configured with a valid IP address. Turn off DHCP from the Network Settings in Windows and configure the computer with a valid IP address or connect the camera to a router with DHCP enabled.

A2: This error can also occur if the **IP Installer** icon is clicked on more than once from the setup wizard.

Q: The focus on the Internet Camera is bad, how can I correct it?

A1: Adjust the Internet Camera focus manually as described in **Adjusting the Internet Camera Focus** in the Appendix section of this manual (page 133).

Q: Noisy images occur. How can I solve the problem?

A1: The video images might be noisy if the Internet Camera is used in a very low light environment. To solve this issue you need more lighting.

Q: The images appear to be of poor quality, how can I improve the image quality?

A1: Make sure that your computer's display properties are set above 256 colors. Using 16 or 256 colors on your computer will produce dithering artifacts in the image, making the image appear to be of poor quality.

A2: The configuration on the Internet Camera image display is incorrect. Through the **Advanced>Image Setting** section of the Web management you need to adjust the image related parameters such as brightness, contrast, hue and power line frequency for fluorescent light . Please refer to the **Advanced>Image Setting** section on Page 49 for detailed information.

Frequently Asked Questions (continued)

How to PING Your IP Address

The PING (Packet Internet Groper) command can determine whether a specific IP address is accessible by sending a packet to the specific address and waiting for a reply. It can also provide a very useful tool to confirm if the IP address conflicts with Internet Camera over the network.

Follow the step-by-step procedure below to utilize the PING command but first you must disconnect Internet Camera from the network.

Start a DOS window.

Type ping x.x.x.x, where x.x.x.x is the IP address of the Internet Camera.

The replies, as illustrated below, will help diagnose any connection problems.

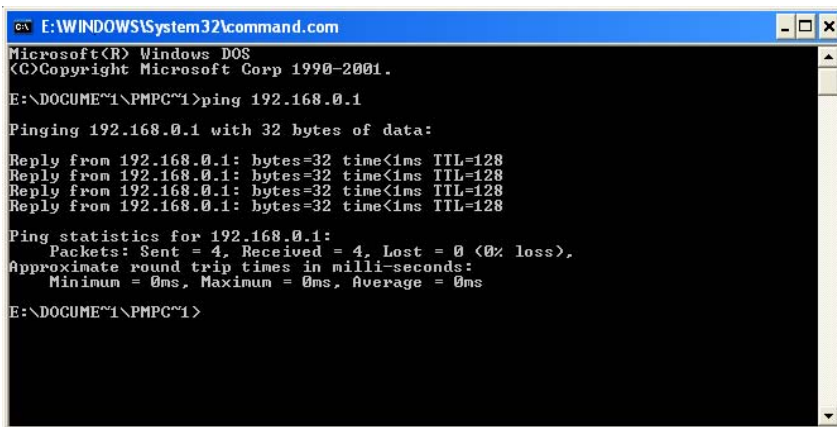

```
ex E:\WINDOWS\System32\command.com
Microsoft(R) Windows DOS
(C)Copyright Microsoft Corp 1990-2001.
E:\DOCUMENT1\PMPC~1>ping 192.168.0.1
Pinging 192.168.0.1 with 32 bytes of data:
Reply from 192.168.0.1: bytes=32 time<1ms TTL=128
Reply from 192.168.0.1: bytes=32 time<1ms TTL=128
Reply from 192.168.0.1: bytes=32 time<1ms TTL=128
Reply from 192.168.0.1: bytes=32 time<1ms TTL=128
Ping statistics for 192.168.0.1:
    Packets: Sent = 4, Received = 4, Lost = 0 (0% loss),
    Approximate round trip times in milli-seconds:
        Minimum = 0ms, Maximum = 0ms, Average = 0ms
E:\DOCUMENT1\PMPC~1>
```

Reset and Restore

There is a button hidden in the pinhole beside the Ethernet socket. It is used to **reset** the system or **restore** the factory default settings. Sometimes resetting the **DCS-3220G** will return the system back to a normal state. If the system still has problems after reset, restore the factory settings and install again:

- RESET:**
1. Lightly insert a paper clip (or a similar sized tool) into the reset hole on the back of the camera, press lightly and then release the button.
 2. The LED on the front of the camera will begin blinking red and green fast.
 3. When the LED stops the blinking fast and starts blinking once every second, the reset is completed.

- RESTORE:**
1. Insert the paper clip, or another similar tool, and press and continuously hold down the button recessed inside the reset hole.
 2. Wait for the LED on the front of the camera to blink red and green and hold the button through two cycles of blinking (about 5-7 seconds.)
 3. Withdraw the tool after the second cycle of the LED blinking and a factory restore has been completed.



Restoring the factory defaults will result in the loss of any previous settings and will require running the **IP Installer** to find the camera's IP address.

I/O Connector

I/O Connector Definition for the Internet Camera

The **DCS-3220G** provides a general I/O terminal block with one digital input and one relay switch for device control. Pin 1 and pin 2 can be connected to an external sensor and the state of voltage will be monitored from the initial state 'LOW'. The relay switch of pin 3 and pin 4 can be used to turn the external device on or off.

The I/O connector provides the physical interface for digital output (DO) and digital input (DI) that is used for connecting a diversity of external alarm devices to the Internet Camera such as IR-Sensors and alarm relays.

The digital input is used for connecting external alarm devices and once triggered images will be taken and e-mailed.

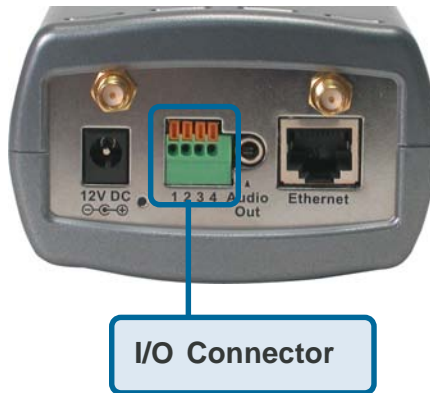

I/O Terminal Block:

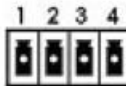

1 SW_COMMON	OUTPUT (open from SW_OPEN at initial state) (close with SW_OPEN when set DO to ON)
2 SW_NOPEN	OUTPUT (Max. 1A, 24VDC or 0.5A, 125VAC)
3 DI+	INPUT (Max. 50mA, 12VDC)
4 DI-	INPUT (Initial state of DI is low)

I/O Connector (continued)

DI/DO Connection Diagram

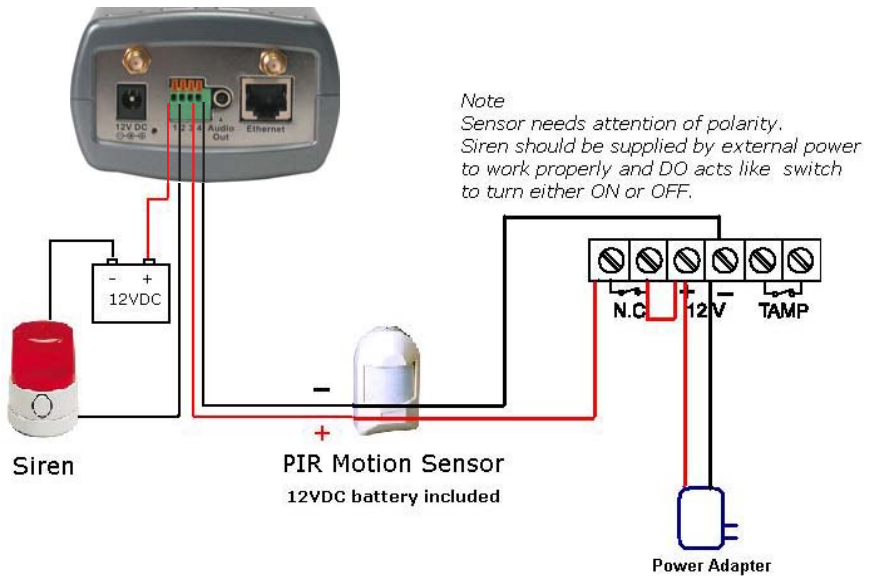

The above diagram shows a typical wiring configuration for a normally closed PIR motion sensor. Please refer to your specific motion sensor for the power supply connection to the device since this will be critical to the success of your installation. Note that the positive from the PIR is connected to the D- of the I/O port of the camera and the negative from the PIR is connected to the D+ of the camera I/O port.

Configuring Your Camera for External Trigger Based Recording

To configure your camera to record when triggered by an external device, you must first set your SMTP or FTP settings in order to send snapshots to your email account or FTP server.

I/O Connector (continued)

Configuring Your Camera for External Trigger Based Recording (continued)

Click the **Network** button under the **Advanced** tab to set the SMTP or FTP server settings for the **DCS-3220G**.

The screenshot shows the configuration page for a D-Link DCS-3220G camera. The 'Advanced' tab is active, and the 'Mail & FTP' option is selected in the left-hand menu. A callout box with a blue border and white background contains the text 'Click Mail & FTP' with a blue arrow pointing to the 'Mail & FTP' button. The main configuration area is titled 'Mail & FTP settings' and contains two sections: 'SMTP' and 'FTP'. The 'SMTP' section includes fields for '1st SMTP (mail) server', '1st SMTP account name', '1st SMTP password', '1st recipient email address', '2nd SMTP (mail) server', '2nd SMTP account name', '2nd SMTP password', '2nd recipient email address', and 'Sender email address'. The 'FTP' section includes fields for 'Local FTP server port' (set to 21), '1st FTP server', '1st FTP server port' (set to 21), '1st FTP user name' (set to root), '1st FTP password' (masked with ****), '1st FTP remote folder' (set to 123456), a checkbox for '1st FTP passive mode', '2nd FTP server', '2nd FTP server port' (set to 21), '2nd FTP user name', '2nd FTP password', '2nd FTP remote folder', and a checkbox for '2nd FTP passive mode'. At the bottom right, there are 'Apply' and 'Cancel' buttons.

In this window, enter the settings for the SMTP or FTP server to which recorded snapshots will be sent. For detailed information about each setting, please refer to **Configuration > Advanced > Mail & FTP** in the section titled “Using the DCS-3220G With an Internet Browser” (page 33). Click the apply button when finished.

I/O Connector (continued)

Configuring Your Camera for External Trigger Based Recording (continued)

Next, click the **Applications** button under the **Tools** tab to set the application settings for the **DCS-3220G**.

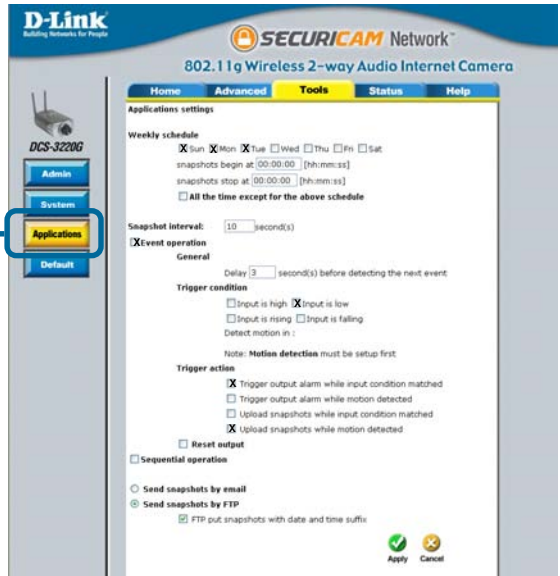

In this window, follow the steps below to set the application settings for snapshots to be sent to your email account or FTP server when triggered by a motion sensor or other external device:

- ① Select the weekdays you would like to record and enter the “Snapshots begin” time and “Snapshots end” time for the weekly schedule, or select “All the time except for the above schedule” if you want to enable full time snapshot recording.
- ② Check “Event operation.”
- ③ Set the delay “before detecting next event” to avoid continuous false alarms following the original event.
- ④ Set the “Snapshot Interval” to capture the direction of the moving object.
- ⑤ Check the trigger condition for input and motion detection (in this case “Input is Low”).
- ⑥ Check “Trigger output alarm while input condition matched” and “Upload snapshots while motion detected.”
- ⑦ Select to either send snapshots by email or by FTP.

Click the apply button when finished. You are now able to send snapshots, based on triggered recording, to your email account or FTP server.

Adjusting the Camera Focus

The **DCS-3220G** Internet Camera features an interchangeable C/CS-type lens that can be used for different applications as necessary. It supports rotational focus control so the lens can be adjusted to focus under normal and stable conditions to maximize the image quality of the Internet Camera.



Fixed Lens Assembly
Do NOT adjust

Camera Lens
Adjust focus by turning
clockwise or counterclockwise

To adjust the focus of the lens you will need to turn the lens slowly either clockwise or counterclockwise until the desired image appears. DO NOT overturn the lens in either direction as it will be out of focus and may damage the camera. Unless you want to substitute the lens DO NOT unscrew more than 1.0mm apart from the Fixed Lens Assembly.

To help you get the best image quality, keep in mind that while adjusting the camera's focus you can preview the image quality from your Web browser.

Note:

You can further adjust the Internet Camera's image quality through the web configuration under:

Configuration > Advanced > Video

Please refer to the **Configuration > Advanced > Video** section (page 46) for further details.

Replacing the Lens

Since the **DCS-3220G** Internet Camera is designed with a CS-mount, the lens equipped with the Internet Camera can be replaced with any standard C or CS-mount lens commonly used within the surveillance industry.

Follow the instructions below to replace the supplied lens with any C or CS-mount lens.

1. Unscrew the Internet Camera lens
2. When using a C-mount lens, attach the new lens to a CS to C-mount adapter.
3. Screw the new lens onto the Internet Camera.
4. Refer to **Adjusting the Internet Camera Focus** on the previous page.
5. Refresh the Web browser and monitor the results from the Internet Camera.



Warning!



Direct exposure to sunlight may cause permanent damage to the CCD sensor. Therefore do not expose the Internet Camera's lens directly to sunlight. When operation is required in glaring light environment, it is recommended to use an iris lens.

The Internet Camera is designed for indoor usage and if your application requires prolonged exposure to sunlight, a sun visor is recommended to protect the Internet Camera.

Technical Specifications

Remote management

Camera configuration and Camera system log can be accessed remotely via Internet Explorer 6.x or above Web browser.

Networking

Protocol

TCP/IP, HTTP, SMTP, FTP, NTP, DNS, DHCP, DDNS, and UPnP

Ethernet

Enhanced 802.11g wireless or 10BaseT or 100BaseT Fast Ethernet auto-negotiation

WLAN

2.4Ghz 802.11g DSSS CSMA/CA Protocol

Bit rate: up to 54Mbps*

Security: Up to 128-bit WEP

Antenna

2.4Ghz swivel type, monopole

Frequency

2.4Ghz-2.5Ghz

Impedance

50 Ohms nominal

Gain

2dBi typical

Video

Algorithm supported

MPEG-4 Simple Profile Mode

Audio

8K

Video resolution

Up to 30 fps at 176x120 / 176x144

Up to 30 fps at 352x240 / 352x288

Up to 10 fps at 704x480 / 704x576

General I/O

1 opto-isolated sensor input (max. 12VDC 50mA)

1 relay output (max. 24VDC 1A, 125VAC 0.5A)

*Maximum wireless signal rate based on IEEE Standard 802.11g specifications. Actual data throughput will vary. Network conditions and environmental factors, including volume of network traffic, building materials and construction, and network overhead lower actual data throughput rate.

Technical Specifications (continued)

Security

Administrator and user group protected
Password authentication

LED indicator

Bi-color status indicator

Camera specification

1/4 inch color CCD sensor
1.0Lux/F2.0
AGC/AWB
Electronic shutter: 1/60 ~ 1/15000 second
Standard CS mount type lens, 6mm, F1.8

Power

12VDC 1.5A, external power supply

Weight

328 grams (11.6 oz.)

Dimension

160mm(L) x 83.5mm(W) x 54mm(H) (6.3 in. x 3.3 in. x 2.1 in.)

Viewing system requirement

Protocol

Standard TCP/IP Internet Suite
ActiveX

Operating system

Microsoft Windows XP, 2000, ME or 98SE

Browser

Internet Explorer 6.x or above

Environmental

Operating

40° to 113° F

Storage

-4° to 158° F

Humidity

Max 95% RH

Safety

FCC class B
CE

Contacting Technical Support

Technical Support

You can find software updates and user documentation on the D-Link website.

D-Link provides free technical support for customers within the United States and within Canada for the duration of the warranty period on this product.

U.S. and Canadian customers can contact D-Link Technical Support through our website, or by phone.

Tech Support for customers within the United States:

D-Link Technical Support over the Telephone:

(877) 453-5465

24 hours a day, seven days a week.

D-Link Technical Support over the Internet:

<http://support.dlink.com>

email:support@dlink.com

Tech Support for customers within Canada:

D-Link Technical Support over the Telephone:

(800) 361-5265

Monday to Friday 7:30am to 12:00am EST

D-Link Technical Support over the Internet:

<http://support.dlink.ca>

email:support@dlink.ca

Time Zone Table

GMT stands for Greenwich Mean Time, which is the global time that all time zones are measured from.

(GMT-12:00) International Date Line West
(GMT-11:00) Midway Island, Samoa
(GMT-10:00) Hawaii
(GMT-09:00) Alaska
(GMT-08:00) Pacific Time (US & Canada); Tijuana
(GMT-07:00) Arizona
(GMT-07:00) Chihuahua, La Paz, Mazatlan
(GMT-07:00) Mountain Time (US & Canada)
(GMT-06:00) Central America
(GMT-06:00) Central Time (US & Canada)
(GMT-06:00) Guadalajara, Mexico City, Monterrey
(GMT-06:00) Saskatchewan
(GMT-05:00) Bogota, Lima, Quito
(GMT-05:00) Eastern Time (US & Canada)
(GMT-05:00) Indiana (East)
(GMT-04:00) Atlantic Time (Canada)
(GMT-04:00) Caracas, La Paz
(GMT-04:00) Santiago
(GMT-03:30) Newfoundland
(GMT-03:00) Brasilia
(GMT-03:00) Buenos Aires, Georgetown
(GMT-03:00) Greenland
(GMT-02:00) Mid-Atlantic
(GMT-01:00) Azores
(GMT-01:00) Cape Verde Is.
(GMT) Casablanca, Monrovia
(GMT) Greenwich Mean Time : Dublin, Edinburgh, Lisbon, London
(GMT+01:00) Amsterdam, Berlin, Bern, Rome, Stockholm, Vienna
(GMT+01:00) Belgrade, Bratislava, Budapest, Ljubljana, Prague
(GMT+01:00) Brussels, Copenhagen, Madrid, Paris
(GMT+01:00) Sarajevo, Skopje, Warsaw, Zagreb
(GMT+01:00) West Central Africa
(GMT+02:00) Athens, Istanbul, Minsk
(GMT+02:00) Bucharest
(GMT+02:00) Cairo
(GMT+02:00) Harare, Pretoria
(GMT+02:00) Helsinki, Kyiv, Riga, Sofia, Tallinn, Vilnius
(GMT+02:00) Jerusalem
(GMT+03:00) Baghdad
(GMT+03:00) Kuwait, Riyadh
(GMT+03:00) Moscow, St. Petersburg, Volgograd
(GMT+03:00) Nairobi

Time Zone Table (continued)

(GMT+03:30) Tehran
(GMT+04:00) Abu Dhabi, Muscat
(GMT+04:00) Baku, Tbilisi, Yerevan
(GMT+04:30) Kabul
(GMT+05:00) Ekaterinburg
(GMT+05:00) Islamabad, Karachi, Tashkent
(GMT+05:30) Chennai, Kolkata, Mumbai, New Delhi
(GMT+05:45) Kathmandu
(GMT+06:00) Almaty, Novosibirsk
(GMT+06:00) Astana, Dhaka
(GMT+06:00) Sri Jayawardenepura
(GMT+06:30) Rangoon
(GMT+07:00) Bangkok, Hanoi, Jakarta
(GMT+07:00) Krasnoyarsk
(GMT+08:00) Beijing, Chongqing, Hong Kong, Urumqi
(GMT+08:00) Irkutsk, Ulaan Bataar
(GMT+08:00) Kuala Lumpur, Singapore
(GMT+08:00) Perth
(GMT+08:00) Taipei
(GMT+09:00) Osaka, Sapporo, Tokyo
(GMT+09:00) Seoul
(GMT+09:00) Yakutsk
(GMT+09:30) Adelaide
(GMT+09:30) Darwin
(GMT+10:00) Brisbane
(GMT+10:00) Canberra, Melbourne, Sydney
(GMT+10:00) Guam, Port Moresby
(GMT+10:00) Hobart
(GMT+10:00) Vladivostok
(GMT+11:00) Magadan, Solomon Is., New Caledonia
(GMT+12:00) Auckland, Wellington
(GMT+12:00) Fiji, Kamchatka, Marshall Is.
(GMT+13:00) Nuku'alofa

Warranty USA only

Subject to the terms and conditions set forth herein, D-Link Systems, Inc. (“D-Link”) provides this Limited warranty for its product only to the person or entity that originally purchased the product from:

- D-Link or its authorized reseller or distributor and
- Products purchased and delivered within the fifty states of the United States, the District of Columbia, U.S. Possessions or Protectorates, U.S. Military Installations, addresses with an APO or FPO.

Limited Warranty: D-Link warrants that the hardware portion of the D-Link products described below will be free from material defects in workmanship and materials from the date of original retail purchase of the product, for the period set forth below applicable to the product type (“Warranty Period”), except as otherwise stated herein.

1-Year Limited Warranty for the Product(s) is defined as follows:

- Hardware (excluding power supplies and fans) One (1) Year
- Power Supplies and Fans One (1) Year
- Spare parts and spare kits Ninety (90) days

D-Link’s sole obligation shall be to repair or replace the defective Hardware during the Warranty Period at no charge to the original owner or to refund at D-Link’s sole discretion. Such repair or replacement will be rendered by D-Link at an Authorized D-Link Service Office. The replacement Hardware need not be new or have an identical make, model or part. D-Link may in its sole discretion replace the defective Hardware (or any part thereof) with any reconditioned product that D-Link reasonably determines is substantially equivalent (or superior) in all material respects to the defective Hardware. Repaired or replacement Hardware will be warranted for the remainder of the original Warranty Period from the date of original retail purchase. If a material defect is incapable of correction, or if D-Link determines in its sole discretion that it is not practical to repair or replace the defective Hardware, the price paid by the original purchaser for the defective Hardware will be refunded by D-Link upon return to D-Link of the defective Hardware. All Hardware (or part thereof) that is replaced by D-Link, or for which the purchase price is refunded, shall become the property of D-Link upon replacement or refund.

Limited Software Warranty: D-Link warrants that the software portion of the product (“Software”) will substantially conform to D-Link’s then current functional specifications for the Software, as set forth in the applicable documentation, from the date of original retail purchase of the Software for a period of ninety (90) days (“Warranty Period”), provided that the Software is properly installed on approved hardware and operated as contemplated in its documentation. D-Link further warrants that, during the Warranty Period, the magnetic media on which D-Link delivers the Software will be free of physical defects. D-Link’s sole obligation shall be to replace the non-conforming Software (or defective media) with software that substantially conforms to D-Link’s functional specifications for the Software or to refund at D-Link’s sole discretion. Except as otherwise agreed by D-Link in writing, the replacement Software is provided only to the original licensee, and is subject to the terms and conditions of the license granted by D-Link for the Software. Software will be warranted for the remainder of the original Warranty Period from the date of original retail purchase. If a material non-conformance is incapable of correction, or if D-Link determines in its sole discretion that it is not practical to replace the non-conforming Software, the price paid by the original licensee for the non-conforming Software will be refunded by D-Link; provided that the non-conforming Software (and all copies thereof) is first returned to D-Link. The license granted respecting any Software for which a refund is given automatically terminates.

Non-Applicability of Warranty: The Limited Warranty provided hereunder for hardware and software of D-Link’s products will not be applied to and does not cover any refurbished product and any product purchased through the inventory clearance or liquidation sale or other sales in which D-Link, the sellers, or the liquidators expressly disclaim their warranty obligation pertaining to the product and in that case, the product is being sold “As-Is” without any warranty whatsoever including, without limitation, the Limited Warranty as described herein, notwithstanding anything stated herein to the contrary.

Submitting A Claim: The customer shall return the product to the original purchase point based on its return policy. In case the return policy period has expired and the product is within warranty, the customer shall submit a claim to D-Link as outlined below:

- The customer must submit with the product as part of the claim a written description of the Hardware defect or Software nonconformance in sufficient detail to allow D-Link to confirm the same.
- The original product owner must obtain a Return Material Authorization (“RMA”) number from the Authorized D-Link Service Office and, if requested, provide written proof of purchase of the product (such as a copy of the dated purchase invoice for the product) before the warranty service is provided.

Warranty (continued)

USA only

- After an RMA number is issued, the defective product must be packaged securely in the original or other suitable shipping package to ensure that it will not be damaged in transit, and the RMA number must be prominently marked on the outside of the package. Do not include any manuals or accessories in the shipping package. D-Link will only replace the defective portion of the Product and will not ship back any accessories.
- The customer is responsible for all in-bound shipping charges to D-Link. No Cash on Delivery ("COD") is allowed. Products sent COD will either be rejected by D-Link or become the property of D-Link. Products shall be fully insured by the customer and shipped to **D-Link Systems, Inc., 17595 Mt. Herrmann, Fountain Valley, CA 92708**. D-Link will not be held responsible for any packages that are lost in transit to D-Link. The repaired or replaced packages will be shipped to the customer via UPS Ground or any common carrier selected by D-Link, with shipping charges prepaid. Expedited shipping is available if shipping charges are prepaid by the customer and upon request.

D-Link may reject or return any product that is not packaged and shipped in strict compliance with the foregoing requirements, or for which an RMA number is not visible from the outside of the package. The product owner agrees to pay D-Link's reasonable handling and return shipping charges for any product that is not packaged and shipped in accordance with the foregoing requirements, or that is determined by D-Link not to be defective or non-conforming.

What Is Not Covered: This limited warranty provided by D-Link does not cover: Products, if in D-Link's judgment, have been subjected to abuse, accident, alteration, modification, tampering, negligence, misuse, faulty installation, lack of reasonable care, repair or service in any way that is not contemplated in the documentation for the product, or if the model or serial number has been altered, tampered with, defaced or removed; Initial installation, installation and removal of the product for repair, and shipping costs; Operational adjustments covered in the operating manual for the product, and normal maintenance; Damage that occurs in shipment, due to act of God, failures due to power surge, and cosmetic damage; Any hardware, software, firmware or other products or services provided by anyone other than D-Link; Products that have been purchased from inventory clearance or liquidation sales or other sales in which D-Link, the sellers, or the liquidators expressly disclaim their warranty obligation pertaining to the product. Repair by anyone other than D-Link or an Authorized D-Link Service Office will void this Warranty.

Disclaimer of Other Warranties: EXCEPT FOR THE LIMITED WARRANTY SPECIFIED HEREIN, THE PRODUCT IS PROVIDED "AS-IS" WITHOUT ANY WARRANTY OF ANY KIND WHATSOEVER INCLUDING, WITHOUT LIMITATION, ANY WARRANTY OF MERCHANTABILITY, FITNESS FOR A PARTICULAR PURPOSE AND NON-INFRINGEMENT. IF ANY IMPLIED WARRANTY CANNOT BE DISCLAIMED IN ANY TERRITORY WHERE A PRODUCT IS SOLD, THE DURATION OF SUCH IMPLIED WARRANTY SHALL BE LIMITED TO NINETY (90) DAYS. EXCEPT AS EXPRESSLY COVERED UNDER THE LIMITED WARRANTY PROVIDED HEREIN, THE ENTIRE RISK AS TO THE QUALITY, SELECTION AND PERFORMANCE OF THE PRODUCT IS WITH THE PURCHASER OF THE PRODUCT.

Limitation of Liability: TO THE MAXIMUM EXTENT PERMITTED BY LAW, D-LINK IS NOT LIABLE UNDER ANY CONTRACT, NEGLIGENCE, STRICT LIABILITY OR OTHER LEGAL OR EQUITABLE THEORY FOR ANY LOSS OF USE OF THE PRODUCT, INCONVENIENCE OR DAMAGES OF ANY CHARACTER, WHETHER DIRECT, SPECIAL, INCIDENTAL OR CONSEQUENTIAL (INCLUDING, BUT NOT LIMITED TO, DAMAGES FOR LOSS OF GOODWILL, LOSS OF REVENUE OR PROFIT, WORK STOPPAGE, COMPUTER FAILURE OR MALFUNCTION, FAILURE OF OTHER EQUIPMENT OR COMPUTER PROGRAMS TO WHICH D-LINK'S PRODUCT IS CONNECTED WITH, LOSS OF INFORMATION OR DATA CONTAINED IN, STORED ON, OR INTEGRATED WITH ANY PRODUCT RETURNED TO D-LINK FOR WARRANTY SERVICE) RESULTING FROM THE USE OF THE PRODUCT, RELATING TO WARRANTY SERVICE, OR ARISING OUT OF ANY BREACH OF THIS LIMITED WARRANTY, EVEN IF D-LINK HAS BEEN ADVISED OF THE POSSIBILITY OF SUCH DAMAGES. THE SOLE REMEDY FOR A BREACH OF THE FOREGOING LIMITED WARRANTY IS REPAIR, REPLACEMENT OR REFUND OF THE DEFECTIVE OR NON-CONFORMING PRODUCT. THE MAXIMUM LIABILITY OF D-LINK UNDER THIS WARRANTY IS LIMITED TO THE PURCHASE PRICE OF THE PRODUCT COVERED BY THE WARRANTY. THE FOREGOING EXPRESS WRITTEN WARRANTIES AND REMEDIES ARE EXCLUSIVE AND ARE IN LIEU OF ANY OTHER WARRANTIES OR REMEDIES, EXPRESS, IMPLIED OR STATUTORY

Governing Law: This Limited Warranty shall be governed by the laws of the State of California. Some states do not allow exclusion or limitation of incidental or consequential damages, or limitations on how long an implied warranty lasts, so the foregoing limitations and exclusions may not apply. This limited warranty provides specific legal rights and the product owner may also have other rights which vary from state to state.

Warranty (continued)

USA only

Trademarks: D-Link is a registered trademark of D-Link Systems, Inc. Other trademarks or registered trademarks are the property of their respective manufacturers or owners.

Copyright Statement: No part of this publication or documentation accompanying this Product may be reproduced in any form or by any means or used to make any derivative such as translation, transformation, or adaptation without permission from D-Link Corporation/D-Link Systems, Inc., as stipulated by the United States Copyright Act of 1976. Contents are subject to change without prior notice. Copyright© 2002 by D-Link Corporation/D-Link Systems, Inc. All rights reserved.

CE Mark Warning: This is a Class B product. In a domestic environment, this product may cause radio interference, in which case the user may be required to take adequate measures.

FCC Statement: This equipment has been tested and found to comply with the limits for a Class B digital device, pursuant to part 15 of the FCC Rules. These limits are designed to provide reasonable protection against harmful interference in a residential installation. This equipment generates, uses, and can radiate radio frequency energy and, if not installed and used in accordance with the instructions, may cause harmful interference to radio communication. However, there is no guarantee that interference will not occur in a particular installation. If this equipment does cause harmful interference to radio or television reception, which can be determined by turning the equipment off and on, the user is encouraged to try to correct the interference by one or more of the following measures:

- Reorient or relocate the receiving antenna.
- Increase the separation between the equipment and receiver.
- Connect the equipment into an outlet on a circuit different from that to which the receiver is connected.
- Consult the dealer or an experienced radio/TV technician for help.

For detailed warranty outside the United States, please contact corresponding local D-Link office.

Registration

Register online your D-Link product at <http://support.dlink.com/register/>