

X S T A C K

USER MANUAL

PRODUCT MODEL: **xStack**[™] **DES-3800 SERIES**

LAYER 3 STACKABLE FAST ETHERNET MANAGED SWITCH

RELEASE 2

Information in this document is subject to change without notice.

© 2006 D-Link Computer Corporation. All rights reserved.

Reproduction in any manner whatsoever without the written permission of D-Link Computer Corporation is strictly forbidden.

Trademarks used in this text: D-Link and the D-LINK logo are trademarks of D-Link Computer Corporation; Microsoft and Windows are registered trademarks of Microsoft Corporation.

Other trademarks and trade names may be used in this document to refer to either the entities claiming the marks and names or their products. D-Link Computer Corporation disclaims any proprietary interest in trademarks and trade names other than its own.

April 2006 P/N 651ES3828025G

Table of Contents

Preface	ix
Intended Readers	x
Typographical Conventions	x
Notes, Notices, and Cautions	x
Safety Instructions	xi
Safety Cautions	xi
General Precautions for Rack-Mountable Products	xii
Protecting Against Electrostatic Discharge	xiii
Introduction.....	1
xStack DES-3800 Series	1
Gigabit Ethernet Technology	1
Switch Description	1
Features	2
Ports	2
Front-Panel Components	3
Rear Panel Description	6
Side Panel Description	7
Gigabit Ports	7
Installation.....	8
Package Contents	8
Before You Connect to the Network	8
Installing the Switch without the Rack	9
Installing the Switch in a Rack	9
Mounting the Switch in a Standard 19" Rack	10
Connecting DC Power to the DES-3828DC	11
RPS Installation	12
Connecting the Switch.....	16
Switch to End Node	16
Switch to Hub or Switch	16
Connecting To Network Backbone or Server	17
Introduction to Switch Management	18
Management Options	18
Web-based Management Interface	18
SNMP-Based Management	18
Connecting the Console Port (RS-232 DCE)	18
First Time Connecting to the Switch	20
Password Protection	20
SNMP Settings	21
IP Address Assignment	22
Web-based Switch Configuration.....	24

Introduction.....	24
Login to Web Manager	24
Web-based User Interface	25
Web Pages.....	26
Administration	27
IP Address.....	30
Port Configuration.....	33
Port Description	35
PoE Configuration.....	36
User Accounts	37
Port Mirroring	39
System Log Settings.....	40
System Severity Settings.....	42
SNTP Settings	43
Time Settings	43
Time Zone and DST.....	44
TFTP Services.....	47
Multiple Image Services	48
Firmware Information	48
Dual Configuration Services.....	49
Ping Test	50
SNMP Manager	51
SNMP Settings.....	51
SNMP User Table	52
SNMP View Table	54
SNMP Group Table.....	55
SNMP Community Table Configuration.....	56
SNMP Host Table	57
SNMP Engine ID	58
D-Link Single IP Management	59
Single IP Management (SIM) Overview	59
SIM Using the Web Interface.....	60
Topology.....	62
Tool Tips.....	64
Right Click	65
Menu Bar	68
Firmware Upgrade	70
Configuration File Backup/Restore.....	70
Upload Log File	70
Layer 2 Features	71
VLANs.....	71
Understanding IEEE 802.1p Priority.....	71
VLAN Description	71

IEEE 802.1Q VLANs.....	72
Guest VLANs.....	76
Double VLANs.....	77
Static VLAN Entry.....	78
GVRP Setting.....	80
Guest VLAN.....	81
Double VLAN.....	82
Trunking.....	84
Link Aggregation.....	85
LACP Port Settings.....	87
IGMP.....	88
IGMP Snooping.....	88
Static Router Port Settings.....	90
Spanning Tree.....	91
STP Bridge Global Settings.....	93
MST Configuration Identification.....	95
MSTP Port Information.....	97
STP Instance Settings.....	98
STP Port Settings.....	99
STP Port Information of Instance.....	101
Forwarding.....	102
Unicast Forwarding.....	102
Multicast Forwarding.....	102
Layer 3 Features	104
IP Multinetting.....	104
IP Interface Settings.....	105
MD5 Key Settings.....	107
Route Redistribution Settings.....	108
Static/Default Route Settings.....	109
Route Preference Settings.....	110
Static ARP Table.....	112
RIP.....	113
RIP Global Settings.....	114
RIP Interface Settings.....	115
OSPF.....	116
OSPF Global Settings.....	132
OSPF Area Setting.....	132
OSPF Interface Settings.....	134
OSPF Virtual Link Settings.....	136
OSPF Area Aggregation Settings.....	138
OSPF Host Route Settings.....	139
DHCP/BOOTP Relay.....	140
DHCP / BOOTP Relay Global Settings.....	140
DHCP/BOOTP Relay Interface Settings.....	143

DNS Relay	144
DNS Relay Global Settings.....	144
DNS Relay Static Settings.....	145
VRRP	146
VRRP Global Settings.....	146
VRRP Virtual Router Settings	146
VRRP Authentication Settings.....	150
IP Multicast Routing Protocol.....	151
IGMP Interface Settings.....	153
DVMRP Interface Configuration	154
DVMRP Global Settings.....	154
DVMRP Interface Settings.....	155
PIM-DM Interface Configuration	156
PIM-DM Configuration	156
PIM-DM Interface Configuration	156
QoS	158
Advantages of QoS	158
Understanding QoS.....	159
Port Bandwidth	160
QoS Scheduling Mechanism.....	161
QoS Output Scheduling	162
802.1p Default Priority	163
802.1p User Priority.....	164
WRED Settings.....	164
ACL	166
Access Profile Table	166
CPU Interface Filtering.....	179
CPU Interface Filtering Profile Table	179
Security	190
Traffic Control	190
Port Security.....	194
Port Lock Entries	195
Port Access Entity (802.1X)	196
802.1x Port-Based and MAC-Based Access Control	196
Understanding 802.1x Port-based and MAC-based Network Access Control	199
Port-Based Network Access Control.....	199
MAC-Based Network Access Control	200
Configure 802.1x Authenticator Parameter.....	201
Authentic RADIUS Server.....	203
Trusted Host.....	204
Access Authentication Control	205
Authentication Policy and Parameter Settings	206
Application Authentication Settings.....	206

Authentication Server Group	207
Authentication Server Host	208
Login Method Lists	210
Enable Method Lists	211
Configure Local Enable Password	213
Enable Admin	213
Traffic Segmentation.....	214
Secure Socket Layer (SSL).....	215
Download Certificate	215
Ciphersuite	215
SSH	218
SSH Server Configuration.....	218
SSH Authentication Mode and Algorithm Settings.....	219
SSH User Authentication	221
IP-MAC Binding.....	222
IP-MAC Binding Port	222
IP-MAC Binding Table.....	222
IP-MAC Binding Blocked.....	223
Limited IP Multicast Range	224
Web-based Access Control	225
Conditions and Limitations	225
Safeguard Engine	229
Monitoring.....	231
Device Status	231
CPU Utilization.....	232
Safeguard Engine Status	233
Port Utilization.....	234
Packets	235
Received (RX).....	235
UMB Cast (RX).....	237
Transmitted (TX)	239
Errors	241
Received (RX).....	241
Transmitted (TX)	243
Packet Size	245
Browse Router Port.....	247
Port Access Control	248
RADIUS Authentication	248
RADIUS Accounting	249
Authenticator State.....	250
MAC Address Table	251
IP Address Table.....	252
Browse Routing Table	253

Browse ARP Table	253
Browse IP Multicast Forwarding Table	254
IGMP Snooping Group	254
IGMP Snooping Forwarding.....	255
Browse IGMP Group Table	255
DVMRP Monitoring	256
Browse DVMRP Routing Table.....	256
Browse DVMRP Neighbor Table	256
Browse DVMRP Routing Next Hop Table.....	257
Browse PIM Neighbor Table	257
OSPF Monitoring.....	258
Browse OSPF LSDB Table.....	258
Browse OSPF Neighbor Table.....	259
Browse OSPF Virtual Neighbor Table.....	259
Browse PoE Status (for DES-3828P only).....	260
Browse WRED Settings.....	261
Switch Log.....	262
Switch Maintenance.....	263
Reset.....	263
Reboot System	264
Reboot System	264
Save Changes.....	265
Logout.....	265
Technical Specifications	266
Cables and Connectors	268
Cable Lengths.....	269
Glossary	270
Warrenties/Registration	273
Tech Support.....	280

Preface

The *xStack DES-3800 Series User Manual* is divided into sections that describe the system installation and operating instructions with examples.

Section 1, Introduction - Describes the Switch and its features.

Section 2, Installation- Helps you get started with the basic installation of the Switch and also describes the front panel, rear panel, side panels, and LED indicators of the Switch. Included in this section is a description of how to hook up the DC power supply for the DES-3828DC.

Section 3, Connecting the Switch - Tells how you can connect the Switch to your Ethernet/Fast Ethernet network.

Section 4, Introduction to Switch Management - Introduces basic Switch management features, including password protection, SNMP settings, IP address assignment and connecting devices to the Switch.

Section 5, Introduction to Web-based Switch Management - Talks about connecting to and using the Web-based switch management feature on the Switch.

Section 6, Administration- A detailed discussion about configuring the basic functions of the Switch, including Device Information, IP Address, Port Configuration, User Accounts, Port Mirroring, System Log Settings, System Severity Settings, SNMP Settings, MAC Notification Settings, TFTP Services, Multiple Image Services, Ping Test, SNMP Manager, and Single IP Management Settings.

Section 7, Layer 2 Features- A discussion of Layer 2 features of the Switch, including VLAN, Trunking, IGMP Snooping, Spanning Tree and Forwarding.

Section 8, Layer 3 Features- A discussion of Layer 3 features of the Switch, including IP Interface Settings, MD5 Key Settings, Route Redistribution Settings, Static/Dynamic Route Settings, Route Preference Settings, Static ARP Settings, RIP, OSPF, DHCP/BOOTP Relay, DNS Relay, VRRP and IP Multicast Routing Settings.

Section 9, QoS - Features information on QoS, including Bandwidth Control, QoS Scheduling Mechanism, QoS Output, Scheduling, 802.1P Default Priority, and 802.1P User Priority.

Section 10, ACL- Discussion on the ACL function of the Switch, including Access Profile Table and CPU Interface Filtering.

Section 11, Security – A discussion on the Security functions on the Switch, including Traffic Control, Port Security, Port Lock Entries, 802.1X, Trusted Host, Access Authentication Control, Traffic Segmentation, SSL, SSH, IP MAC Binding, Limited IP Multicast Range, Web-based Access Control and Safeguard Engine.

Section 12, Monitoring – Features information on Monitoring including Device Status, CPU Utilization, Port Utilization, Packets, Errors, Packet Size, Browse Router Port, Port Access Control, MAC Address, IP Address Table, Browse Routing Table, Browse ARP Table, Browse IP Multicast Forwarding, Switch History Log, IGMP Snooping Group, IGMP Snooping Forwarding, DVMRP Monitor, OSPF Monitor, Browse PoE Status, and Switch History Log.

Appendix A, Technical Specifications - Technical specifications for the DES-3828, DES-3828P, DES-3828DC and the DES-3852.

Appendix B, Cables and Connectors - Describes the RJ-45 receptacle/connector, straight through and crossover cables and standard pin assignments.

Appendix C, Cable Lengths - Information on cable types and maximum distances.

Glossary - Lists definitions for terms and acronyms used in this document.

Intended Readers

The *xStack DES-3800 Series User Manual* contains information for setup and management of the Switch. The term, “the Switch” will be used when referring to all three switches. This manual is intended for network managers familiar with network management concepts and terminology.

Typographical Conventions

Convention	Description
[]	In a command line, square brackets indicate an optional entry. For example: [copy filename] means that optionally you can type copy followed by the name of the file. Do not type the brackets.
Bold font	Indicates a button, a toolbar icon, menu, or menu item. For example: Open the File menu and choose Cancel . Used for emphasis. May also indicate system messages or prompts appearing on your screen. For example: You have mail. Bold font is also used to represent filenames, program names and commands. For example: use the copy command.
Boldface Typewriter Font	Indicates commands and responses to prompts that must be typed exactly as printed in the manual.
Initial capital letter	Indicates a window name. Names of keys on the keyboard have initial capitals. For example: Click Enter.
<i>Italics</i>	Indicates a window name or a field. Also can indicate a variables or parameter that is replaced with an appropriate word or string. For example: type filename means that you should type the actual filename instead of the word shown in italic.
Menu Name > Menu Option	Menu Name > Menu Option Indicates the menu structure. Device > Port > Port Properties means the Port Properties menu option under the Port menu option that is located under the Device menu.

Notes, Notices, and Cautions



A **NOTE** indicates important information that helps you make better use of your device.



A **NOTICE** indicates either potential damage to hardware or loss of data and tells you how to avoid the problem.



A **CAUTION** indicates a potential for property damage, personal injury, or death.

Safety Instructions

Use the following safety guidelines to ensure your own personal safety and to help protect your system from potential damage. Throughout this document, the caution icon () is used to indicate cautions and precautions that you need to review and follow.



Safety Cautions

To reduce the risk of bodily injury, electrical shock, fire, and damage to the equipment, observe the following precautions.

- Observe and follow service markings.
 - Do not service any product except as explained in your system documentation.
 - Opening or removing covers that are marked with the triangular symbol with a lightning bolt may expose you to electrical shock.
 - Only a trained service technician should service components inside these compartments.
- If any of the following conditions occur, unplug the product from the electrical outlet and replace the part or contact your trained service provider:
 - The power cable, extension cable, or plug is damaged.
 - An object has fallen into the product.
 - The product has been exposed to water.
 - The product has been dropped or damaged.
 - The product does not operate correctly when you follow the operating instructions.
- Keep your system away from radiators and heat sources. Also, do not block cooling vents.
- Do not spill food or liquids on your system components, and never operate the product in a wet environment. If the system gets wet, see the appropriate section in your troubleshooting guide or contact your trained service provider.
- Do not push any objects into the openings of your system. Doing so can cause fire or electric shock by shorting out interior components.
- Use the product only with approved equipment.
- Allow the product to cool before removing covers or touching internal components.
- Operate the product only from the type of external power source indicated on the electrical ratings label. If you are not sure of the type of power source required, consult your service provider or local power company.
- To help avoid damaging your system, be sure the voltage on the power supply is set to match the power available at your location:
 - 115 volts (V)/60 hertz (Hz) in most of North and South America and some Far Eastern countries such as South Korea and Taiwan
 - 100 V/50 Hz in eastern Japan and 100 V/60 Hz in western Japan
 - 230 V/50 Hz in most of Europe, the Middle East, and the Far East
 - –48 VDC for DC power supply unit on DES-3828DC DC only
- Also, be sure that attached devices are electrically rated to operate with the power available in your location.
- Use only approved power cable(s). If you have not been provided with a power cable for your system or for any AC-powered option intended for your system, purchase a power cable that is approved for use in your country. The power cable must be rated for the product and for the voltage and current marked on the product's electrical ratings label. The voltage and current rating of the cable should be greater than the ratings marked on the product.

- To help prevent electric shock, plug the system and peripheral power cables into properly grounded electrical outlets. These cables are equipped with three-prong plugs to help ensure proper grounding. Do not use adapter plugs or remove the grounding prong from a cable. If you must use an extension cable, use a 3-wire cable with properly grounded plugs.
- Observe extension cable and power strip ratings. Make sure that the total ampere rating of all products plugged into the extension cable or power strip does not exceed 80 percent of the ampere ratings limit for the extension cable or power strip.
- To help protect your system from sudden, transient increases and decreases in electrical power, use a surge suppressor, line conditioner, or uninterruptible power supply (UPS).
- Position system cables and power cables carefully; route cables so that they cannot be stepped on or tripped over. Be sure that nothing rests on any cables.
- Do not modify power cables or plugs. Consult a licensed electrician or your power company for site modifications. Always follow your local/national wiring rules.
- When connecting or disconnecting power to hot-pluggable power supplies, if offered with your system, observe the following guidelines:
 - Install the power supply before connecting the power cable to the power supply.
 - Unplug the power cable before removing the power supply.
 - If the system has multiple sources of power, disconnect power from the system by unplugging all power cables from the power supplies.
- Move products with care; ensure that all casters and/or stabilizers are firmly connected to the system. Avoid sudden stops and uneven surfaces.



General Precautions for Rack-Mountable Products

Observe the following precautions for rack stability and safety. Also, refer to the rack installation documentation accompanying the system and the rack for specific caution statements and procedures.

- Systems are considered to be components in a rack. Thus, "component" refers to any system as well as to various peripherals or supporting hardware.
- Before working on the rack, make sure that the stabilizers are secured to the rack, extended to the floor, and that the full weight of the rack rests on the floor. Install front and side stabilizers on a single rack or front stabilizers for joined multiple racks before working on the rack.
- Always load the rack from the bottom up, and load the heaviest item in the rack first.
- Make sure that the rack is level and stable before extending a component from the rack.
- Use caution when pressing the component rail release latches and sliding a component into or out of a rack; the slide rails can pinch your fingers.
- After a component is inserted into the rack, carefully extend the rail into a locking position, and then slide the component into the rack.
- Do not overload the AC supply branch circuit that provides power to the rack. The total rack load should not exceed 80 percent of the branch circuit rating.
- Ensure that proper airflow is provided to components in the rack.
- Do not step on or stand on any component when servicing other components in a rack.



NOTE: A qualified electrician must perform all connections to DC power and to safety grounds. All electrical wiring must comply with applicable local, regional or national codes and practices.



CAUTION: Never defeat the ground conductor or operate the equipment in the absence of a suitably installed ground conductor. Contact the appropriate electrical inspection authority or an electrician if you are uncertain that suitable grounding is available.



CAUTION: The system chassis must be positively grounded to the rack cabinet frame. Do not attempt to connect power to the system until grounding cables are connected. A qualified electrical inspector must inspect completed power and safety ground wiring. An energy hazard will exist if the safety ground cable is omitted or disconnected.



CAUTION: Do not replace the battery with an incorrect type. The risk of explosion exists if the replacement battery is not the correct lithium battery type. Dispose of used batteries according to the instructions.

Protecting Against Electrostatic Discharge

Static electricity can harm delicate components inside your system. To prevent static damage, discharge static electricity from your body before you touch any of the electronic components, such as the microprocessor. You can do so by periodically touching an unpainted metal surface on the chassis.

You can also take the following steps to prevent damage from electrostatic discharge (ESD):

1. When unpacking a static-sensitive component from its shipping carton, do not remove the component from the antistatic packing material until you are ready to install the component in your system. Just before unwrapping the antistatic packaging, be sure to discharge static electricity from your body.
2. When transporting a sensitive component, first place it in an antistatic container or packaging.
3. Handle all sensitive components in a static-safe area. If possible, use antistatic floor pads, workbench pads and an antistatic grounding strap.

Section 1

Introduction

xStack DES-3800 Series

Gigabit Ethernet Technology

Switch Description

Features

Ports

Front-Panel Components

Side Panel Description

Rear Panel Description

Gigabit Combo Ports

xStack DES-3800 Series

The DES-3800 switch series is a member of the D-Link xStack switch family. xStack is a complete family of stackable devices that ranges from edge 10/100Mbps switches to core Gigabit switches. xStack provides unsurpassed performance, fault tolerance, scalable flexibility, robust security, standard-based interoperability and an impressive support for 10 Gigabit technology to future-proof departmental and enterprise network deployments with an easy migration path.

The following manual describes the installation, maintenance and configurations concerning members of the D-Link DES-3800 switch series, including the DES-3828, DES-3828P, DES-3828DC and the DES-3852. These four switches are identical in configurations (except for PoE Functions on the DES-3828P) and very similar in basic hardware and consequentially, most of the information in this manual will be universal to the total group of Switches. Corresponding screen pictures of the web manager may be taken from any one of these switches but the configuration will be identical, except for varying port counts. For the remainder of this document, we will refer to the DES-3800 as the switch in question for examples, configurations and explanations.

Gigabit Ethernet Technology

Gigabit Ethernet is an extension of IEEE 802.3 Ethernet utilizing the same packet structure, format, and support for CSMA/CD protocol, full duplex, flow control, and management objects, but with a tenfold increase in theoretical throughput over 100Mbps Fast Ethernet and a one hundred-fold increase over 10Mbps Ethernet. Since it is compatible with all 10Mbps and 100Mbps Ethernet environments, Gigabit Ethernet provides a straightforward upgrade without wasting a company's existing investment in hardware, software, and trained personnel.

The increased speed and extra bandwidth offered by Gigabit Ethernet are essential to coping with the network bottlenecks that frequently develop as computers and their busses get faster and more users using applications that generate more traffic. Upgrading key components, such as your backbone and servers to Gigabit Ethernet can greatly improve network response times as well as significantly speed up the traffic between your sub networks.

Gigabit Ethernet enables fast optical fiber connections to support video conferencing, complex imaging, and similar data-intensive applications. Likewise, since data transfers occur 10 times faster than Fast Ethernet, servers outfitted with Gigabit Ethernet NIC's are able to perform 10 times the number of operations in the same amount of time.

In addition, the phenomenal bandwidth delivered by Gigabit Ethernet is the most cost-effective method to take advantage of today and tomorrow's rapidly improving switching and routing internetworking technologies.

Switch Description

The Switch is equipped with unshielded twisted-pair (UTP) cable ports providing dedicated 10 or 100 Mbps bandwidth. The Switch has twenty-four 10/100BASE-TX ports for the DES-3828, DES-3828P and DES-3828DC, and forty-eight 10/100BASE-TX ports for the DES-3852, all of which are Auto MDI-X/MDI-II convertible ports that can be used for uplinking to another switch. These ports can be used for connecting PCs, printers, servers, hubs, routers, switches and other networking devices. The dual speed ports use standard twisted-pair cabling and are ideal for segmenting networks into small, connected sub networks for superior performance. Each 10/100 port can support up to 200 Mbps of throughput in full-duplex mode. In addition, the Switch

has two combo 1000 Base-T/SFP ports on the front panel and two 1000 Base-T on the back. These gigabit combo ports are ideal for connecting to a server or network backbone. See the “Ports” section below for differences between the front and rear Gigabit combo ports.

This Switch enables the network to use some of the most demanding multimedia and imaging applications concurrently with other user applications without creating bottlenecks. The built-in console interface can be used to configure the Switch's settings for priority queuing, VLANs, and port trunk groups, port monitoring, and port speed.

Features

- IEEE 802.3ad Link Aggregation Control Protocol support.
- IEEE 802.1x Port-based and MAC-based Access Control
- IEEE 802.1Q VLAN
- IEEE 802.1D Spanning Tree, IEEE 802.1W Rapid Spanning Tree and IEEE 802.1s Multiple Spanning Tree support
- Access Control List (ACL) support
- Single IP Management support
- Access Authentication Control utilizing TACACS, XTACACS and TACACS+
- Dual Image Firmware
- Simple Network Time Protocol support
- MAC Notification support
- System and Port Utilization support
- System Log Support
- Support port-based enable and disable
- Address table: Supports up to 16K MAC addresses per device
- Supports a packet buffer of up to 32M bytes
- Supports Port-based VLAN Groups
- Port Trunking with flexible load distribution and fail-over function
- IGMP Snooping support
- SNMP support
- Secure Sockets Layer (SSL) and Secure Shell (SSH) support
- Port Mirroring support
- WRED support
- Web-based Access Control
- MIB support for:
 - RFC1213 MIB II
 - RFC1493 Bridge
 - RFC2819 RMON
 - RFC2665 Ether-like MIB
 - RFC2863 Interface MIB
 - Private MIB
 - RFC2674 for 802.1p
 - IEEE 802.1x MIB
- IEEE 802.3x flow control in full duplex mode
- IEEE 802.1p Priority Queues
- IEEE 802.3u 100BASE-TX compliant
- RS-232 DCE console port for Switch management
- Provides parallel LED display for port status such as link/act, speed, etc.
- IEEE 802.3 10BASE-T compliant
- High performance switching engine performs forwarding and filtering at wire speed, maximum 14, 881 packets/sec on each 10Mbps Ethernet port, and maximum 148,810 packet/sec on 100Mbps Fast Ethernet port.
- Full- and half-duplex for both 10Mbps and 100Mbps connections. Full duplex allows the switch port to simultaneously transmit and receive data. It only works with connections to full-duplex-capable end stations and switches. Connections to a hub must take place at half-duplex

- Support broadcast storm filtering
- Non-blocking store and forward switching scheme capability to support rate adaptation and protocol conversion
- Supports by-port Egress/Ingress rate control.
- Efficient self-learning and address recognition mechanism enables forwarding rate at wire speed

Ports

The Switch provides twenty-four 10/100BASE-TX ports for the DES-3828, DES-3828P and DES-3828DC, and forty-eight 10/100BASE-TX ports for the DES-3852. All 10/100BASE-TX ports comply with the following standards:

- IEEE 802.3
- IEEE 802.3u
- Support Half/Full-Duplex operations
- All ports support Auto MDI-X/MDI-II cross over
- Support back pressure for Half-duplex mode
- IEEE 802.3x Flow Control support for Full-Duplex mode.



NOTE: On the DES-3828P, all twenty-four 10/100BASE-TX ports also comply with the IEEE 802.3af standard.

The Switch provides two 1000 Base-T/SFP combo ports on the front panel for all models. Both 1000BASE-T ports comply with the following standards:

- IEEE 802.3
- IEEE 802.3u
- IEEE 802.3ab
- Support Full-Duplex operations
- IEEE 802.3x Flow Control support for Full-Duplex mode
- IEEE 802.3z

Both SFP ports support the following transceivers:

- DEM-310GT (1000BASE-LX)
- DEM-311GT (1000BASE-SX)
- DEM-314GT (1000BASE-LH)
- DEM-315GT (1000BASE-ZX)

The Switch provides two 1000 Base-T ports on the rear panel. Both 1000BASE-T ports comply with the following standards:

- IEEE 802.3
- IEEE 802.3u
- IEEE 802.3ab
- Support Full-Duplex operations
- IEEE 802.3x Flow Control support for Full-Duplex mode



NOTE: The SFP combo ports on the Switch cannot be used simultaneously with the corresponding 1000BASE-T ports. If both ports are in use at the same time (ex. port 25 of the SFP and port 25 of the 1000BASE-T), the SFP ports will take priority over the combo ports and render the 1000BASE-T ports inoperable.

Front-Panel Components

The front panel of the Switch provides twenty-four 10/100BASE-TX ports for the DES-3828, DES-3828P and DES-3828DC, and forty-eight 10/100BASE-TX ports for the DES-3852, two 1000 Base-T/SFP combo ports, and an RS-232 console port (for the DES-3828, DES-3828P and DES-3828DC only). DES-3828P also includes a Mode Select button for changing the mode Link/Act/State to PoE.

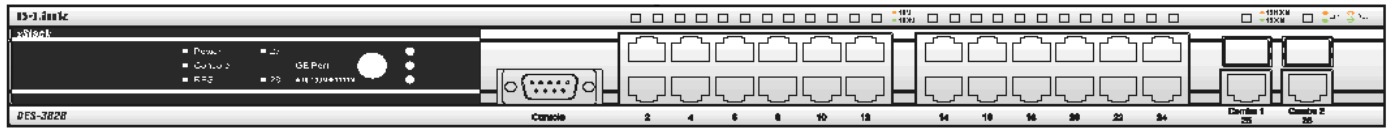

Figure 1- 1. Front Panel of the DES-3828

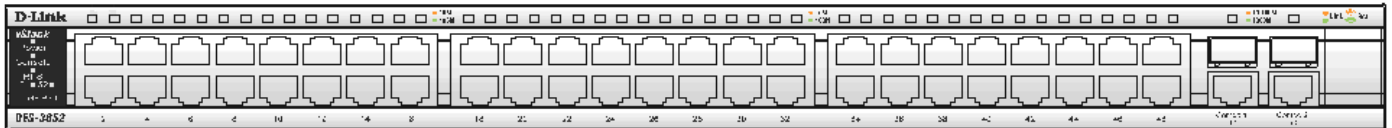

Figure 1- 2. Front Panel of the DES-3852

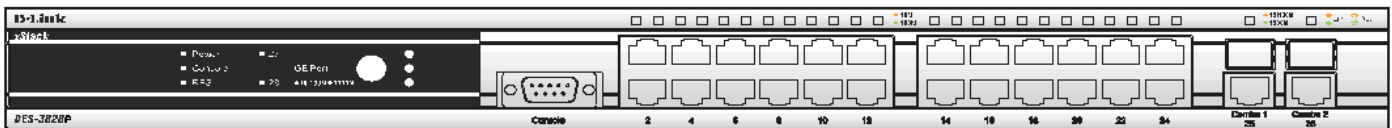

Figure 1- 3. Front Panel of the DES-3828P

DES-3828P LEDs

LED indicators display the status of the Switch and the network. The front panel of DES-3828P has LED indicators for power, console, RPS, 27GE (rear port), 28 GE (rear port), Link/Act/Speed, PoE, for each of the twenty-four 10/100 Mbps Ethernet ports, and for the two 1000BASE-T/SFP ports.

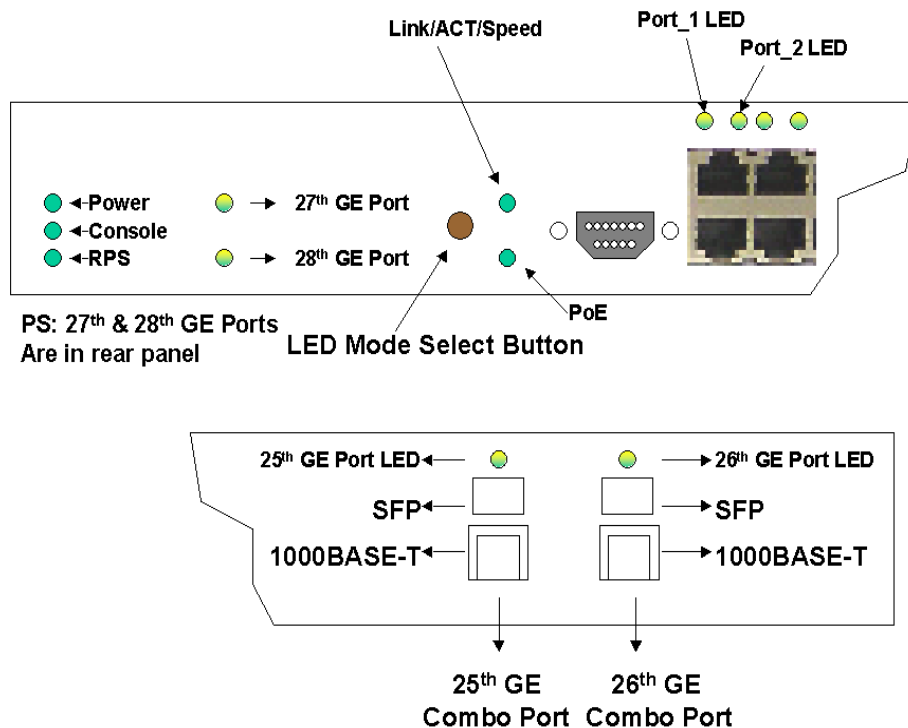

Figure 1- 4. Front Panel View of the DES-3828P

DES-3828/DES-3828DC LEDs

The front panel of DES-3828/DES-3828DC has LED indicators for power, console, RPS (DES-3828 only), 27GE (rear port), 28 GE (rear port), for each of the twenty-four 10/100 Mbps Ethernet ports, and for the two 1000BASE-T/SFP ports.

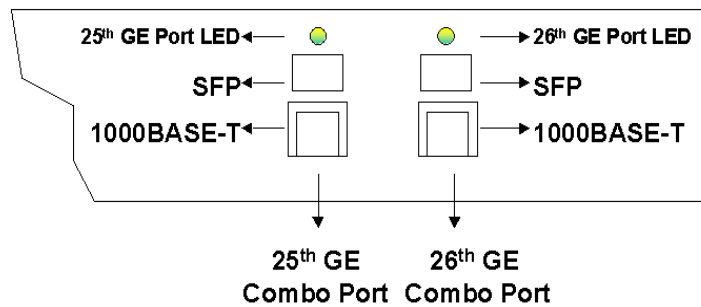
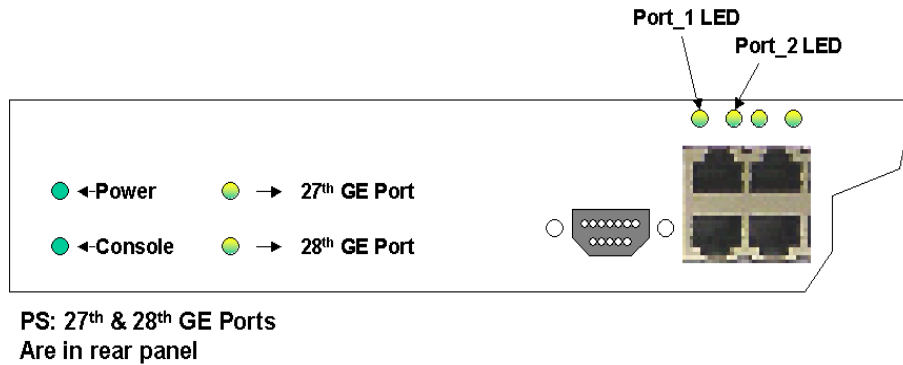

Figure 1- 5. Front Panel View of the DES-3828DC

DES-3852 LEDs

The front panel of DES-3852 has LED indicators for power, console, RPS, port 49 GE, port 50 GE, port 51 GE (rear port), port 52 GE (rear port), for each of the forty-eight 10/100 Mbps Ethernet ports, and for the two 1000BASE-T/SFP ports.

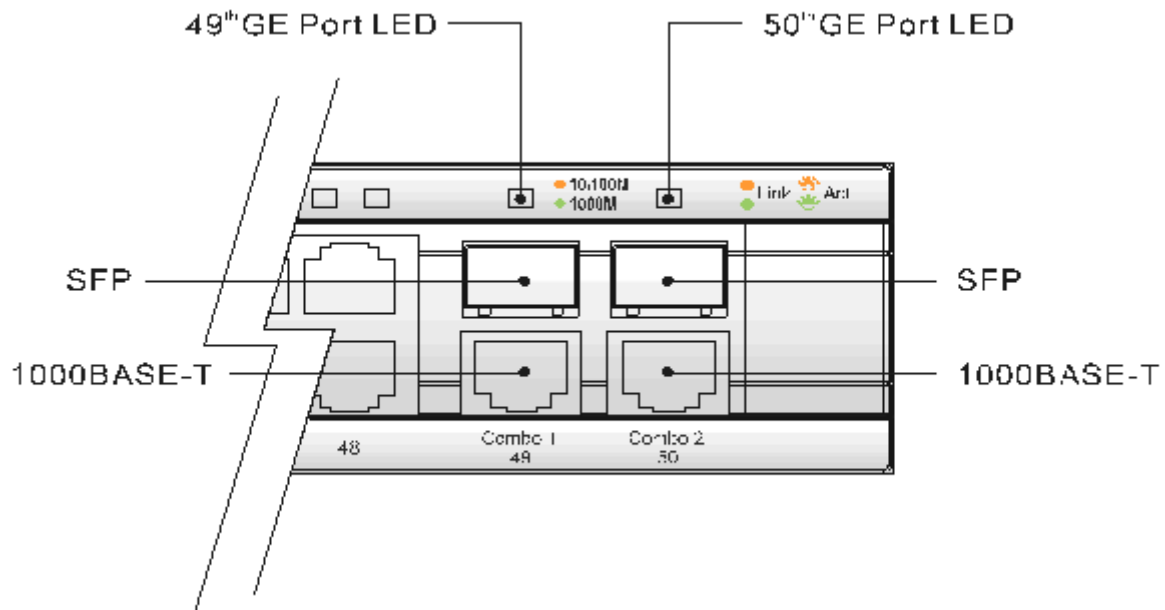

Figure 1- 6. LED Indicators for the DES-3852

The following table describes the LEDs for DES-3828/DES-3828P/DES-3828DC/DES-3852:

LED	Description
Power	Off – Power Off Solid Green – Power On
Console	Solid Green – Switch is being logged in to via the out-of-band/local console management through the RS-232 console port Blinking Green – POST is in progress
RPS (excluding DES-3828DC)	Off – RPS off Solid green – RPS in use
Ports 27, 28 GE (DES-3828/DES-3828P/DES-3828DC) Ports 51, 52 GE (DES-3852)	Ports 27 and 28 (51 and 52) represent the 1000BASE-T ports located on the rear panel of the Switch. These port LEDs will light two different colors for 100Mbps and 1000Mbps: <ul style="list-style-type: none"> • Solid Green – Link for 1000Mbps • Blinking Green – Activity for 1000Mbps • Solid Amber – Link for 100Mbps • Blinking Amber – Activity for 100Mbps • Off – Link down
Link/Act/Speed and PoE (DES-3828P only)	To change the LED mode from Link/Act/Speed to PoE and vice versa, press the LED Mode Select Button. The Link/Act/Speed LED will light solid green when selected and will shut off when PoE is selected. Likewise, when Link/Act/Speed is selected, the PoE LED shuts off and the Link/Act/Speed LED lights solid green.
Ports 1-24 (1-48)	One row of LEDs for each port is located above the ports on the front panel. The first LED is for the top port and the second one is for the bottom ports. These port LEDs display the following information: For Link/Act/Speed Mode: <ul style="list-style-type: none"> • Solid Green – Link for 100Mbps • Blinking Green – Activity for 100Mbps • Solid Amber – Link for 10Mbps • Blinking Amber – Activity for 10Mbps • Off – Link down For PoE Mode: (DES-3828P only) <ul style="list-style-type: none"> • Solid Green – Power feeding (802.3af-compliant PD was detected, legacy PD detected) • Blinking Amber – A blinking amber LED may signify any of the following: PoE port ERROR (non-standard PD connected, Under load state according to 802.3af (current is below I min), Overload state according to 802.3af (current is above Icut), hardware problems preventing port operation, power budget exceeded, short condition was detected at a port delivering power, temperature overload at the port, succession of Underload and Overload states caused port shutdown (may be caused by a PD's DC/DC fault)...etc.) • Off – No power feeding (no PD detected, or no connection)
Ports 25, 26 combo GE (DES-3828/DES-3828P/DES-3828DC) Ports 49, 50 combo GE (DES-3852)	Ports 25 and 26 (49, 50) represent the 1000BASE-T/SFP ports located on the front panel of the Switch. These port LEDs will display the following information: <ul style="list-style-type: none"> • Solid Green – Link for 1000Mbps • Blinking Green – Activity for 1000Mbps • Solid Amber – Link for 100Mbps • Blinking Amber – Activity for 100Mbps • Off – Link down

Rear Panel Description

The rear panels of DES-3828, DES-3828DC, DES-3828P and DES-3852 are described separately below.

DES-3828

The rear panel of DES-3828 contains ports 27 and 28, (1000BASE-TX), an AC power connector, and an outlet for an optional external RPS.

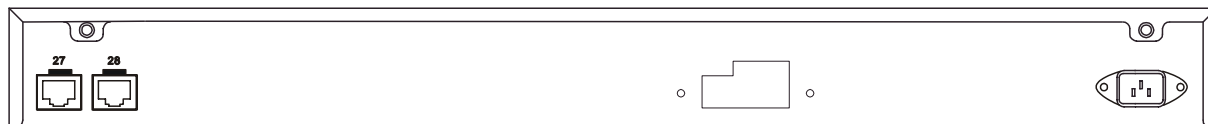

Figure 1- 7. Rear panel view of the DES-3828

For details on ports 27 and 28, see the “Ports” description above. The rear panel includes an outlet for an optional external redundant power supply. When power fails, the optional external RPS will take over all the power immediately and automatically. The AC power connector is a standard three-pronged connector that supports the power cord. Plug-in the female connector of the provided power cord into this socket, and the male side of the cord into a power outlet. The Switch automatically adjusts its power setting to any supply voltage in the range from 100 ~ 240 VAC at 50 ~ 60 Hz.

DES-3828P

The rear panel of DES-3828P contains ports 27 and 28, (1000BASE-TX), a heat vent, an AC power connector, and an outlet for an optional external RPS.

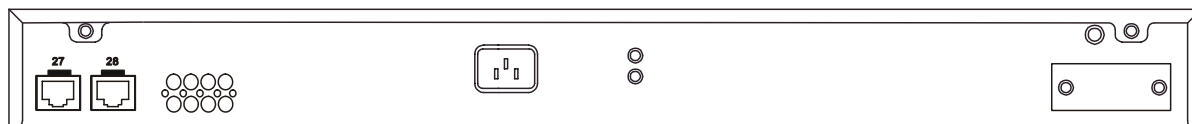

Figure 1- 8. Rear Panel view of DES-3828P

For details on ports 27 and 28, see the “Ports” description above. The rear panel includes a heat vent for the system fan. The system fan is used to dissipate heat. Do not block this opening, and leave at least 6 inches of space at the rear of the Switch for proper ventilation. Be reminded that without proper heat dissipation and air circulation, system components might overheat, which could lead to system failure. The rear panel also includes an outlet for an optional external redundant power supply. When power fails, the optional external RPS will take over all the power immediately and automatically. The AC power connector is a standard three-pronged connector that supports the power cord. Plug-in the female connector of the provided power cord into this socket, and the male side of the cord into a power outlet. The Switch automatically adjusts its power setting to any supply voltage in the range from 100 ~ 240 VAC at 50 ~ 60 Hz. The maximum output capacity for PoE is 370W. The default power feed for PoE is set at 15.4W per port, but can be set from 1-16.8W per port. See the PoE Configuration in Section 6 for instructions on how to change this setting.

DES-3828DC

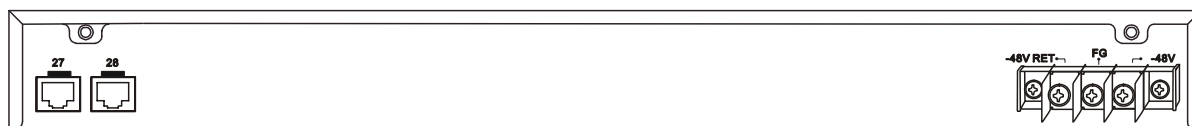

Figure 1- 9. Rear panel view of DES-3828DC

The rear panel of the DC power version of the Switch includes ports 27 and 28, (1000BASE-TX), and an opening designed to accommodate the DC power wiring assembly. See the installation instructions in Section 2 for details.

DES-3852

The rear panel of the DES-3852 contains ports 51 and 52, (1000BASE-TX), an AC power connector, an RS-232 console port and an outlet for an optional external RPS.

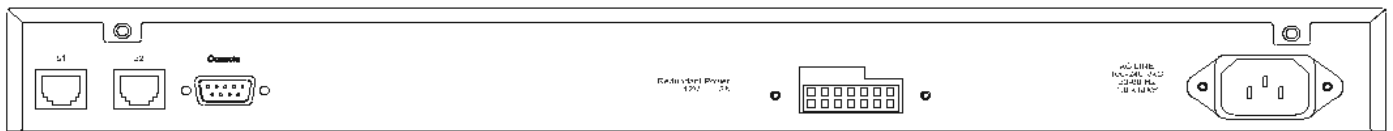

Figure 1- 10. Rear Panel of the DES-3852

Side Panel Description

The right-hand side panel of the Switch contains a system fan and ventilation along the entire right side. The left hand panel includes a system fan and a heat vent. The system fans are used to dissipate heat. Do not block these openings on either side of the Switch. Leave at least 6 inches of space at the rear and sides of the Switch for proper ventilation. Be reminded that without proper heat dissipation and air circulation, system components might overheat, which could lead to system failure.

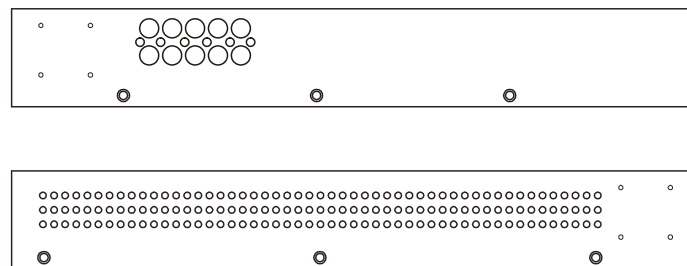

Figure 1- 11. Side Panels

Gigabit Ports

In addition to the twenty-four (forty-eight for DES-3852) 10/100 Mbps ports, the Switch features two 1000BASE-T/SFP Gigabit Ethernet Combo ports on the front panel, and two 1000BASE-T copper ports on the rear panel. The diagrams below show Gigabit ports 25 and 26 (49 and 50) on the far right of the front panel. Gigabit ports 27 and 28 (51 and 52) are on the far left of the rear panel. Please note that PoE is not supported for any Gigabit Ethernet ports.

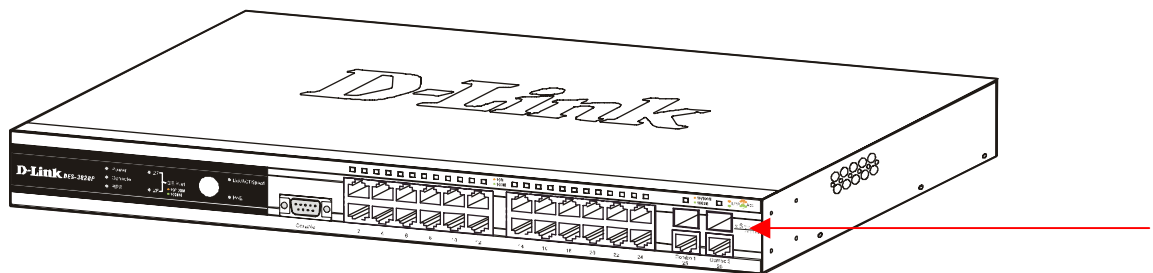

Figure 1- 12. Front Panel Mini-GBIC ports

SECTION 2

Installation

Package Contents

Before You Connect to the Network

Installing the Switch without the Rack

Rack Installation

Power On

Connecting DC Power to DES-3828DC

RPS Installation

Package Contents

Open the shipping carton of the Switch and carefully unpack its contents. The carton should contain the following items:

- One Stand-alone Switch
- One AC power cord (excluding DES-3828DC)
- This Manual on CD
- Mounting kit (two brackets and screws)
- Four rubber feet with adhesive backing
- RS-232 console cable

If any item is missing or damaged, please contact your local D-Link Reseller for replacement.

Before You Connect to the Network

The site where you install the Switch may greatly affect its performance. Please follow these guidelines for setting up the Switch.

- Install the Switch on a sturdy, level surface that can support at least 4.24kg (9.35lbs) of weight for DES-3828/DES-3828DC/DES-3852, or 6.02kg (13.27lbs) for DES-3828P. Do not place heavy objects on the Switch.
- The power outlet should be within 1.82 meters (6 feet) of the Switch.
- Visually inspect the power cord and see that it is fully secured to the AC/DC power port.
- Make sure that there is proper heat dissipation from and adequate ventilation around the Switch. Leave at least 10 cm (4 inches) of space at the front and rear of the Switch for ventilation.
- Install the Switch in a fairly cool and dry place for the acceptable temperature and humidity operating ranges.
- Install the Switch in a site free from strong electromagnetic field generators (such as motors), vibration, dust, and direct exposure to sunlight.
- When installing the Switch on a level surface, attach the rubber feet to the bottom of the device. The rubber feet cushion the Switch, protect the casing from scratches and prevent it from scratching other surfaces.

Installing the Switch without the Rack

When installing the Switch on a desktop or shelf, the rubber feet included with the Switch should first be attached. Attach these cushioning feet on the bottom at each corner of the device. Allow enough ventilation space between the Switch and any other objects in the vicinity.

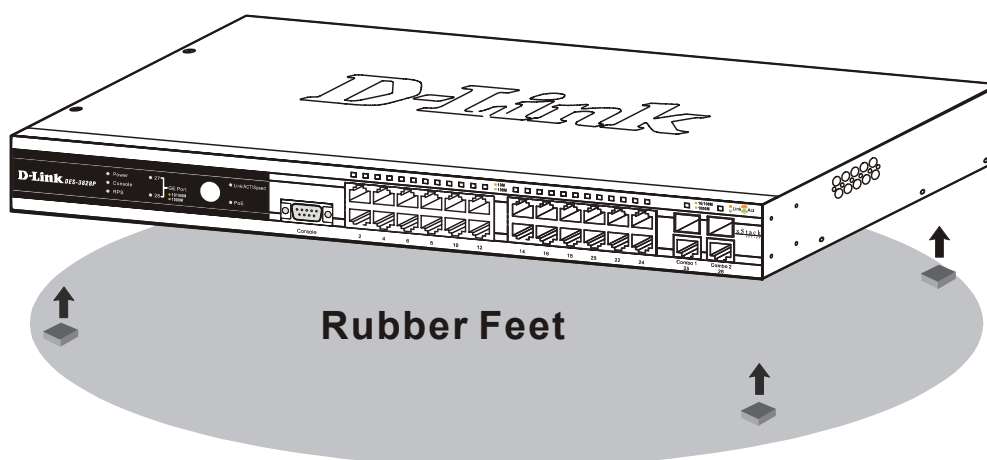

Figure 2 - 1. Prepare Switch for installation on a desktop or shelf

Installing the Switch in a Rack

The Switch can be mounted in a standard 19" rack. Use the following diagrams to guide you.

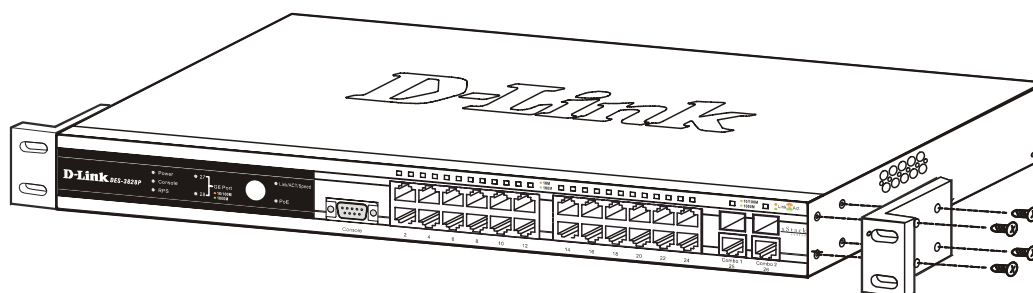

Figure 2 - 2. Fasten mounting brackets to Switch

Fasten the mounting brackets to the Switch using the screws provided. With the brackets attached securely, you can mount the Switch in a standard rack as shown in Figure 2-3 below.

Mounting the Switch in a Standard 19" Rack



CAUTION: Installing systems in a rack without the front and side stabilizers installed could cause the rack to tip over, potentially resulting in bodily injury under certain circumstances. Therefore, always install the stabilizers before installing components in the rack. After installing components in a rack, do not pull more than one component out of the rack on its slide assemblies at one time. The weight of more than one extended component could cause the rack to tip over and may result in injury.

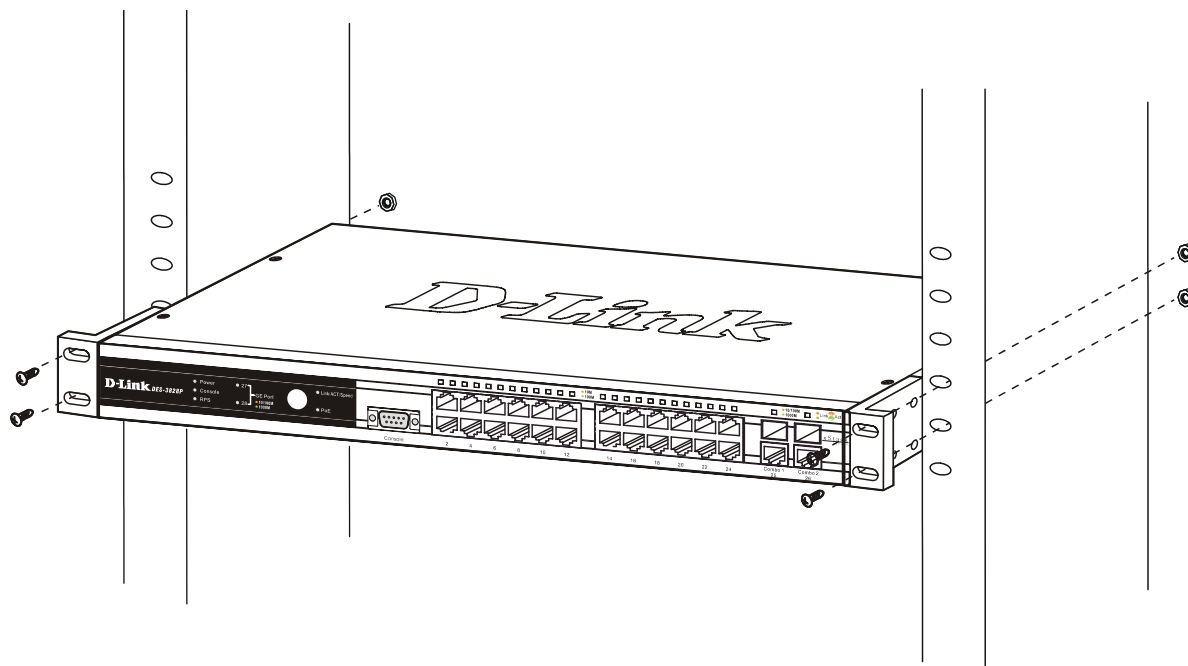

Figure 2 - 3. Installing Switch in a rack

Power on AC Power

Plug one end of the AC power cord into the power connector of the Switch and the other end into the local power source outlet.

After the Switch is powered on, the LED indicators will momentarily blink. This blinking of the LED indicators represents a reset of the system.

Power Failure

For AC power supply units, as a precaution, in the event of a power failure, unplug the Switch. When power has resumed, plug the Switch back in.

Connecting DC Power to the DES-3828DC

Follow the instructions below to connect the DC power supply of the DES-3828DC to the DC power source.



Figure 2 - 4. Power connections attached to contacts after assembly

1. Firmly attach the DC power to the negative and positive contacts on the wiring assembly.
 - The negative pole (-) connects to the **-48V** contact.
 - The positive pole (+) connects to the **-48V Return** contact.
 - If available, an earth ground may be connected to the center contact post.
2. Tighten the contact screws to secure the connection.

RPS Installation

Follow the instructions below to connect an RPS power supply to the Switch (DPS-200 to DES-3828/DES-3852 or DPS-600 to DES-3828P). The DPS-200 is a redundant power-supply unit designed to conform to the voltage requirements of the switches being supported. DPS-200 can be installed into DPS-900, or DPS-800.



CAUTION: The AC power cord for the Switch should be disconnected before proceeding with installation of the DPS-200.

DPS-900

The DPS-900 is a standard-size rack mount (5 standard units in height) designed to hold up to eight DPS-200 redundant power supplies.

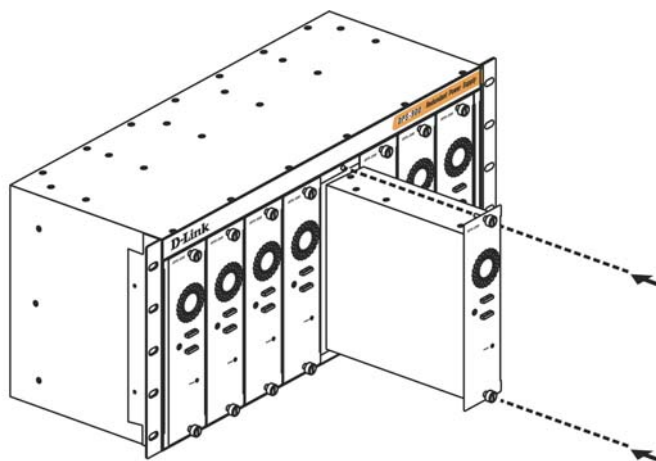

Figure 2 - 5. Installing the DPS-200 into the DPS-900

The RPS can be mounted in a standard 19" rack. Use the following diagram to guide you.

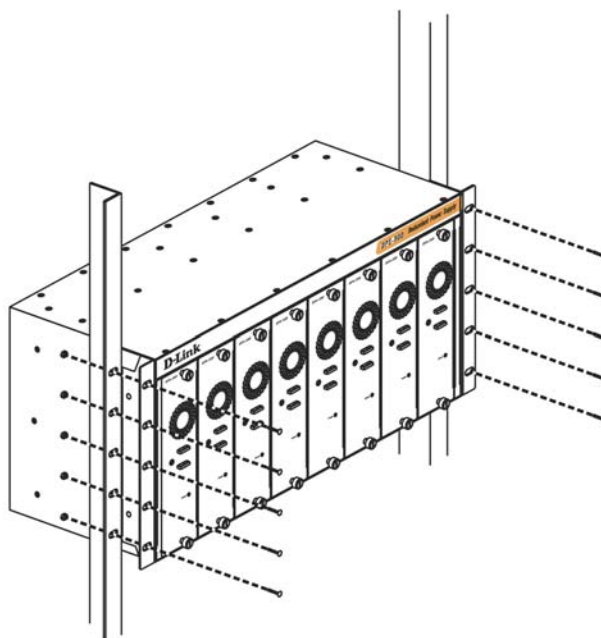

Figure 2 - 6. Installing the DPS-900 into the equipment rack



CAUTION: Installing systems in a rack without the front and side stabilizers installed could cause the rack to tip over, potentially resulting in bodily injury under certain circumstances. Therefore, always install the stabilizers before installing components in the rack. After installing components in a rack, do not pull more than one component out of the rack on its slide assemblies at one time. The weight of more than one extended component could cause the rack to tip over and may result in injury.

DPS-800

The DPS-800 is a standard-size rack mount (1 standard unit in height) designed to hold up to two DPS-200 redundant power supplies.

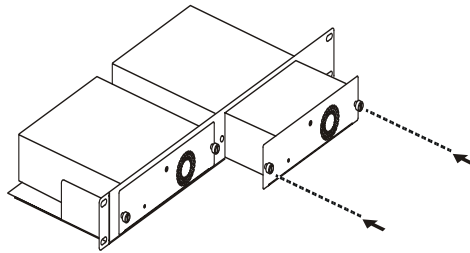

Figure 2 - 7. Install DPS-200 in DPS-800

The RPS can be mounted in a standard 19" rack. Use the following diagram to guide you.

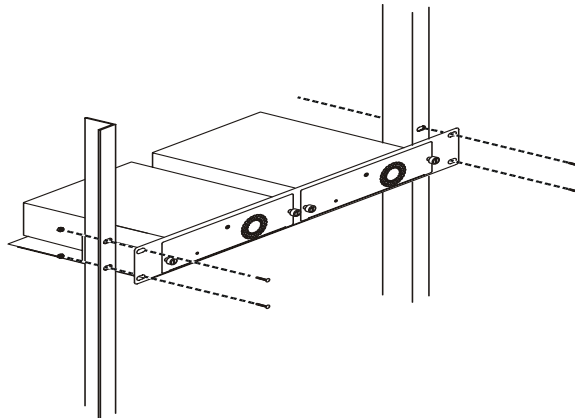

Figure 2 - 8. Install DPS-800 in an Equipment Rack

Connect to RPS

The DPS-200 is connected to the Master Switch using a 14-pin DC power cable. A standard, three-pronged AC power cable connects the redundant power supply to the main power source.

DES-3828/3852

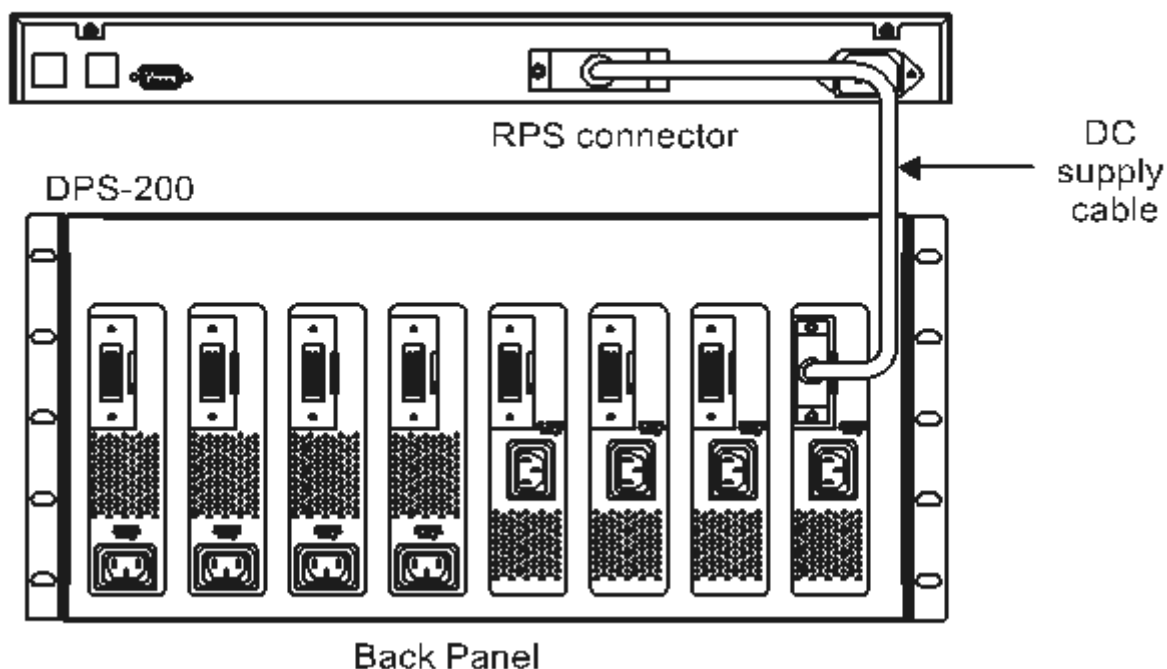

Figure 2 - 9. The DES-3828 with the DPS-200 chassis RPS

1. Insert one end of the 14-pin DC power cable into the receptacle on the switch and the other end into the redundant power supply.
2. Using a standard AC power cable, connect the redundant power supply to the main AC power source. A green LED on the front of the DPS-200 will glow to indicate a successful connection.
3. Re-connect the switch to the AC power source. On certain switches, such as the DES-3828, an LED indicator will show that a redundant power supply is now in operation.
4. No change in switch configuration is necessary for this installation.



NOTE: See the DPS-200 documentation for more information.



CAUTION: Do not use the Switch with any redundant power system other than the DPS-200 or DPS 600.

DPS-600

DES-3828P also supports the DPS-600 external redundant power supply.

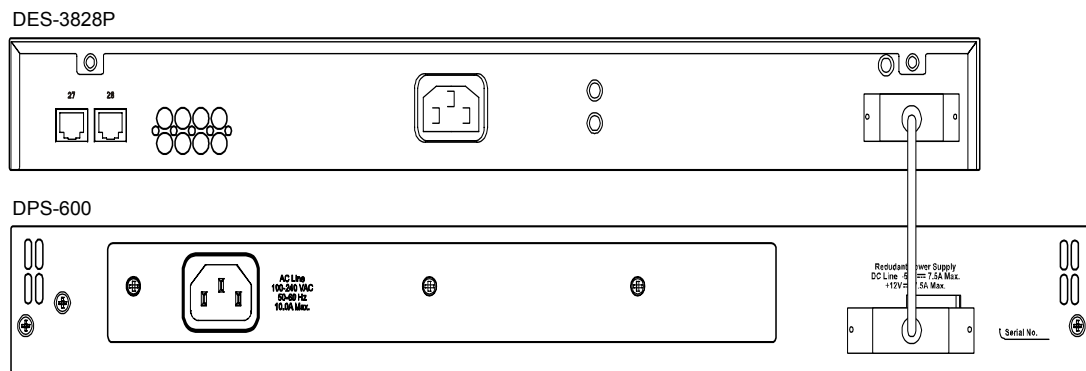

Figure 2 - 10. DES-3828P with the DPS-600 External Redundant Power Supply

Section 3

Connecting the Switch

Switch to End Node

Switch to Hub or Switch

Connecting to Network Backbone or Server



NOTE: All 24 high-performance NWay Ethernet ports can support both MDI-II and MDI-X connections.

Switch to End Node

End nodes include PCs outfitted with a 10, 100 or 1000 Mbps RJ 45 Ethernet/Fast Ethernet Network Interface Card (NIC) and most routers. An end node can be connected to the Switch via a twisted-pair Category 3, 4, or 5 UTP/STP cable. The end node should be connected to any of the ports of the Switch.

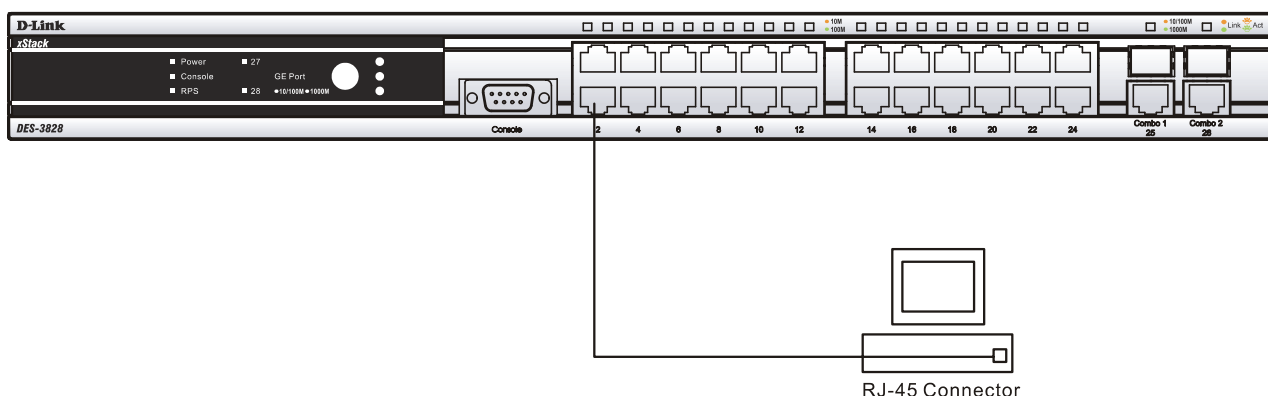

Figure 3- 1. Switch connected to an end node

The Link/Act LEDs for each UTP port will light green or amber when the link is valid. A blinking LED indicates packet activity on that port.

Switch to Hub or Switch

These connections can be accomplished in a number of ways using a normal cable.

- A 10BASE-T hub or switch can be connected to the Switch via a twisted-pair Category 3, 4 or 5 UTP/STP cable.
- A 100BASE-TX hub or switch can be connected to the Switch via a twisted-pair Category 5 UTP/STP cable.
- A 1000BASE-T switch can be connected to the Switch via a twisted pair Category 5e UTP/STP cable.
- A switch supporting a fiber-optic uplink can be connected to the Switch's SFP ports via fiber-optic cabling.
- The Switch can be changed to PoE mode using the Mode Select button. When in PoE Mode, the DES-3828P will work with all D-Link 802.3af capable devices. The Switch also works in PoE mode with all non-802.3af capable D-Link AP, IP Cam and IP phone equipment via DWL-P50.

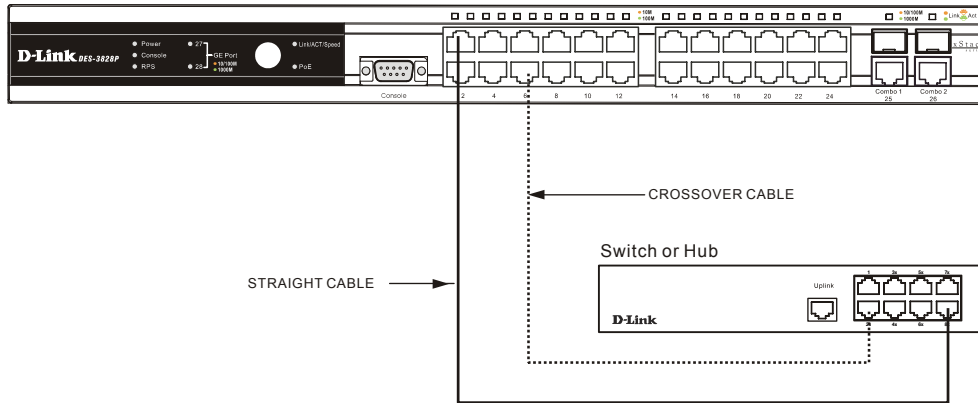

Figure 3- 2. Switch connected to a normal (non-Uplink) port on a hub or switch using a straight or crossover cable



NOTICE: When the SFP transceiver acquires a link, the associated integrated 10/100/1000BASE-T port is disabled.

Connecting To Network Backbone or Server

The two Mini-GBIC combo ports are ideal for unlinking to a network backbone or server. The copper ports operate at a speed of 1000, 100 or 10Mbps in full duplex mode. The fiber optic ports can operate at 1000Mbps in full duplex mode. Connections to the Gigabit Ethernet ports are made using fiber optic cable or Category 5 copper cable, depending on the type of port. A valid connection is indicated when the Link LED is lit.

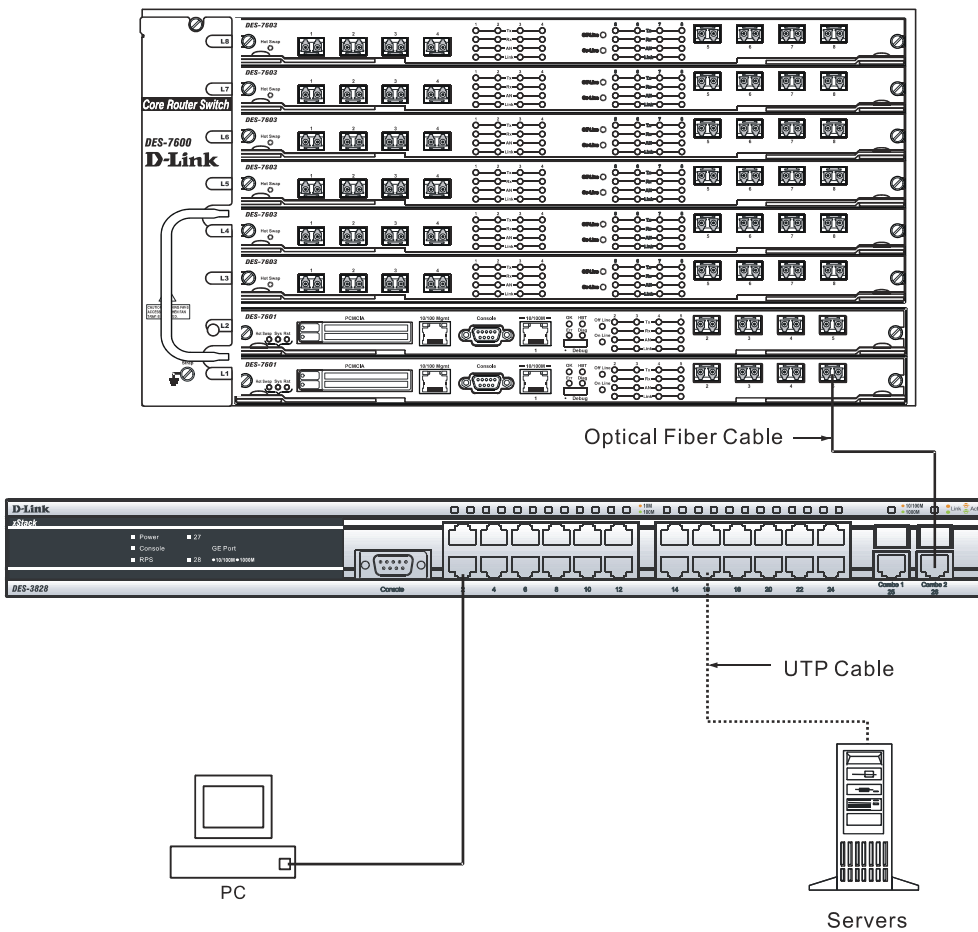

Figure 3- 3. Uplink Connection to a server, PC or switch stack.

Section 4

Introduction to Switch Management

Management Options

Web-based Management Interface

SNMP-Based Management

Managing User Accounts

Command Line Console Interface through the Serial Port

Connecting the Console Port (RS-232 DCE)

First Time Connecting to the Switch

Password Protection

SNMP Settings

IP Address Assignment

Management Options

This system may be managed out-of-band through the console port on the front panel or in-band using Telnet. The user may also choose the web-based management, accessible through a web browser.

Web-based Management Interface

After you have successfully installed the Switch, you can configure the Switch, monitor the LED panel, and display statistics graphically using a web browser, such as Netscape Navigator (version 6.2 and higher) or Microsoft® Internet Explorer (version 5.0).

SNMP-Based Management

You can manage the Switch with an SNMP-compatible console program. The Switch supports SNMP version 1.0, version 2.0 and version 3.0. The SNMP agent decodes the incoming SNMP messages and responds to requests with MIB objects stored in the database. The SNMP agent updates the MIB objects to generate statistics and counters.

Connecting the Console Port (RS-232 DCE)

The Switch provides an RS-232 serial port that enables a connection to a computer or terminal for monitoring and configuring the Switch. This port is a female DB-9 connector, implemented as a data terminal equipment (DTE) connection.

To use the console port, you need the following equipment:

- A terminal or a computer with both a serial port and the ability to emulate a terminal.
- A null modem or crossover RS-232 cable with a female DB-9 connector for the console port on the Switch.

To connect a terminal to the console port:

1. Connect the female connector of the RS-232 cable directly to the console port on the Switch, and tighten the captive retaining screws.
2. Connect the other end of the cable to a terminal or to the serial connector of a computer running terminal emulation software. Set the terminal emulation software as follows:
3. Select the appropriate serial port (COM port 1 or COM port 2).
4. Set the data rate to 9600 baud.
5. Set the data format to 8 data bits, 1 stop bit, and no parity.
6. Set flow control to none.

7. Under Properties, select VT100 for Emulation mode.
8. Select Terminal keys for Function, Arrow, and Ctrl keys. Ensure that you select Terminal keys (not Windows keys).



NOTE: When you use HyperTerminal with the Microsoft® Windows® 2000 operating system, ensure that you have Windows 2000 Service Pack 2 or later installed. Windows 2000 Service Pack 2 allows you to use arrow keys in HyperTerminal's VT100 emulation. See www.microsoft.com for information on Windows 2000 service packs.

9. After you have correctly set up the terminal, plug the power cable into the power receptacle on the back of the Switch. The boot sequence appears in the terminal.
10. After the boot sequence completes, the console login screen displays.
11. If you have not logged into the command line interface (CLI) program, press the Enter key at the User name and password prompts. There is no default user name and password for the Switch. The administrator must first create user names and passwords. If you have previously set up user accounts, log in and continue to configure the Switch.
12. Enter the commands to complete your desired tasks. Many commands require administrator-level access privileges. Read the next section for more information on setting up user accounts. See the *xStack DES-3800 Series CLI Manual* on the documentation CD for a list of all commands and additional information on using the CLI.
13. When you have completed your tasks, exit the session with the logout command or close the emulator program.
14. Make sure the terminal or PC you are using to make this connection is configured to match these settings.

If you are having problems making this connection on a PC, make sure the emulation is set to VT-100. You will be able to set the emulation by clicking on the **File** menu in your HyperTerminal window, clicking on **Properties** in the drop-down menu, and then clicking the **Settings** tab. This is where you will find the **Emulation** options. If you still do not see anything, try rebooting the Switch by disconnecting its power supply.

Once connected to the console, the screen below will appear on your console screen. This is where the user will enter commands to perform all the available management functions. The Switch will prompt the user to enter a user name and a password. Upon the initial connection, there is no user name or password and therefore just press enter twice to access the command line interface.

```
DES-3828P PoE Fast Ethernet Switch Command Line Interface
                          Firmware: Build 2.00.B30
                          Copyright(C) 2004-2005 D-Link Corporation. All rights reserved.
UserName:
```

Figure 4- 1. Initial screen after first connection

First Time Connecting to the Switch

The Switch supports user-based security that can allow you to prevent unauthorized users from accessing the Switch or changing its settings. This section tells how to log onto the Switch.



NOTE: The passwords used to access the Switch are case-sensitive; therefore, "S" is not the same as "s."

When you first connect to the Switch, you will be presented with the first login screen.



NOTE: Press Ctrl+R to refresh the screen. This command can be used at any time to force the console program in the Switch to refresh the console screen.

Press Enter in both the Username and Password fields. You will be given access to the command prompt **DES-3828:4#** shown below:

There is no initial username or password. Leave the Username and Password fields blank.

```

DES-3828P PoE Fast Ethernet Switch Command Line Interface
                          Firmware: Build 2.00.B30
Copyright(C) 2004-2005 D-Link Corporation. All rights reserved.
UserName:

```

Figure 4- 2. Command Prompt



NOTE: The first user automatically gets Administrator level privileges. It is recommended to create at least one Admin-level user account for the Switch.

Password Protection

The Switch does not have a default user name and password. One of the first tasks when settings up the Switch is to create user accounts. If you log in using a predefined administrator-level user name, you have privileged access to the Switch's management software.

After your initial login, define new passwords for both default user names to prevent unauthorized access to the Switch, and record the passwords for future reference.

To create an administrator-level account for the Switch, follow these steps:

- At the CLI login prompt, enter **create account admin** followed by the *<user name>* and press the Enter key.
- You will be asked to provide a password. Type the *<password>* used for the administrator account being created and press the Enter key.

- You will be prompted to enter the same password again to verify it. Type the same password and press the Enter key.
- Successful creation of the new administrator account will be verified by a Success message.



NOTE: Passwords are case sensitive. User names and passwords can be up to 15 characters in length.

The sample below illustrates a successful creation of a new administrator-level account with the user name "newmanager".

```
DES-3800:4#create account admin newmanager
Command: create account admin newmanager

Enter a case-sensitive new password:*****
Enter the new password again for confirmation:*****

Success.

DES-3800:4#
```



NOTICE: CLI configuration commands only modify the running configuration file and are not saved when the Switch is rebooted. To save all your configuration changes in nonvolatile storage, you must use the save command to copy the running configuration file to the startup configuration.

SNMP Settings

Simple Network Management Protocol (SNMP) is an OSI Layer 7 (Application Layer) designed specifically for managing and monitoring network devices. SNMP enables network management stations to read and modify the settings of gateways, routers, switches, and other network devices. Use SNMP to configure system features for proper operation, monitor performance and detect potential problems in the Switch, switch group or network.

Managed devices that support SNMP include software (referred to as an agent), which runs locally on the device. A defined set of variables (managed objects) is maintained by the SNMP agent and used to manage the device. These objects are defined in a Management Information Base (MIB), which provides a standard presentation of the information controlled by the on-board SNMP agent. SNMP defines both the format of the MIB specifications and the protocol used to access this information over the network.

The DES-3800 Series supports SNMP versions 1, 2c, and 3. You can specify which version of SNMP you want to use to monitor and control the Switch. The three versions of SNMP vary in the level of security provided between the management station and the network device.

In SNMP v.1 and v.2, user authentication is accomplished using 'community strings', which function like passwords. The remote user SNMP application and the Switch SNMP must use the same community string. SNMP packets from any station that has not been authenticated are ignored (dropped).

The default community strings for the Switch used for SNMP v.1 and v.2 management access are:

- public - Allows authorized management stations to retrieve MIB objects.
- private - Allows authorized management stations to retrieve and modify MIB objects.

SNMP v.3 uses a more sophisticated authentication process that is separated into two parts. The first part is to maintain a list of users and their attributes that are allowed to act as SNMP managers. The second part describes what each user on that list can do as an SNMP manager.

The Switch allows groups of users to be listed and configured with a shared set of privileges. The SNMP version may also be set for a listed group of SNMP managers. Thus, you may create a group of SNMP managers that are allowed to view read-only

information or receive traps using SNMP v.1 while assigning a higher level of security to another group, granting read/write privileges using SNMP v.3.

Using SNMP v.3 individual users or groups of SNMP managers can be allowed to perform or be restricted from performing specific SNMP management functions. The functions allowed or restricted are defined using the Object Identifier (OID) associated with a specific MIB. An additional layer of security is available for SNMP v.3 in that SNMP messages may be encrypted. To read more about how to configure SNMP v.3 settings for the Switch read the section entitled Management.

Traps

Traps are messages that alert network personnel of events that occur on the Switch. The events can be as serious as a reboot (someone accidentally turned OFF the Switch), or less serious like a port status change. The Switch generates traps and sends them to the trap recipient (or network manager). Typical traps include trap messages for Authentication Failure, Topology Change and Broadcast/Multicast Storm.

MIBs

The Switch in the Management Information Base (MIB) stores management and counter information. The Switch uses the standard MIB-II Management Information Base module. Consequently, values for MIB objects can be retrieved from any SNMP-based network management software. In addition to the standard MIB-II, the Switch also supports its own proprietary enterprise MIB as an extended Management Information Base. Specifying the MIB Object Identifier may also retrieve the proprietary MIB. MIB values can be either read-only or read-write.

IP Address Assignment

Each Switch must be assigned its own IP Address, which is used for communication with an SNMP network manager or other TCP/IP application (for example BOOTP, TFTP). The Switch's default IP address is 10.90.90.90. You can change the default Switch IP address to meet the specification of your networking address scheme.

The Switch is also assigned a unique MAC address by the factory. This MAC address cannot be changed, and can be found by entering the command "show switch" into the command line interface, as shown below.

```

Device Type       : DES-3828P PoE Fast-Ethernet Switch
Combo Port Type  : 1000Base-T + 1000Base-T
MAC Address       : 00-01-02-03-04-00
IP Address        : 10.53.13.52 (Manual)
VLAN Name         : default
Subnet Mask       : 255.0.0.0
Default Gateway   : 0.0.0.0
Boot PROM Version : Build 0.00.008
Firmware Version  : Build 2.00.B30
Hardware Version  :
Device S/N        :
Power Status      : Main - Normal, Redundant - Not Present
System Name       :
System Location   :
System Contact    :
Spanning Tree     : Disabled
GVRP              : Disabled
IGMP Snooping     : Disabled
TELNET            : Enabled (TCP 2323)
SSH               : Disabled
WEB               : Enabled (TCP 80)
RMON              : Disabled
CTRL+C ESC q Quit SPACE n Next Page ENTER Next Entry a All

```

Figure 4- 3. Show switch command

The Switch's MAC address can also be found from the Web management program on the **Switch Information (Basic Settings)** window on the **Configuration** menu.

The IP address for the Switch must be set before it can be managed with the Web-based manager. The Switch IP address can be automatically set using BOOTP or DHCP protocols, in which case the actual address assigned to the Switch must be known.

The IP address may be set using the Command Line Interface (CLI) over the console serial port as follows:

Starting at the command line prompt, enter the commands

```
config ipif System ipaddress xxx.xxx.xxx.xxx/yyy.yyy.yyy.yyy
```

Where the x's represent the IP address to be assigned to the IP interface named System and the y's represent the corresponding subnet mask.

Alternatively, you can enter **config ipif System ipaddress xxx.xxx.xxx.xxx/z**. Where the x's represent the IP address to be assigned to the IP interface named System and the z represents the corresponding number of subnets in CIDR notation.

The IP interface named System on the Switch can be assigned an IP address and subnet mask, and then be used to connect a management station to the Switch's Telnet or Web-based management agent.

```
DES-3800:4#config ipif System ipaddress 10.53.13.52/255.0.0.0
Command: config ipif System ipaddress 10.53.13.52/8

Success.
DES-3800:4#
```

Figure 4- 4. Assigning the Switch an IP Address

In the above example, the Switch was assigned an IP address of 10.53.13.52 with a subnet mask of 255.0.0.0. The user may also use the CIDR form to set the address (10.53.13.52/8). The system message **Success** indicates that the command was executed successfully. The Switch can now be configured and managed via Telnet and the CLI or via the Web-based management.

Section 5

Web-based Switch Configuration

Introduction

Login to Web manager

Web-Based User Interface

Basic Setup

Reboot

Basic Switch Setup

Network Management

Switch Utilities

Network Monitoring

IGMP Snooping Status

Introduction

All software functions of the Switch can be managed, configured and monitored via the embedded web-based (HTML) interface. The Switch can be managed from remote stations anywhere on the network through a standard browser such as Opera, Netscape Navigator/Communicator, or Microsoft Internet Explorer. The browser acts as a universal access tool and can communicate directly with the Switch using the HTTP protocol.

The Web-based management module and the Console program (and Telnet) are different ways to access the same internal switching software and configure it. Thus, all settings encountered in web-based management are the same as those found in the console program.

Login to Web Manager

To begin managing your Switch, simply run the browser you have installed on your computer and point it to the IP address you have defined for the device. The URL in the address bar should read something like: `http://123.123.123.123`, where the numbers 123 represent the IP address of the Switch.



NOTE: The Factory default IP address for the Switch is 10.90.90.90.

This opens the management module's user authentication window, as seen below.



Figure 5- 1. Enter Network Password window

Leave both the User Name field and the Password field blank and click **OK**. This will open the Web-based user interface. The Switch management features available in the web-based manager are explained below.

Web-based User Interface

The user interface provides access to various Switch configuration and management screens, allows you to view performance statistics, and permits you to graphically monitor the system status.

Areas of the User Interface

The figure below shows the user interface. The user interface is divided into three distinct areas as described in the table.

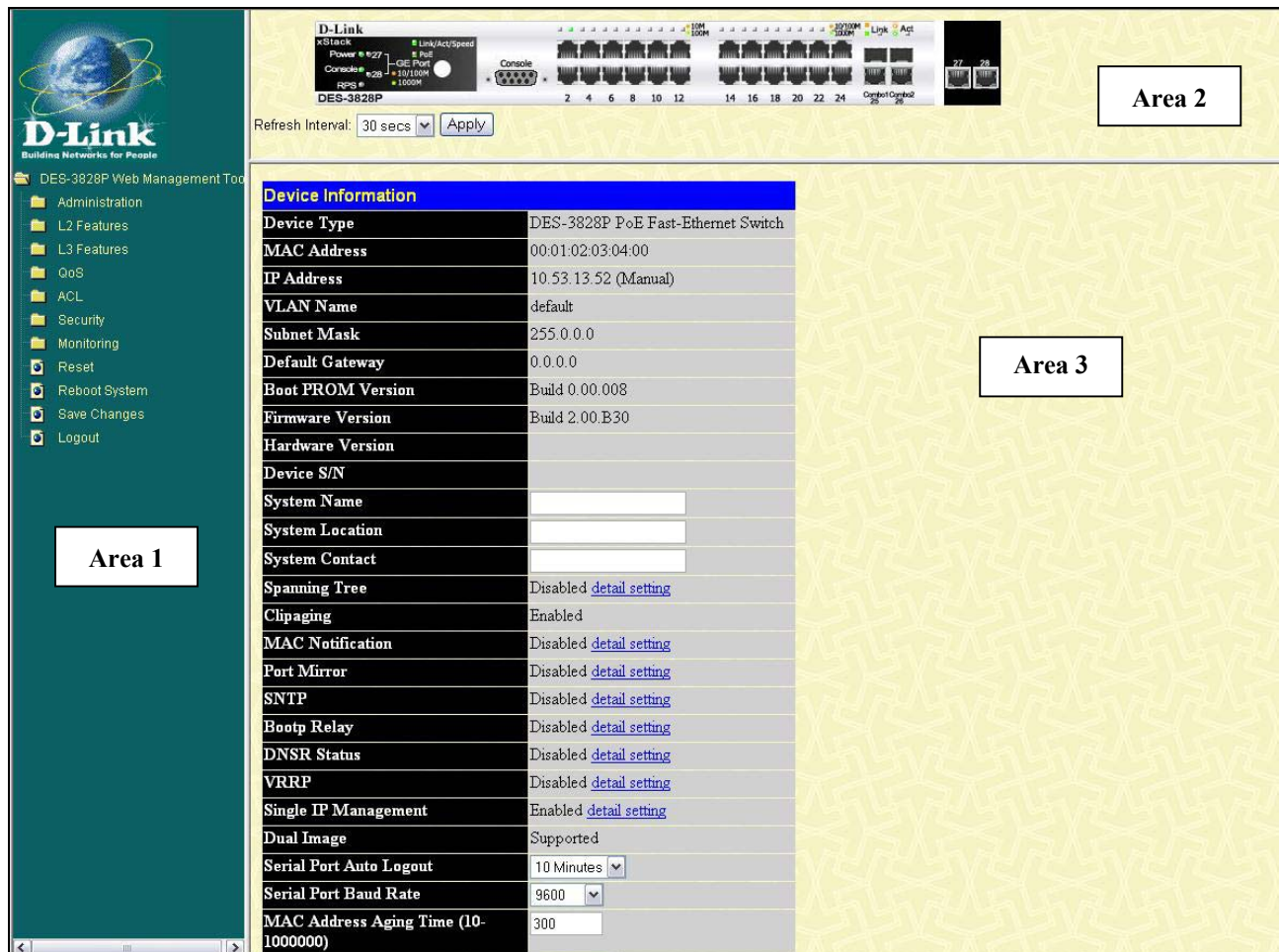

Figure 5- 2. Main Web-Manager page

Area	Function
Area 1	Select the menu or window to be displayed. The folder icons can be opened to display the hyper-linked menu buttons and subfolders contained within them. Click the D-Link logo to go to the D-Link website.
Area 2	Presents a graphical near real-time image of the front panel of the Switch. This area displays the Switch's ports and expansion modules, showing port activity, duplex mode, or flow control, depending on the specified mode. Various areas of the graphic can be selected for performing management functions, including port configuration.
Area 3	Presents switch information based on your selection and the entry of configuration data.



NOTICE: Any changes made to the Switch configuration during the current session must be saved in the Save Changes web menu (explained below) or use the command line interface (CLI) command save.

Web Pages

When you connect to the management mode of the Switch with a web browser, a login window is displayed. Enter a user name and password to access the Switch's management mode.

Below is a list and description of the main folders available in the web interface:

Administration – Contains windows concerning IP Address, Port Configuration, PoE Configuration (for the DES-3828), User Accounts, Port Mirroring, System Log Settings, System Severity Settings, SNTP Settings, MAC Notification Settings, TFTP Services, Multiple Image Services, Dual Configurations Services, Ping Test, SNMP Manager, and Single IP Management Settings

Layer 2 Features – Contains windows concerning VLAN, Trunking, IGMP Snooping, Spanning Tree, and Forwarding.

Layer 3 Features – Contains windows concerning IP Interfaces Settings, MD5 Key Settings, Route Redistribution Settings, Static/Default Route Settings, Route Preference Settings, Static ARP Settings, RIP, OSPF, DHCP/BOOTP Relay, DNS Relay, VRRP, and IP Multicast Routing Settings.

QoS – Contains windows concerning Bandwidth Control, QoS Scheduling Mechanism, QoS Output Scheduling, 802.1P Default Priority, 802.1P User Priority and WRED Settings.

ACL – Contains the window for the Access Profile Table and CPU Interface Filtering.

Security – Contains windows for Traffic Control, Port Security, Port Lock Entries, 802.1x, Trusted Host, Access Authentication Control, Traffic Segmentation, SSL, SSH, IP-MAC Binding, Limited IP Multicast Range, WAC Configuration and Safeguard Engine.

Monitoring – Contains windows for Device Status, CPU Utilization, Safeguard Engine Status, Port Utilization, Packets, Errors, Packet Size, Browse Router Port, Port Access Control, MAC Address Table, IP Address Table, Browse Routing Table, Browse ARP Table, Browse IP Multicast Forwarding Table, IGMP Snooping Group, IGMP Snooping Forwarding, Browse IGMP Group Table, DVMRP Monitor, OSPF Monitor, Browse PoE Status, Browse WRED Settings and Switch Log.



NOTE: Be sure to configure the user name and password in the User Accounts menu before connecting the Switch to the greater network.

Section 6

Administration

Device Information

IP Address

Port Configuration

PoE Configuration

User Accounts

Port Mirroring

System Log Settings

System Severity Settings

SNTP Settings

MAC Notification Settings

TFTP Services

Multiple Image Services

Dual Configurations Services

Ping Test

SNMP Manager

Single IP Management Setting

Device Information

The **Device Information** window contains the main settings for all major functions for the Switch and appears automatically when you log on. To return to the **Device Information** window, click the **DES-3800 Web Management Tool** folder. The Device Information window shows the Switch's **MAC Address** (assigned by the factory and unchangeable), the **Boot PROM**, **Firmware Version**, and **Hardware Version**. This information is helpful to keep track of PROM and firmware updates and to obtain the Switch's MAC address for entry into another network device's address table, if necessary. The user may also enter a **System Name**, **System Location** and **System Contact** to aid in defining the Switch, to the user's preference. In addition, this screen displays the status of functions on the Switch to quickly assess their current global status. Some Functions are hyper-linked to their configuration window for easy access from the Device Information window.

Device Information	
Device Type	DES-3828P PoE Fast-Ethernet Switch
MAC Address	00:01:02:03:04:00
IP Address	10.53.13.52 (Manual)
VLAN Name	default
Subnet Mask	255.0.0.0
Default Gateway	0.0.0.0
Boot PROM Version	Build 0.00.008
Firmware Version	Build 2.00.B30
Hardware Version	
Device S/N	
System Name	<input type="text"/>
System Location	<input type="text"/>
System Contact	<input type="text"/>
Spanning Tree	Disabled detail setting
Clipping	Enabled
MAC Notification	Disabled detail setting
Port Mirror	Disabled detail setting
SNTP	Disabled detail setting
Bootp Relay	Disabled detail setting
DNSR Status	Disabled detail setting
VRRP	Disabled detail setting
Single IP Management	Enabled detail setting
Dual Image	Supported
Serial Port Auto Logout	10 Minutes <input type="text"/>
Serial Port Baud Rate	9600 <input type="text"/>
MAC Address Aging Time (10-1000000)	300 <input type="text"/>
IGMP Snooping	Disabled <input type="text"/> detail setting
Multicast Router Only	Disabled <input type="text"/>
GVRP Status	Disabled <input type="text"/>
Telnet Status	Enabled <input type="text"/>
Telnet TCP Port Number (1-65535)	2323 <input type="text"/>
Web Status	Enabled (TCP 80)
SNMP Status	Disabled <input type="text"/>
RMON Status	Disabled <input type="text"/>
Link Aggregation Algorithm	IP Source <input type="text"/>
Switch 802.1x	Disabled <input type="text"/>
Auth Protocol	RADIUS Eap <input type="text"/>
Jumbo Frame	Disabled <input type="text"/>
Syslog State	Disabled <input type="text"/>
DVMRP State	Disabled <input type="text"/>
PIM-DM State	Disabled <input type="text"/>
RIP State	Disabled <input type="text"/>
OSPF State	Disabled <input type="text"/>
ARP Aging Time(0-65535)	40 <input type="text"/>
CPU Interface Filtering	Disabled <input type="text"/>

Figure 6- 1. Device Information window

The fields that can be configured are described below:

Parameter	Description
System Name	Enter a system name for the Switch, if so desired. This name will identify it in the Switch network.
System Location	Enter the location of the Switch, if so desired.
System Contact	Enter a contact name for the Switch, if so desired.
Dual Image	Displays the Dual Image support for the Switch, or the ability to store more than one firmware code on the Switch without implementation.
Serial Port Auto Logout Time	Select the logout time used for the console interface. This automatically logs the user out after an idle period of time, as defined. Choose from the following options: <i>2 Minutes</i> , <i>5 Minutes</i> , <i>10 Minutes</i> , <i>15 Minutes</i> or <i>Never</i> . The default setting is <i>10 minutes</i> .
Serial Baud Rate	This field specifies the baud rate for the serial port on the Switch. there are four possible baud rates to choose from, <i>9600</i> , <i>19200</i> , <i>38400</i> and <i>115200</i> . For a connection to the Switch using the CLI interface, the baud rate must be set to <i>9600</i> , which is the default setting.
MAC Address Aging Time	This field specifies the length of time a learned MAC Address will remain in the forwarding table without being accessed (that is, how long a learned MAC Address is allowed to remain idle). To change this, type in a different value representing the MAC address age-out time in seconds. The MAC Address Aging Time can be set to any value between <i>10</i> and <i>1,000,000</i> seconds. The default setting is <i>300</i> seconds.
IGMP Snooping	To enable system-wide IGMP Snooping capability select <i>Enabled</i> . IGMP snooping is <i>Disabled</i> by default. Enabling IGMP snooping allows you to specify use of a multicast router only (see below). To configure IGMP Snooping for individual VLANs, use the IGMP Snooping located in the IGMP Snooping folder contained in the L2 Features folder.
Multicast Router Only	This field specifies that the Switch should only forward all multicast traffic to a multicast-enabled router, if enabled. Otherwise, the Switch will forward all multicast traffic to any IP router. The default is <i>Disabled</i> .
GVRP Status	Use this pull-down menu to enable or disable GVRP on the Switch.
Telnet Status	Telnet configuration is <i>Enabled</i> by default. If you do not want to allow configuration of the system through Telnet choose <i>Disabled</i> .
Telnet TCP Port Number (1-65535)	The TCP port number. TCP ports are numbered between <i>1</i> and <i>65535</i> . The "well-known" TCP port for the Telnet protocol is <i>23</i> .
Web Status	Web-based management is <i>Enabled</i> by default. If you choose to disable this by selecting <i>Disabled</i> , you will lose the ability to configure the system through the web interface as soon as these settings are applied.
SNMP Status	Simple Network Monitoring Protocol (SNMP) of the Switch is <i>Enabled</i> or <i>Disabled</i> here. The Default is <i>Disabled</i> .
RMON Status	Remote monitoring (RMON) of the Switch is <i>Enabled</i> or <i>Disabled</i> here.
Link Aggregation Algorithm	The algorithm that the Switch uses to balance the load across the ports that make up the port trunk group is defined by this definition. Choose <i>MAC Source</i> , <i>MAC Destination</i> , <i>MAC Src & Dest</i> , <i>IP Source</i> , <i>IP Destination</i> or <i>IP Src & Dest</i> (See the Link Aggregation section of this manual).
802.1x Status	<p>MAC Address may enable by port or the Switch's 802.1x function; the default is <i>Disabled</i>. This field must be enabled to view and configure certain windows for 802.1x. More information regarding 802.1x, its functions and implementation can be found later in this section, under the Port Access Entity folder.</p> <p>Port-Based 802.1x specifies that ports configured for 802.1x are initialized based on the port number only and are subject to any authorization parameters configured.</p> <p>MAC-based Authorization specifies that ports configured for 802.1x are initialized based on the port number and the MAC address of the computer being authorized and are then subject to any authorization parameters configured.</p>

Auth Protocol	The 802.1x authentication protocol on the Switch is set to RADIUS Eap and cannot be altered.
Jumbo Frame	This field will enable or disable the Jumbo Frame function on the Switch. The default is Disabled. When enabled, jumbo frames (frames larger than the standard Ethernet frame size of 1518 bytes) of up to 9K (and 9004 bytes tagged) can be transmitted by the Switch.
Syslog State	Enables or disables Syslog State; default is <i>Disabled</i> .
DVMRP State	The user may globally enable or disable the Distance Vector Multicast Routing Protocol (DVMRP) function by using the pull down menu.
PIM-DM State	The user may globally enable or disable the Protocol Independent Multicast - Dense Mode (PIM-DM) function by using the pull down menu.
RIP State	The user may globally enable or disable the Routing Information Protocol (RIP) function by using the pull down menu.
OSPF State	The user may globally enable or disable the Open Shortest Path first (OSPF) function by using the pull down menu.
ARP Aging Time (0-65535)	The user may globally set the maximum amount of time, in minutes, that an Address Resolution Protocol (ARP) entry can remain in the Switch's ARP table, without being accessed, before it is dropped from the table. The value may be set in the range of 0-65535 minutes with a default setting of 20 minutes.
CPU Interface Filtering	The user may globally enable or disable the CPU Interface Filtering function by using the pull down menu.

Click **Apply** to implement changes made.

IP Address

The IP Address may initially be set using the console interface prior to connecting to it through the Ethernet. If the Switch IP address has not yet been changed, read the introduction of the *xStack DES-3800 Series CLI Manual* or return to Section 4 of this manual for more information. To change IP settings using the web manager you must access the IP Address menu located in the Administration folder.

To configure the Switch's IP address:

Open the **Administration** folder and click the **IP Address** menu link. The web manager will display the Switch's current IP settings in the IP configuration menu, as seen below.

Figure 6- 2. IP Address Settings window

To manually assign the Switch's IP address, subnet mask, and default gateway address:

1. Select *Manual* from the Get IP From drop-down menu.
2. Enter the appropriate IP Address and Subnet Mask.
3. If you want to access the Switch from a different subnet from the one it is installed on, enter the IP address of the Default Gateway. If you will manage the Switch from the subnet on which it is installed, you can leave the default address (0.0.0.0) in this field.
4. If no VLANs have been previously configured on the Switch, you can use the *default* VLAN Name. The *default VLAN* contains all of the Switch ports as members. If VLANs have been previously configured on the Switch, you will need to

enter the *VLAN ID* of the VLAN that contains the port connected to the management station that will access the Switch. The Switch will allow management access from stations with the same VID listed here.



NOTE: The Switch's factory default IP address is 10.90.90.90 with a subnet mask of 255.0.0.0 and a default gateway of 0.0.0.0.

To use the BOOTP or DHCP protocols to assign the Switch an IP address, subnet mask, and default gateway address:

Use the Get IP From pull-down menu to choose from *BOOTP* or *DHCP*. This selects how the Switch will be assigned an IP address on the next reboot.



NOTE: If you enable the **AutoConfig**, the **Get IP From** setting will automatically become DHCP.

The IP Address Settings options are:

Parameter	Description
BOOTP	The Switch will send out a BOOTP broadcast request when it is powered up. The BOOTP protocol allows IP addresses, network masks, and default gateways to be assigned by a central BOOTP server. If this option is set, the Switch will first look for a BOOTP server to provide it with this information before using the default or previously entered settings.
DHCP	The Switch will send out a DHCP broadcast request when it is powered up. The DHCP protocol allows IP addresses, network masks, and default gateways to be assigned by a DHCP server. If this option is set, the Switch will first look for a DHCP server to provide it with this information before using the default or previously entered settings.
Manual	Allows the entry of an IP address, Subnet Mask, and a Default Gateway for the Switch. These fields should be of the form xxx.xxx.xxx.xxx, where each xxx is a number (represented in decimal form) between 0 and 255. This address should be a unique address on the network assigned for use by the network administrator.
Subnet Mask	A Bitmask that determines the extent of the subnet that the Switch is on. Should be of the form xxx.xxx.xxx.xxx, where each xxx is a number (represented in decimal) between 0 and 255. The value should be 255.0.0.0 for a Class A network, 255.255.0.0 for a Class B network, and 255.255.255.0 for a Class C network, but custom subnet masks are allowed.
Default Gateway	IP address that determines where packets with a destination address outside the current subnet should be sent. This is usually the address of a router or a host acting as an IP gateway. If your network is not part of an intranet, or you do not want the Switch to be accessible outside your local network, you can leave this field unchanged.
VLAN Name	This allows the entry of a VLAN Name from which a management station will be allowed to manage the Switch using TCP/IP (in-band via web manager or Telnet). Management stations that are on VLANs other than the one entered here will not be able to manage the Switch in-band unless their IP addresses are entered in the Security IP Management menu. If VLANs have not yet been configured for the Switch, the default VLAN contains all of the Switch's ports. There are no entries in the Security IP Management table, by default, so any management station that can connect to the Switch can access the Switch until a management VLAN is specified or Management Station IP Addresses are assigned.
Auto Config State	When autoconfig is enabled, the Switch is instructed to get a configuration file via TFTP, and it becomes a DHCP client automatically. The configuration file will be loaded upon booting up. In order to use Auto Config, the DHCP server must be set up to deliver the TFTP server IP address and configuration file name information in the DHCP reply packet. The TFTP server must be running and have the requested configuration file stored in its base directory when the request is received from the Switch. Consult the DHCP server and/or TFTP server software instructions for information on loading a configuration file for use by a client. If the Switch is unable to complete the autoconfiguration process the previously saved configuration file present in Switch memory will be loaded.

Click **Apply** to let your changes take effect.

Setting the Switch's IP Address using the Console Interface

Each Switch must be assigned its own IP Address, which is used for communication with an SNMP network manager or other TCP/IP application (for example BOOTP, TFTP). The Switch's default IP address is 10.90.90.90. You can change the default Switch IP address to meet the specification of your networking address scheme.

The IP address for the Switch must be set before it can be managed with the Web-based manager. The Switch IP address can be automatically set using BOOTP or DHCP protocols, in which case the actual address assigned to the Switch must be known. The IP address may be set using the Command Line Interface (CLI) over the console serial port as follows:

Starting at the command line prompt, enter the commands **config ipif System ipaddress xxx.xxx.xxx.xxx/yyy.yyy.yyy.yyy**. Where the x's represent the IP address to be assigned to the IP interface named System and the y's represent the corresponding subnet mask.

Alternatively, you can enter **config ipif System ipaddress xxx.xxx.xxx.xxx/z**. Where the x's represent the IP address to be assigned to the IP interface named System and the z represents the corresponding number of subnets in CIDR notation.

The IP interface named System on the Switch can be assigned an IP address and subnet mask, which can then be used to connect a management station to the Switch's Telnet or Web-based management agent.

The system message **Success** indicates that the command was executed successfully. The Switch can now be configured and managed via Telnet and the CLI or via the Web-based management agent using the above IP address to connect to the Switch.

Port Configuration

This section contains information for configuring various attributes and properties for individual physical ports, including port speed and flow control.

Port Settings

Click **Administration > Port Configuration > Port Settings** to display the following window:

To configure switch ports:

1. Choose the port or sequential range of ports using the From...To... port pull-down menus.
2. Use the remaining pull-down menus to configure the parameters described below:

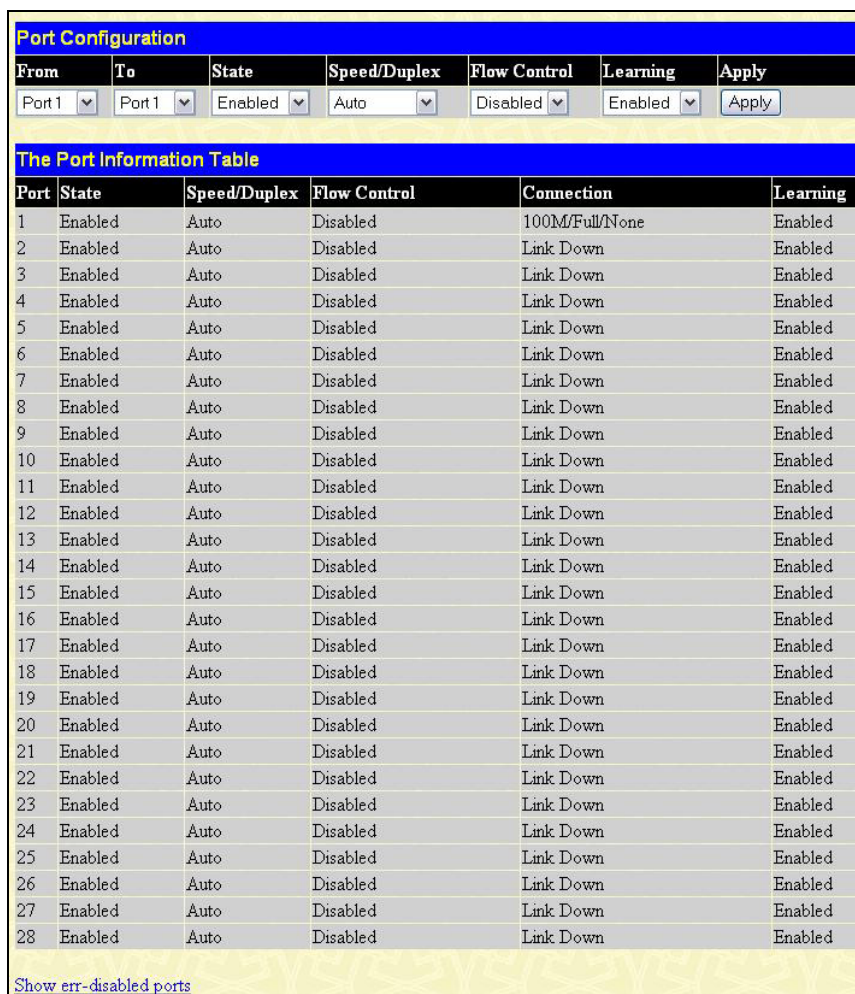

Figure 6- 3. Port Configuration window

The following parameters can be configured:

Parameter	Description
From.... To	Use the pull-down menus to select the port or range of ports to be configured.
State	Toggle this field to either enable or disable a given port or group of ports.
Speed/Duplex	Toggle the Speed/Duplex field to either select the speed and duplex/half-duplex state of the port. <i>Auto</i> denotes auto-negotiation between 10 and 100 Mbps devices, in full- or half-duplex. The <i>Auto</i> setting allows the port to automatically determine the fastest settings the device the port is connected to can handle, and then to use those settings. The other options are <i>Auto</i> , <i>10M/Half</i> , <i>10M/Full</i> , <i>100M/Half</i> , <i>100M/Full</i> and <i>1000M/Full</i> . There is no automatic adjustment of port settings with any option other than <i>Auto</i> .
Flow Control	Displays the flow control scheme used for the various port configurations. Ports configured for full-duplex use 802.3x flow control, half-duplex ports use backpressure flow control, and <i>Auto</i> ports use an automatic selection of the two. The default is <i>Disabled</i> .
Learning	Enable or disable MAC address learning for the selected ports. When <i>Enabled</i> , destination and source MAC addresses are automatically listed in the forwarding table. When learning is <i>Disabled</i> , MAC addresses must be manually entered into the forwarding table. This is sometimes done for security or efficiency. See the section on Forwarding/Filtering for information on entering MAC addresses into the forwarding table. The default setting is <i>Disabled</i> .

Click **Apply** to implement the new settings on the Switch.

At the bottom of the Port Configuration window is a [Show err-disabled ports](#) link to display the information about ports that have had their connection status disabled, for reasons such as STP loopback detection or link down status. Clicking this link will display the following window:

Err-Disabled Ports			
Port	Port State	Connection Status	Reason
2	Disabled	--	STP LBD
5	Disabled	--	STP LBD
8	Disabled	--	STP LBD
11	Disabled	--	STP LBD
14	Disabled	--	STP LBD
17	Disabled	--	STP LBD
20	Disabled	--	STP LBD
23	Disabled	--	STP LBD
26	Disabled	--	STP LBD

[Return to Port Setting page](#)

Figure 6- 4. Err-Disabled Ports window

Port Description

The Switch supports a port description feature where the user may name various ports on the Switch. To assign names to various ports, click **Administration > Port Configuration > Port Description** to view the following window:

Port Description

From	To	Description	Apply
Port 1 ▾	Port 1 ▾	<input style="width: 90%;" type="text"/>	<input type="button" value="Apply"/>

Port Description Table

Port	Description
1	
2	
3	
4	
5	
6	
7	
8	
9	
10	
11	
12	
13	
14	
15	
16	
17	
18	
19	
20	
21	
22	
23	
24	
25	
26	
27	
28	

Figure 6- 5. Port Description Setting window

Use the **From** and **To** pull down menu to choose a port or range of ports to describe, and then enter a description of the port(s). Click **Apply** to set the descriptions in the Port Description Table.

PoE Configuration

DES-3828P supports Power over Ethernet (PoE) as defined by the IEEE 802.3af specification. Ports 1-24 can supply 48 VDC power to Power Devices (PDs) over Category 5 or Category 3 UTP Ethernet cables. DES-3828P follows the standard PSE (Power Source over Ethernet) pinout *Alternative A*, whereby power is sent out over pins 1, 2, 3 and 6. DES-3828P works with all D-Link 802.3af capable devices. The Switch also works in PoE mode with all non-802.3af capable D-Link AP, IP Cam and IP phone equipment via DWL-P50.

DES-3828P includes the following PoE features:

- Auto-discovery recognizes the connection of a PD (Power Device) and automatically sends power to it.
- The Auto-disable feature will occur under two conditions: first, if the total power consumption exceeds the system power limit; and second, if the per port power consumption exceeds the per port power limit.
- Active circuit protection automatically disables the port if there is a short. Other ports will remain active.

PDs receive power according to the following classification:

Class	Max power used by PD
0	0.44 to 12.95W
1	0.44 to 3.84W
2	3.84 to 6.49W
3	6.49 to 12.95W

PSE provides power according to the following classification:

Class	Max power used by PSE
0	15.4W
1	4.0W
2	7.0W
3	15.4W

To configure the PoE features on the DES-3828P, click **Administration > PoE Configuration**. The **PoE System** window is used to assign a power limit and power disconnect method for the whole PoE system. To configure the **Power Limit** for the PoE system, enter a value between 37W and 370W in the Power Limit field. The default setting is 370W. When the total consumed power exceeds the power limit, the PoE controller (located in the PSE) disconnects the power to prevent overloading the power supply.

To configure PoE for the Switch, click **Administration > PoE Configuration**, which will reveal the following window for the user to configure:

Figure 6- 6. PoE Configuration window

The previous window contains the following fields to configure for PoE:

Parameter	Description
PoE System	
Power Limit	Sets the limit of power to be used from the Switch's power source to PoE ports. The user may configure a Power Limit between 37 and 370w.
Power Disconnect Method	The PoE controller uses either Deny next port or Deny low priority port to offset the power limit being exceeded and keep the Switch's power at a usable level. Use the drop down menu to select a Power Disconnect Method method. The default for the Power Disconnect Method is Deny next port . Both Power Disconnection Methods are described below:

Power Disconnect Method	<p>The PoE controller uses either Deny next port or Deny low priority port to offset the power limit being exceeded and keep the Switch's power at a usable level. Use the drop down menu to select a Power Disconnect Method method. The default for the Power Disconnect Method is Deny next port. Both Power Disconnection Methods are described below:</p> <p>Deny next port - After the power limit has been exceeded, the next port attempting to power up is denied, regardless of its priority.</p> <p>Deny low priority port - After the power limit has been exceeded, the next port attempting to power up causes the port with the lowest priority to shut down to allow the high-priority and critical priority ports to power up.</p>
PoE Configuration	
From... To...	Select a range of ports from the pull-down menus to be enabled or disabled for PoE.
State	Use the pull-down menu to enable or disable ports for PoE.
Priority	Use the pull-down menu to select the priority of the PoE ports.
Power Limit	Sets the power limit per PoE port. Once this threshold has been reached on the port, the PoE will go into the Power Disconnect Method, as described above. The user may set a limit between 1000 and 16800mW

Click **Apply** to implement changes made to the PoE settings. The port status of all PoE configured ports is displayed in the table in the bottom half of the screen above.

User Accounts

Use the **User Account Management** window to control user privileges. To view existing User Accounts, open the **Administration** folder and click on the **User Accounts** link. This will open the **User Account Management** window, as shown below.

User Accounts		
User Name	Access Right	
Darren	Admin	<input type="button" value="Add"/> <input type="button" value="Modify"/>

Figure 6- 7. User Accounts window

To add a new user, click on the **Add** button. To modify or delete an existing user, click on the **Modify** button for that user.

User Account Add Table	
User Name	<input type="text"/>
New Password	<input type="password"/>
Confirm New Password	<input type="password"/>
Access Right	Admin <input type="button" value="v"/>
<input type="button" value="Apply"/>	
Show All User Account Entries	

Figure 6- 8. User Accounts Add Table

Add a new user by typing in a User Name, and New Password and retype the same password in the Confirm New Password. Choose the level of privilege (*Admin* or *User*) from the Access Right drop-down menu.

User Account Modify Table	
User Name	Darren
Old Password	<input type="text"/>
New Password	<input type="text"/>
Confirm New Password	<input type="text"/>
Access Right	Admin
<input type="button" value="Apply"/> <input type="button" value="Delete"/>	
Show All User Account Entries	

Figure 6- 9. User Accounts Modify Table

Modify or delete an existing user account in the **User Account Modify Table**. To delete the user account, click on the **Delete** button. To change the password, type in the *New Password* and retype it in the *Confirm New Password* entry field. The level of privilege (*Admin* or *User*) can be viewed in the **Access Right** field.

Port Mirroring

The Switch allows you to copy frames transmitted and received on a port and redirect the copies to another port. You can attach a monitoring device to the mirrored port, such as a sniffer or an RMON probe, to view details about the packets passing through the first port. This is useful for network monitoring and troubleshooting purposes. To view the **Port Mirroring** window, click **Port Mirroring** in the **Administration** folder.

Port Mirroring

Target	Port: Port 1 ▼													
Status	Disabled ▼													
Port	1	2	3	4	5	6	7	8	9	10	11	12	13	14
None	<input checked="" type="radio"/>	<input checked="" type="radio"/>	<input checked="" type="radio"/>	<input checked="" type="radio"/>	<input checked="" type="radio"/>	<input checked="" type="radio"/>	<input checked="" type="radio"/>	<input checked="" type="radio"/>	<input checked="" type="radio"/>	<input checked="" type="radio"/>	<input checked="" type="radio"/>	<input checked="" type="radio"/>	<input checked="" type="radio"/>	<input checked="" type="radio"/>
Ingress	<input type="radio"/>	<input type="radio"/>	<input type="radio"/>	<input type="radio"/>	<input type="radio"/>	<input type="radio"/>	<input type="radio"/>	<input type="radio"/>	<input type="radio"/>	<input type="radio"/>	<input type="radio"/>	<input type="radio"/>	<input type="radio"/>	<input type="radio"/>
Egress	<input type="radio"/>	<input type="radio"/>	<input type="radio"/>	<input type="radio"/>	<input type="radio"/>	<input type="radio"/>	<input type="radio"/>	<input type="radio"/>	<input type="radio"/>	<input type="radio"/>	<input type="radio"/>	<input type="radio"/>	<input type="radio"/>	<input type="radio"/>
Both	<input type="radio"/>	<input type="radio"/>	<input type="radio"/>	<input type="radio"/>	<input type="radio"/>	<input type="radio"/>	<input type="radio"/>	<input type="radio"/>	<input type="radio"/>	<input type="radio"/>	<input type="radio"/>	<input type="radio"/>	<input type="radio"/>	<input type="radio"/>
Port	15	16	17	18	19	20	21	22	23	24	25	26	27	28
None	<input checked="" type="radio"/>	<input checked="" type="radio"/>	<input checked="" type="radio"/>	<input checked="" type="radio"/>	<input checked="" type="radio"/>	<input checked="" type="radio"/>	<input checked="" type="radio"/>	<input checked="" type="radio"/>	<input checked="" type="radio"/>	<input checked="" type="radio"/>	<input checked="" type="radio"/>	<input checked="" type="radio"/>	<input checked="" type="radio"/>	<input checked="" type="radio"/>
Ingress	<input type="radio"/>	<input type="radio"/>	<input type="radio"/>	<input type="radio"/>	<input type="radio"/>	<input type="radio"/>	<input type="radio"/>	<input type="radio"/>	<input type="radio"/>	<input type="radio"/>	<input type="radio"/>	<input type="radio"/>	<input type="radio"/>	<input type="radio"/>
Egress	<input type="radio"/>	<input type="radio"/>	<input type="radio"/>	<input type="radio"/>	<input type="radio"/>	<input type="radio"/>	<input type="radio"/>	<input type="radio"/>	<input type="radio"/>	<input type="radio"/>	<input type="radio"/>	<input type="radio"/>	<input type="radio"/>	<input type="radio"/>
Both	<input type="radio"/>	<input type="radio"/>	<input type="radio"/>	<input type="radio"/>	<input type="radio"/>	<input type="radio"/>	<input type="radio"/>	<input type="radio"/>	<input type="radio"/>	<input type="radio"/>	<input type="radio"/>	<input type="radio"/>	<input type="radio"/>	<input type="radio"/>

Note(1): The "Source Port" and "Target Port" should be different, or the setup will be invalid.

Note(2): The target port should be a non-trunked port.

Figure 6- 10. Port Mirroring window

To configure a mirror port:

1. Select the Source Port from where you want to copy frames and the Target Port, which receives the copies from the source port.
2. Select the Source Direction, Ingress, Egress, or Both and change the Status drop-down menu to *Enabled*.
3. Click **Apply** to let the changes take effect.

System Log Settings

The Switch can send Syslog messages to up to four designated servers using the **System Log Server**. In the **Administration** folder, click **System Log Settings**, to view the window shown below.

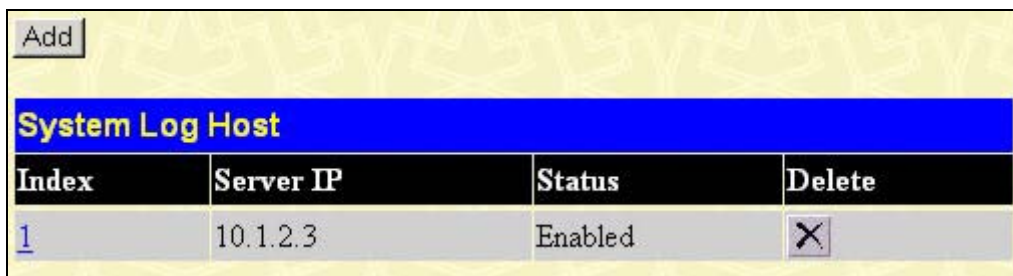

Figure 6- 11. System Log Host window

The parameters configured for adding and editing **System Log Server** settings are the same. See the table below for a description.

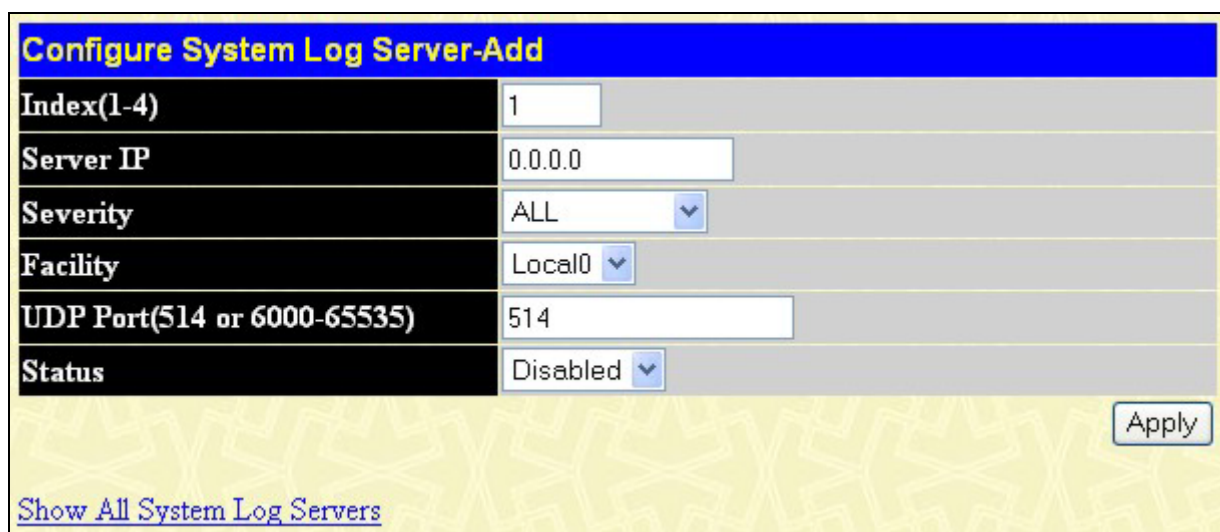

Figure 6- 12. Configure System Log Server – Add

The following parameters can be set:

Parameter	Description		
Index	Syslog server settings index (1-4).		
Server IP	The IP address of the Syslog server.		
Severity	This drop-down menu allows you to select the level of messages that will be sent. The options are <i>Warning</i> , <i>Informational</i> , and <i>All</i> .		
Facility	Some of the operating system daemons and processes have been assigned Facility values. Processes and daemons that have not been explicitly assigned a Facility may use any of the "local use" facilities or they may use the "user-level" Facility. Those Facilities that have been designated are shown in the following: Bold font indicates the facility values that the Switch is currently employing. <table border="0"> <tr> <td>Numerical Code</td> <td>Facility</td> </tr> </table>	Numerical Code	Facility
Numerical Code	Facility		

	0	kernel messages
	1	user-level messages
	2	mail system
	3	system daemons
	4	security/authorization messages
	5	messages generated internally by syslog line printer subsystem
	7	network news subsystem
	8	UUCP subsystem
	9	clock daemon
	10	security/authorization messages
	11	FTP daemon
	12	NTP subsystem
	13	log audit
	14	log alert
	15	clock daemon
	16	local use 0 (local0)
	17	local use 1 (local1)
	18	local use 2 (local2)
	19	local use 3 (local3)
	20	local use 4 (local4)
	21	local use 5 (local5)
	22	local use 6 (local6)
	23	local use 7 (local7)
UDP Port (514 or 6000-65535)	Type the UDP port number used for sending Syslog messages. The default is 514.	
Status	Choose <i>Enabled</i> or <i>Disabled</i> to activate or deactivate.	

Figure 6- 13. Configure System Log Server– Edit

To set the System Log Server configuration, click **Apply**. To delete an entry from the **System Log Host** window, click the corresponding **X** under the Delete heading of the entry to delete. To return to the **System Log Host** window, click the [Show All System Log Servers link](#).



NOTE: You cannot mirror a fast port onto a slower port. For example, if you try to mirror the traffic from a 100 Mbps port onto a 10 Mbps port, this can cause throughput problems. The port you are copying frames from should always support an equal or lower speed than the port to which you are sending the copies. Also, the target port for the mirroring cannot be a member of a trunk group. Please note a target port and a source port cannot be the same port.

System Severity Settings

The Switch can be configured to allow alerts be logged or sent as a trap to an SNMP agent or both. The level at which the alert triggers either a log entry or a trap message can be set as well. Use the System Severity Settings menu to set the criteria for alerts. The current settings are displayed below the Settings menu. In the **Administration** folder, click **System Severity Settings**, to view the window shown below.

System Severity Settings	
System Severity	trap
Severity Level	critical
Apply	
System Severity Table	
System Severity Log	information
System Severity Trap	critical

Figure 6- 14. System Severity Settings

Use the drop-down menus to configure the parameters described below.

Parameter	Description
System Severity	Choose how the alerts are used from the drop-down menu. Select <i>log</i> to send the alert of the Severity Type configured to the Switch's log for analysis. Choose <i>trap</i> to send it to an SNMP agent for analysis. Select <i>all</i> to send the chosen alert type to an SNMP agent and the Switch's log for analysis.
Severity Level	Choose what level of alert will trigger sending the log entry or trap message as defined by the Severity Name. Select <i>critical</i> to send only critical events to the Switch's log or SNMP agent. Choose <i>warning</i> to send critical and warning events to the Switch's log or SNMP agent. Select <i>information</i> to send informational, warning and critical events to the Switch's log or SNMP agent.

Click **Apply** to implement the new System Severity Settings.

SNTP Settings

Time Settings

To configure the time settings for the Switch, open the **Administration** folder. Then the **SNTP Settings** folder and click on the **Time Settings** link, revealing the following window for the user to configure.

The screenshot shows a web-based configuration window titled "Time Settings-Current Time". It contains three rows of information: "System Boot Time" (31 Dec 1999 18:56:41), "Current Time" (31 Dec 1999 19:26:12), and "Time Source" (System Clock). Below this is a section titled "SNTP Settings" with four rows: "SNTP State" (Disabled), "SNTP Primary Server" (0.0.0.0), "SNTP Secondary Server" (0.0.0.0), and "SNTP Poll Interval in Seconds(30-99999)" (720). An "Apply" button is located at the bottom right of this section. The bottom part of the window is titled "Time Settings - Set Current Time" and contains four rows: "Year" (2002), "Month" (January), "Day" (01), and "Time in HH MM SS" (00:00:00). An "Apply" button is also present at the bottom right of this section.

Figure 6- 15. Time Settings window

The following parameters can be set or are displayed:

Parameter	Description
Current Time	
System Boot Time	Displays the time when the Switch was initially started for this session.
Current Time	Displays the Current Time set on the Switch.
Time Source	Displays the time source for the system.
SNTP Settings	
SNTP State	Use this pull-down menu to <i>Enabled</i> or <i>Disabled</i> SNTP.
SNTP Primary Server	This is the IP address of the primary server the SNTP information will be taken from.
SNTP Secondary Server	This is the IP address of the secondary server the SNTP information will be taken from.
SNTP Poll Interval in Seconds (30-99999)	This is the interval, in seconds, between requests for updated SNTP information.
Set Current Time	
Year	Enter the current year, if you want to update the system clock.
Month	Enter the current month, if you would like to update the system clock.
Day	Enter the current day, if you would like to update the system clock.
Time in HH MM SS	Enter the current time in hours, minutes, and seconds.

Click **Apply** to implement your changes.

Time Zone and DST

The following are windows used to configure time zones and Daylight Savings time settings for SNTP. Open the **Administration** folder, then the **SNTP Settings** folder and click on the **Time Zone and DST** link, revealing the following window.

Time Zone and DST

Daylight Saving Time State: Disabled

Daylight Saving Time Offset in Minutes: 60

Time Zone Offset:from GMT in +/-HH:MM: - 06 00

DST Repeating Settings

From: Which Day: First

From: Day of Week: Sunday

From: Month: April

From: Time in HH MM: 00 00

To: Which Day: Last

To: Day of Week: Sunday

To: Month: October

To: Time in HH MM: 00 00

DST Annual Settings

From: Month: April

From: Day: 29

From: Time in HH MM: 00 00

To: Month: October

To: Day: 12

To: Time in HH MM: 00 00

Apply

Figure 6- 16. Time Zone and DST Settings window

The following parameters can be set:

Parameter	Description
Time Zone and DST	
Daylight Saving Time State	Use this pull-down menu to enable or disable the DST Settings.
Daylight Saving Time Offset in Minutes	Use this pull-down menu to specify the amount of time that will constitute your local DST offset - 30, 60, 90, or 120 minutes.
Time Zone Offset from GMT in +/- HH:MM	Use these pull-down menus to specify your local time zone's offset from Greenwich Mean Time (GMT.)

DST Repeating Settings

Using repeating mode will enable DST seasonal time adjustment. Repeating mode requires that the DST beginning and ending date be specified using a formula. For example, specify to begin DST on Saturday during the second week of April and end DST on Sunday during the last week of October.

From: Which Day	Enter the week of the month that DST will start.
From: Day of Week	Enter the day of the week that DST will start on.
From: Month	Enter the month DST will start on.
From: Time in HH:MM	Enter the time of day that DST will start on.
To: Which Day	Enter the week of the month the DST will end.
To: Day of Week	Enter the day of the week that DST will end.
To: Month	Enter the month that DST will end.
To: Time in HH:MM	Enter the time DST will end.

DST Annual Settings

Using annual mode will enable DST seasonal time adjustment. Annual mode requires that the DST beginning and ending date be specified concisely. For example, specify to begin DST on April 3 and end DST on October 14.

From: Month	Enter the month DST will start on, each year.
From: Day	Enter the day of the week DST will start on, each year.
From: Time in HH:MM	Enter the time of day DST will start on, each year.
To: Month	Enter the month DST will end on, each year.
To: Day	Enter the day of the week DST will end on, each year.
To: Time in HH:MM	Enter the time of day that DST will end on, each year.

Click **Apply** to implement changes made to the **Time Zone and DST** window.

MAC Notification Settings

MAC Notification is used to monitor MAC addresses learned and entered into the forwarding database. To globally set MAC notification on the Switch, open the following window by opening the **MAC Notification Settings** in the Administration folder.

Global Settings

The following parameters may be viewed and modified:

Parameter	Description
State	Enable or disable MAC notification globally on the Switch
Interval (sec)	The time in seconds between notifications.
History Size	The maximum number of entries listed in the history log used for notification. Up to 500 entries can be specified.

Port Settings

To change MAC notification settings for a port or group of ports on the Switch, configure the following parameters.

Parameter	Description
From...To	Select a port or group of ports to enable for MAC notification using the pull-down menus.
State	Enable MAC Notification for the ports selected using the pull-down menu.

Click **Apply** to implement changes made.

MAC Notification Global Settings

State: Disabled
 Interval (1-2147483647 sec): 1
 History Size (1-500): 1

New MAC Notification Global Settings

State: Disabled
 Interval (1-2147483647 sec): 1
 History Size (1-500): 1
 Apply

MAC Notification Port Settings

From: Port 1 | To: Port 1 | State: Disabled | Apply

MAC Notification Port State Table

Port	State
1	Disabled
2	Disabled
3	Disabled
4	Disabled
5	Disabled
6	Disabled
7	Disabled
8	Disabled
9	Disabled
10	Disabled
11	Disabled
12	Disabled
13	Disabled
14	Disabled
15	Disabled
16	Disabled
17	Disabled
18	Disabled
19	Disabled
20	Disabled
21	Disabled
22	Disabled
23	Disabled
24	Disabled
25	Disabled
26	Disabled
27	Disabled
28	Disabled

Figure 6- 17. MAC Notification Settings

TFTP Services

Trivial File Transfer Protocol (TFTP) services allow the Switch's firmware to be upgraded by transferring a new firmware file from a TFTP server to the Switch. A configuration file can also be loaded into the Switch from a TFTP server. Switch settings can be saved to the TFTP server, and a history log can be uploaded from the Switch to the TFTP server. The TFTP server must be running TFTP server software to perform the file transfer.

Figure 6- 18. TFTP Services window

TFTP server software is a part of many network management software packages – such as NetSight, or can be obtained as a separate program. To update the Switch's firmware or configuration file, open the **TFTP Services** hyperlink, located in the **Administration** folder.

The following parameters can be configured:

Parameter	Description
Active	<p>Select a service for the TFTP server to perform from the drop down window:</p> <ul style="list-style-type: none"> • Download Firmware - Enter the IP address of the TFTP server and specify the location of the new firmware on the TFTP server. Click Start to record the IP address of the TFTP server and to initiate the file transfer. • Download Configuration - Enter the IP address of the TFTP server, and the path and filename for the Configuration file on the TFTP server. Click Start to record the IP address of the TFTP server and to initiate the file transfer. • Upload Configuration - Enter the IP address of the TFTP server and the path and filename for the switch settings on the TFTP server. Click Start to record the IP address of the TFTP server and to initiate the file transfer. • Upload Log - Enter the IP address of the TFTP server and the path and filename for the history log on the TFTP server. Click Start to record the IP address of the TFTP server and to initiate the file transfer.
Image ID	<p>Select the Image ID of the firmware. The Switch can hold two firmware images in its memory. Image ID 1 will always be the boot up firmware for the Switch unless specified by the user. Choosing Active will download the firmware to the Boot Up Image ID, depending on the user's configuration. Information on configuring Image IDs can be found in this section, under the heading Multiple Image Services.</p>
Configuration ID	<p>Select the Configuration ID for uploading or downloading configuration files from or to the Switch. Like the Image ID, the Switch can hold two configuration files in its memory. Choosing Active will download the configuration to the Boot Up Configuration ID, depending on the user's configuration.</p>
Server IP Address	<p>Enter the IP address of the server from which to download firmware or configuration files.</p>
File Name	<p>Enter the path and filename of the firmware or configuration file that you wish to upload or download.</p>

Multiple Image Services

The **Multiple Image Services** folder allows switch administrators of the Switch to configure and view information regarding firmware located on the Switch. The Switch allows two firmware images to be stored in its memory and either may be configured to be the boot up firmware for the Switch. For information regarding firmware images located on the Switch, open the **Firmware Information** link. The default setting for the Switch’s firmware will have the boot up firmware stored in Image 1, but the user may set either firmware stored to be the boot up firmware by using configuration screens located in the **Dual Configurations Services** folder.

Firmware Information

The following screen allows the user to view information about current firmware images stored on the Switch. To access the following screen, click **Administration > Multiple Image Services**.

Firmware Information							
ID	Version	Size	Update Time	From	User	Boot	Delete
1	2.00.B20	4494711	1999/12/31 18:10:53	10.53.13.95	Anonymous	<input checked="" type="radio"/>	<input type="button" value="X"/>
2	1.00.B31	4348239	1999/12/31 18:07:52	10.38.45.11	Anonymous	<input type="radio"/>	<input type="button" value="X"/>

(T) means firmware update through TELNET
 (S) means firmware update through SNMP
 (W) means firmware update through WEB
 (SIM) means firmware update through Single IP Management

Figure 6- 19. Firmware Information window

This window holds the following information:

Parameter	Description
ID	States the image ID number of the firmware in the Switch’s memory. The Switch can store two firmware images for use. Image ID 1 will be the default boot up firmware for the Switch unless otherwise configured by the user.
Version	States the firmware version.
Size	States the size of the corresponding firmware, in bytes.
Update Time	States the specific time the firmware version was downloaded to the Switch.
From	States the IP address of the origin of the firmware. There are five ways firmware may be downloaded to the Switch. <ul style="list-style-type: none"> • T - If the IP address has this letter attached to it, it denotes a firmware upgrade through Telnet. • S - If the IP address has this letter attached to it, it denotes a firmware upgrade through the Simple Network Management Protocol (SNMP). • W - If the IP address has this letter attached to it, it denotes a firmware upgrade through the web-based management interface. • SIM – If the IP address has these letters attached, it denotes a firmware upgrade through the Single IP Management feature.
User	States the user who downloaded the firmware. This field may read “Anonymous” or “Unknown” for users that are unidentified.

Dual Configuration Services

The following window is used to configure firmware information set in the Switch. The xStack DES-3800 series has the capability to store two firmware images in its memory. To view this window, open the **Administration** folder and click **Dual Configuration Services**, which will in turn display the following window.

Config Information								
ID	Version	Size	Update Time	From	User	boot_up	Delete	Apply
1	2.00.B18	9282	1999/12/31 18:59:10	Local Saved	Anonymous	<input checked="" type="radio"/>	<input type="checkbox"/>	Apply
2	(empty)							

Figure 6- 20. Config Information window

This window holds the following information:

Parameter	Description
ID	States the ID number of the configuration file located in the Switch's memory. The Switch can store two configuration files for use. ID 1 will be the default boot up configuration file for the Switch unless otherwise configured by the user.
Version	Displays the firmware version set in the Switch.
Size	Displays the size of the configuration file, in bytes.
Update time	Displays the time that the configuration file was updated to the Switch.
From	Displays the location from which the configuration file was uploaded.
User	Displays the name of the user (device) that updated this configuration file. Unknown users will be displayed as Anonymous.
Boot Up	Click the radio button under this heading to use this configuration file as the boot up firmware for the Switch. This will apply upon the next reboot of the Switch.
Delete	Click the corresponding <input type="checkbox"/> under this heading to delete this configuration file from the Switch's memory.
Apply	Click Apply to implement any changes made to the configuration file settings.

Ping Test

Ping is a small program that sends ICMP Echo packets to the IP address you specify. The destination node then responds to or "echoes" the packets sent from the Switch. This is very useful to verify connectivity between the Switch and other nodes on the network.

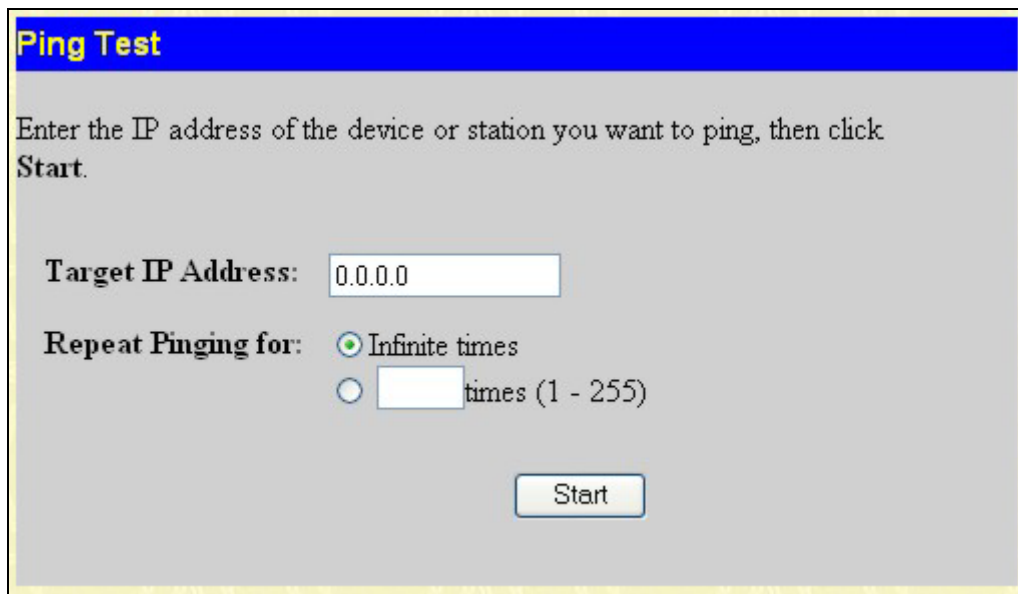

Ping Test

Enter the IP address of the device or station you want to ping, then click **Start**.

Target IP Address:

Repeat Pinging for: Infinite times
 times (1 - 255)

Figure 6- 21. Ping Test window

The user may use Infinite times radio button, in the **Repeat Pinging for** field, which will tell the ping program to keep sending ICMP Echo packets to the specified IP address until the program is stopped. The user may opt to choose a specific number of times to ping the **Target IP Address** by clicking its radio button and entering a number between 1 and 255. Click **Start** to initiate the Ping program.

SNMP Manager

SNMP Settings

Simple Network Management Protocol (SNMP) is an OSI Layer 7 (Application Layer) designed specifically for managing and monitoring network devices. SNMP enables network management stations to read and modify the settings of gateways, routers, switches, and other network devices. Use SNMP to configure system features for proper operation, monitor performance and detect potential problems in the Switch, switch group or network.

Managed devices that support SNMP include software (referred to as an agent), which runs locally on the device. A defined set of variables (managed objects) is maintained by the SNMP agent and used to manage the device. These objects are defined in a Management Information Base (MIB), which provides a standard presentation of the information controlled by the on-board SNMP agent. SNMP defines both the format of the MIB specifications and the protocol used to access this information over the network.

The DES-3800 Series supports the SNMP versions 1, 2c, and 3. The default SNMP setting is disabled. You must enable SNMP. Once SNMP is enabled you can choose which version you want to use to monitor and control the Switch. The three versions of SNMP vary in the level of security provided between the management station and the network device.

In SNMP v.1 and v.2, user authentication is accomplished using 'community strings', which function like passwords. The remote user SNMP application and the Switch SNMP must use the same community string. SNMP packets from any station that has not been authenticated are ignored (dropped).

The default community strings for the Switch used for SNMP v.1 and v.2 management access are:

- **public** - Allows authorized management stations to retrieve MIB objects.
- **private** - Allows authorized management stations to retrieve and modify MIB objects.

SNMPv3 uses a more sophisticated authentication process that is separated into two parts. The first part is to maintain a list of users and their attributes that are allowed to act as SNMP managers. The second part describes what each user on that list can do as an SNMP manager.

The Switch allows groups of users to be listed and configured with a shared set of privileges. The SNMP version may also be set for a listed group of SNMP managers. Thus, you may create a group of SNMP managers that are allowed to view read-only information or receive traps using SNMPv1 while assigning a higher level of security to another group, granting read/write privileges using SNMPv3.

Using SNMPv3 individual users or groups of SNMP managers can be allowed to perform or be restricted from performing specific SNMP management functions. The functions allowed or restricted are defined using the Object Identifier (OID) associated with a specific MIB. An additional layer of security is available for SNMPv3 in that SNMP messages may be encrypted. To read more about how to configure SNMPv3 settings for the Switch read the next section.

Traps

Traps are messages that alert network personnel of events that occur on the Switch. The events can be as serious as a reboot (someone accidentally turned OFF the Switch), or less serious like a port status change. The Switch generates traps and sends them to the trap recipient (or network manager). Typical traps include trap messages for Authentication Failure, Topology Change and Broadcast/Multicast Storm.

MIBs

The Switch in the Management Information Base (MIB) stores management and counter information. The Switch uses the standard MIB-II Management Information Base module. Consequently, values for MIB objects can be retrieved from any SNMP-based network management software. In addition to the standard MIB-II, the Switch also supports its own proprietary enterprise MIB as an extended Management Information Base. Specifying the MIB Object Identifier may also retrieve the proprietary MIB. MIB values can be either read-only or read-write.

The xStack DES-3800 Series incorporates a flexible SNMP management for the switching environment. SNMP management can be customized to suit the needs of the networks and the preferences of the network administrator. Use the SNMP V3 menus to select the SNMP version used for specific tasks.

The xStack DES-3800 Series supports the Simple Network Management Protocol (SNMP) versions 1, 2c, and 3. The administrator can specify the SNMP version used to monitor and control the Switch. The three versions of SNMP vary in the level of security provided between the management station and the network device.

SNMP settings are configured using the menus located on the SNMP V3 folder of the web manager. Workstations on the network that are allowed SNMP privileged access to the Switch can be restricted with the Management Station IP Address menu.

SNMP User Table

The **SNMP User Table** displays all of the SNMP User's currently configured on the Switch.

In the **SNMP Manager** folder, located in the **Administration** folder, click on the **SNMP User Table** link. This will open the **SNMP User Table** window, as shown below.



Figure 6- 22. SNMP User Table window

To delete an existing **SNMP User Table** entry, click the  below the Delete heading corresponding to the entry you wish to delete.

To display the detailed entry for a given user, click on the hyperlinked User Name. This will open the **SNMP User Table Display** window, as shown below.

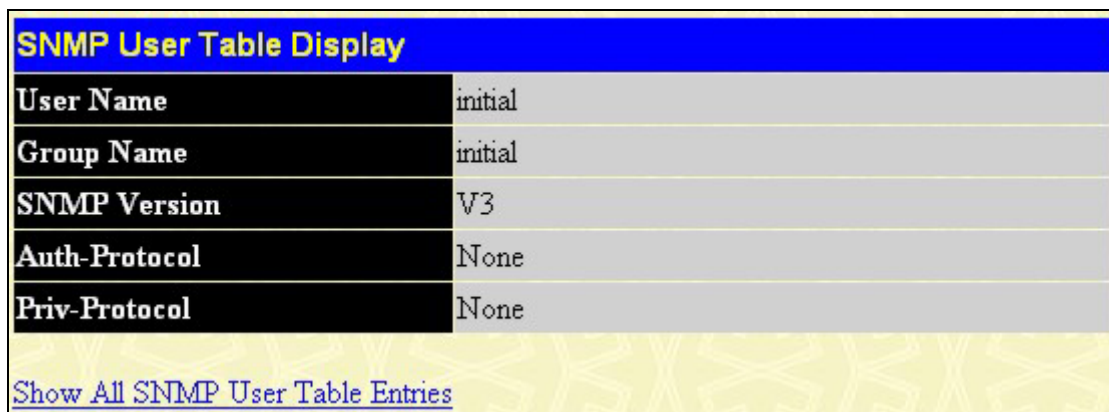

Figure 6- 23. SNMP User Table Display window

The following parameters are displayed:

Parameter	Description
User Name	An alphanumeric string of up to 32 characters. This is used to identify the SNMP users.
Group Name	This name is used to specify the SNMP group created can request SNMP messages.
SNMP Version	V1 - Indicates that SNMP version 1 is in use. V2 - Indicates that SNMP version 2 is in use. V3 - Indicates that SNMP version 3 is in use.
Auth-Protocol	<i>None</i> - Indicates that no authorization protocol is in use. <i>MD5</i> - Indicates that the HMAC-MD5-96 authentication level will be used. <i>SHA</i> - Indicates that the HMAC-SHA authentication protocol will be used.
Priv-Protocol	<i>None</i> - Indicates that no authorization protocol is in use. <i>DES</i> - Indicates that DES 56-bit encryption is in use based on the CBC-DES (DES-56) standard.

To return to the SNMP User Table, click the [Show All SNMP User Table Entries](#) link. To add a new entry to the **SNMP User Table Configuration** window, click on the **Add** button on the **SNMP User Table** window. This will open the **SNMP User Table Configuration** window, as shown below.

Figure 6- 24. SNMP User Table Configuration window

The following parameters can set:

Parameter	Description
User Name	Enter an alphanumeric string of up to 32 characters. This is used to identify the SNMP user.
Group Name	This name is used to specify the SNMP group created can request SNMP messages.
SNMP Version	V1 - Specifies that SNMP version 1 will be used. V2 - Specifies that SNMP version 2 will be used. V3 - Specifies that SNMP version 3 will be used.
Auth-Protocol	MD5 - Specifies that the HMAC-MD5-96 authentication level will be used. This field is only operable when V3 is selected in the SNMP Version field and the Encryption field has been checked. This field will require the user to enter a password. SHA - Specifies that the HMAC-SHA authentication protocol will be used. This field is only operable when V3 is selected in the SNMP Version field and the Encryption field has been checked. This field will require the user to enter a password.
Priv-Protocol	None - Specifies that no authorization protocol is in use. DES - Specifies that DES 56-bit encryption is in use, based on the CBC-DES (DES-56) standard. This field is only operable when V3 is selected in the SNMP Version field and the Encryption field has been checked. This field will require the user to enter a password between 8 and 16 alphanumeric characters.
Encrypted	Checking the corresponding box will enable encryption for SNMP V3 and is only operable in SNMP V3 mode.

To implement changes made, click **Apply**. To return to the SNMP User Table, click the [Show All SNMP User Table Entries](#) link.

SNMP View Table

The SNMP View Table is used to assign views to community strings that define which MIB objects can be accessed by a remote SNMP manager. To view the **SNMP View Table** window, open the **SNMP Manager** folder under **Administration** and click the **SNMP View Table** entry. The following window should appear:

Add

Total Entries:8 (Note:Maximum of 30 entries.)

SNMP View Table			
View Name	Subtree	View Type	Delete
restricted	1.3.6.1.2.1.1	Included	X
restricted	1.3.6.1.2.1.11	Included	X
restricted	1.3.6.1.6.3.10.2.1	Included	X
restricted	1.3.6.1.6.3.11.2.1	Included	X
restricted	1.3.6.1.6.3.15.1.1	Included	X
CommunityView	1	Included	X
CommunityView	1.3.6.1.6.3	Excluded	X
CommunityView	1.3.6.1.6.3.1	Included	X

Figure 6- 25. SNMP View Table window

To delete an existing SNMP View Table entry, click the **X** in the Delete column corresponding to the entry to delete. To create a new entry, click the **Add** button and a separate window will appear.

SNMP View Table Configuration

View Name

Subtree OID

View Type

Apply

[Show All SNMP View Table Entries](#)

Figure 6- 26. SNMP View Table Configuration window

The SNMP Group created with this table maps SNMP users (identified in the SNMP User Table) to the views created in the previous window.

The following parameters can set:

Parameter	Description
View Name	Type an alphanumeric string of up to 32 characters. This is used to identify the new SNMP view being created.
Subtree OID	Type the Object Identifier (OID) Subtree for the view. The OID identifies an object tree (MIB tree) that will be included or excluded from access by an SNMP manager.
View Type	Select Included to include this object in the list of objects that an SNMP manager can access. Select Excluded to exclude this object from the list of objects that an SNMP manager can access.

To implement your new settings, click **Apply**. To return to the **SNMP View Table**, click the [Show All SNMP View Table Entries](#) link.

SNMP Group Table

An SNMP Group created with this table maps SNMP users (identified in the SNMP User Table) to the views created in the previous menu. To view the **SNMP Group Table** window, open the **SNMP Manager** folder in the **Administration** folder and click the **SNMP Group Table** entry. The following window should appear:

SNMP Group Table			
Group Name	Security Model	Security Level	Delete
public	SNMPv1	NoAuthNoPriv	<input type="checkbox"/>
public	SNMPv2	NoAuthNoPriv	<input type="checkbox"/>
initial	SNMPv3	NoAuthNoPriv	<input type="checkbox"/>
private	SNMPv1	NoAuthNoPriv	<input type="checkbox"/>
private	SNMPv2	NoAuthNoPriv	<input type="checkbox"/>
ReadGroup	SNMPv1	NoAuthNoPriv	<input type="checkbox"/>
ReadGroup	SNMPv2	NoAuthNoPriv	<input type="checkbox"/>
WriteGroup	SNMPv1	NoAuthNoPriv	<input type="checkbox"/>
WriteGroup	SNMPv2	NoAuthNoPriv	<input type="checkbox"/>

Figure 6- 27. SNMP Group Table window

To delete an existing SNMP Group Table entry, click the corresponding under the Delete heading.

To display the current settings for an existing **SNMP Group Table** entry, click the hyperlink for the entry under the **Group Name**.

SNMP Group Table Display	
Group Name	public
Read View Name	CommunityView
Write View Name	
Notify View Name	CommunityView
Security Model	SNMPv1
Security Level	NoAuthNoPriv
Show All SNMP Group Table Entries	

Figure 6- 28. SNMP Group Table Display window

To add a new entry to the Switch's SNMP Group Table, click the **Add** button in the upper left-hand corner of the **SNMP Group Table** window. This will open the **SNMP Group Table Configuration** window, as shown below.

SNMP Group Table Configuration	
Group Name	<input type="text"/>
Read View Name	<input type="text"/>
Write View Name	<input type="text"/>
Notify View Name	<input type="text"/>
Security Model	SNMPv1 <input type="button" value="v"/>
Security Level	NoAuthNoPriv <input type="button" value="v"/>
<input type="button" value="Apply"/>	
Show All SNMP Group Table Entries	

Figure 6- 29. SNMP Group Table Configuration window

The following parameters can set:

Parameter	Description
Group Name	Type an alphanumeric string of up to 32 characters. This is used to identify the new SNMP group of SNMP users.
Read View Name	This name is used to specify the SNMP group created can request SNMP messages.
Write View Name	Specify a SNMP group name for users that are allowed SNMP write privileges to the Switch's SNMP agent.
Notify View Name	Specify a SNMP group name for users that can receive SNMP trap messages generated by the Switch's SNMP agent.
Security Model	<p><i>SNMPv1</i> - Specifies that SNMP version 1 will be used.</p> <p><i>SNMPv2</i> - Specifies that SNMP version 2c will be used. The SNMPv2 supports both centralized and distributed network management strategies. It includes improvements in the Structure of Management Information (SMI) and adds some security features.</p> <p><i>SNMPv3</i> - Specifies that the SNMP version 3 will be used. SNMPv3 provides secure access to devices through a combination of authentication and encrypting packets over the network.</p>
Security Level	<p>The Security Level settings only apply to SNMPv3.</p> <p><i>NoAuthNoPriv</i> - Specifies that there will be no authorization and no encryption of packets sent between the Switch and a remote SNMP manager.</p> <p><i>AuthNoPriv</i> - Specifies that authorization will be required, but there will be no encryption of packets sent between the Switch and a remote SNMP manager.</p> <p><i>AuthPriv</i> - Specifies that authorization will be required, and that packets sent between the Switch and a remote SNMP manger will be encrypted.</p>

To implement your new settings, click **Apply**. To return to the SNMP Group Table, click the [Show All SNMP Group Table Entries](#) link.

SNMP Community Table Configuration

Use this table to create an SNMP community string to define the relationship between the SNMP manager and an agent. The community string acts like a password to permit access to the agent on the Switch. One or more of the following characteristics can be associated with the community string:

- An Access List of IP addresses of SNMP managers that are permitted to use the community string to gain access to the Switch's SNMP agent.
- Any MIB view that defines the subset of all MIB objects will be accessible to the SNMP community.
- Read/write or read-only level permission for the MIB objects accessible to the SNMP community.

To configure SNMP Community entries, open the **SNMP Manager** folder, (located in the **Administration** folder) and click the **SNMP Community Table** link, which will open the following window:

SNMP Community Table		
Community Name	View Name	Access Right
<input type="text"/>	<input type="text"/>	Read_Only

Apply

Total Entries: 2 (Note: Maximum of 10 entries.)

SNMP Community Table			
Community Name	View Name	Access Right	Delete
private	CommunityView	Read_Write	X
public	CommunityView	Read_Only	X

Figure 6- 30. SNMP Community Table Configuration window

The following parameters can set:

Parameter	Description
Community Name	Type an alphanumeric string of up to 33 characters that is used to identify members of an SNMP community. This string is used like a password to give remote SNMP managers access to MIB objects in the Switch's SNMP agent.
View Name	Type an alphanumeric string of up to 32 characters that is used to identify the group of MIB objects that a remote SNMP manager is allowed to access on the Switch. The view name must exist in the SNMP View Table.
Access Right	<i>Read Only</i> - Specifies that SNMP community members using the community string created can only read the contents of the MIBs on the Switch. <i>Read Write</i> - Specifies that SNMP community members using the community string created can read from, and write to the contents of the MIBs on the Switch.

To implement the new settings, click **Apply**. To delete an entry from the **SNMP Community Table**, click the **X** under the Delete heading, corresponding to the entry to delete.

SNMP Host Table

Use the **SNMP Host Table** window to set up SNMP trap recipients. Open the **SNMP Manager** folder, (located in the **Administration** folder) and click on the **SNMP Host Table Configuration** link. This will open the **SNMP Host Table** window, as shown to the right. To delete an existing SNMP Host Table entry, click the corresponding **X** under the Delete heading. To display the current settings for an existing **SNMP Host Table** entry, click the blue link for the entry under the Host IP Address heading.

To add a new entry to the Switch's SNMP Host Table, click the **Add** button in the upper left-hand corner of the window. This will open the **SNMP Host Table Configuration** window, as shown to the right.

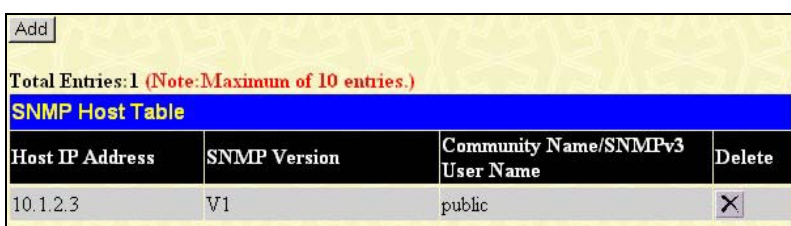

Figure 6- 31. SNMP Host Table window

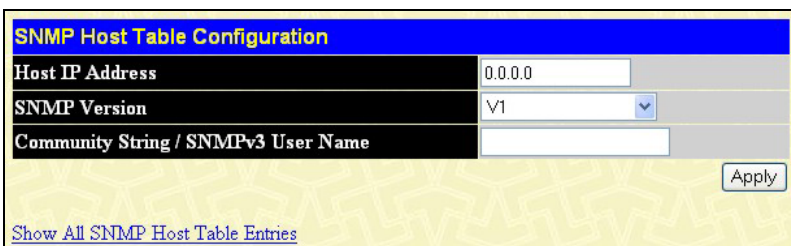

Figure 6- 32. SNMP Host Table Configuration window

The following parameters can set:

Parameter	Description
Host IP Address	Type the IP address of the remote management station that will serve as the SNMP host for the Switch.
SNMP Version	V1 - To specifies that SNMP version 1 will be used. V2 - To specify that SNMP version 2 will be used. V3-NoAuth-NoPriv - To specify that the SNMP version 3 will be used, with a NoAuth-NoPriv security level. V3-Auth-NoPriv - To specify that the SNMP version 3 will be used, with an Auth-NoPriv security level. V3-Auth-Priv - To specify that the SNMP version 3 will be used, with an Auth-Priv security level.
Community String/ SNMP V3 User Name	Type in the community string or SNMP V3 user name as appropriate.

To implement your new settings, click **Apply**. To return to the **SNMP Host Table**, click the [Show All SNMP Host Table Entries](#) link.

SNMP Engine ID

The Engine ID is a unique identifier used for SNMP V3 implementations. This is an alphanumeric string used to identify the SNMP engine on the Switch. To display the Switch's SNMP Engine ID, open the **SNMP Manger** folder, (located in the **Administration**) folder and click on the **SNMP Engine ID** link. This will open the **SNMP Engine ID Configuration** window, as shown below.

The image shows a web-based configuration window titled "SNMP Engine ID". The window has a blue header bar with the title in yellow. Below the header, there is a label "Engine ID" in a black box, followed by a text input field containing the alphanumeric string "800000ab03000102030400". To the right of the input field is a button labeled "Apply". The background of the window is light yellow with a faint pattern of network-related icons.

Figure 6- 33. SNMP Engine ID Configuration window

To change the Engine ID, type the new Engine ID in the space provided and click the **Apply** button.

D-Link Single IP Management

Single IP Management (SIM) Overview

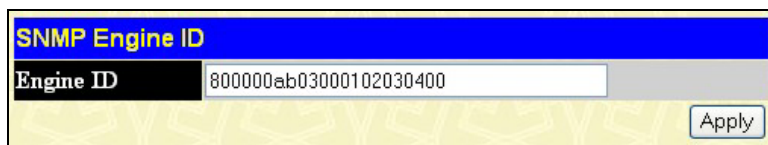
Simply put, D-Link Single IP Management is a concept that will stack switches together over Ethernet instead of using stacking ports or modules. There are some advantages in implementing the "Single IP Management" feature:

1. SIM can simplify management of small workgroups or wiring closets while scaling the network to handle increased bandwidth demand.
2. SIM can reduce the number of IP address needed in your network.
3. SIM can eliminate any specialized cables for stacking connectivity and remove the distance barriers that typically limit your topology options when using other stacking technology.

Switches using D-Link Single IP Management (labeled here as SIM) must conform to the following rules:

- SIM is an optional feature on the Switch and can easily be enabled or disabled through the Command Line Interface or Web Interface. SIM grouping has no effect on the normal operation of the Switch in the user's network.
- There are three classifications for SIM. The **Commander Switch (CS)**, which is the master switch of the group, **Member Switch (MS)**, which is a switch that is recognized by the CS as a member of a SIM group, and a **Candidate Switch (CaS)**, which is a Switch that has a physical link to the SIM group but has not been recognized by the CS as a member of the SIM group.
- A SIM group can only have one Commander Switch (CS).
- All switches in a particular SIM group must be in the same IP subnet (broadcast domain). Members of a SIM group cannot cross a router.
- A SIM group accepts up to 33 switches (numbered 0-32), including the Commander Switch (numbered 0).

There is no limit to the number of SIM groups in the same IP subnet (broadcast domain), however a single switch can only belong to one group.

If multiple VLANs are configured, the SIM group will only utilize the default VLAN on any switch.

SIM allows intermediate devices that do not support SIM. This enables the user to manage switches that are more than one hop away from the CS.

The SIM group is a group of switches that are managed as a single entity. SIM switches may take on three different roles:

1. **Commander Switch (CS)** - This is a switch that has been manually configured as the controlling device for a group, and takes on the following characteristics:
 - It has an IP Address.
 - It is not a commander switch or member switch of another Single IP group.
 - It is connected to the member switches through its management VLAN.
2. **Member Switch (MS)** - This is a switch that has joined a single IP group and is accessible from the CS, and it takes on the following characteristics:
 - It is not a CS or MS of another Single IP group.
 - It is connected to the CS through the CS management VLAN.
3. **Candidate Switch (CaS)** - This is a switch that is ready to join a SIM group but is not yet a member of the SIM group. The Candidate Switch may join the SIM group of a switch by manually configuring it to be a MS of a SIM group. A switch configured as a CaS is not a member of a SIM group and will take on the following characteristics:
 - It is not a CS or MS of another Single IP group.
 - It is connected to the CS through the CS management VLAN.

After configuring one switch to operate as the CS of a SIM group, additional switches may join the group through a direct connection to the Commander switch. Only the Commander switch will allow entry to the candidate switch enabled for SIM. The CS will then serve as the in band entry point for access to the MS. The CS's IP address will become the path to all MS's of the group and the CS's Administrator's password, and/or authentication will control access to all MS's of the SIM group.

With SIM enabled, the applications in the CS will redirect the packet instead of executing the packets. The applications will decode the packet from the administrator, modify some data, then send it to the MS. After execution, the CS may receive a response packet from the MS, which it will encode and send it back to the administrator.

When a CS becomes a MS, it automatically becomes a member of the first SNMP community (include read/write and read only) to which the CS belongs. However, if a MS has its own IP address, it can belong to SNMP communities to which other switches in the group, including the CS, do not belong.

The Upgrade to v1.50

To better improve SIM management, the xStack DES-3800 series switches have been upgraded to version 1.50 in this release. Many improvements have been made, including:

1. The Commander Switch (CS) now has the capability to automatically rediscover member switches that have left the SIM group, either through a reboot or web malfunction. This feature is accomplished through the use of Discover packets and Maintain packets that previously set SIM members will emit after a reboot. Once a MS has had its MAC address and password saved to the CS's database, if a reboot occurs in the MS, the CS will keep this MS information in its database and when a MS has been rediscovered, it will add the MS back into the SIM tree automatically. No configuration will be necessary to rediscover these switches.

There are some instances where pre-saved MS switches cannot be rediscovered. For example, if the Switch is still powered down, if it has become the member of another group, or if it has been configured to be a Commander Switch, the rediscovery process cannot occur.

2. The topology map now includes new features for connections that are a member of a port trunking group. It will display the speed and number of Ethernet connections creating this port trunk group, as shown in the adjacent picture.

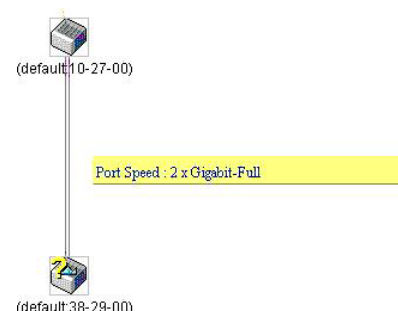

3. This version will support multiple switch upload and downloads for firmware, configuration files and log files, as follows:

Firmware – The switch now supports multiple MS firmware downloads from a TFTP server.

Configuration Files – This switch now supports multiple downloading and uploading of configuration files both to (for configuration restoration) and from (for configuration backup) MS's, using a TFTP server..

Log – The switch now supports uploading multiple MS log files to a TFTP server.

4. The user may zoom in and zoom out when utilizing the topology window to get a better, more defined view of the configurations.

SIM Using the Web Interface

All switches are set as Candidate (CaS) switches as their factory default configuration and Single IP Management will be disabled. To enable SIM for the Switch using the Web interface, go to the **Single IP Management Settings** folder, located in the **Administration** folder, and click the **SIM Settings** link, revealing the following window.



Figure 6- 34. SIM Settings window (disabled)

Change the **SIM State** to *Enabled* using the pull down menu and click **Apply**. The screen will then refresh and the **SIM Settings** window will look like this:

The screenshot shows the 'SIM Settings' window. The 'SIM State' is set to 'Enabled'. The 'Role State' is set to 'Candidate'. The 'Discovery Interval' is set to 30 seconds (range 30..90 sec). The 'Holdtime' is set to 100 seconds (range 100..255 sec). There is an 'Apply' button at the bottom right.

Figure 6- 35. SIM Settings window (enabled)

If the Switch Administrator wishes to configure the Switch as a Commander Switch (CS), select commander from the **Role State** field and click **Apply**. The window will change once again to look like this:

The screenshot shows the 'SIM Settings' window. The 'SIM State' is set to 'Enabled'. The 'Role State' is set to 'Commander'. The 'Discovery Interval' is set to 30 seconds (range 30..90 sec). The 'Holdtime' is set to 100 seconds (range 100..255 sec). The 'Group Name' is set to 'default'. There is an 'Apply' button at the bottom right.

Figure 6- 36. SIM Settings window (Commander enabled)

The following parameters can be set:

Parameters	Description
SIM State	Use the pull down menu to either enable or disable the SIM state on the Switch. <i>Disabled</i> will render all SIM functions on the Switch inoperable.
Role State	Use the pull down menu to change the SIM role of the Switch. The two choices are: <ul style="list-style-type: none"> <i>Candidate</i> - A Candidate Switch (CaS) is not the member of a SIM group but is connected to a Commander Switch. This is the default setting for the SIM role. <i>Commander</i> - Choosing this parameter will make the Switch a Commander Switch (CS). The user may join other switches to this Switch, over Ethernet, to be part of its SIM group. Choosing this option will also enable the Switch to be configured for SIM.
Discovery Interval	The user may set the discovery protocol interval, in seconds that the Switch will send out discovery packets. Returning information to a Commander Switch will include information about other switches connected to it. (Ex. MS, CaS). The user may set the Discovery Interval from 30 to 90 seconds.
Holdtime	This parameter may be set for the time, in seconds the Switch will hold information sent to it from other switches, utilizing the Discovery Interval . The user may set the hold time from 100 to 255 seconds.
Group	The administrator may set the name of the SIM group here, of which this Switch has been nominated Commander. The default name for the Group is <i>default</i> .

Click **Apply** to implement the settings changed.

After enabling the Switch to be a Commander Switch (CS), the **Single IP Management** folder will then contain four added links to aid the user in configuring SIM through the web, including **Topology**, **Firmware Upgrade** and **Configuration Backup/Restore** and **Upload Log File**.

Topology

The **Topology** window will be used to configure and manage the Switch within the SIM group and requires Java script to function properly on your computer.

The Java Runtime Environment on your server should initiate and lead you to the topology window, as seen below.

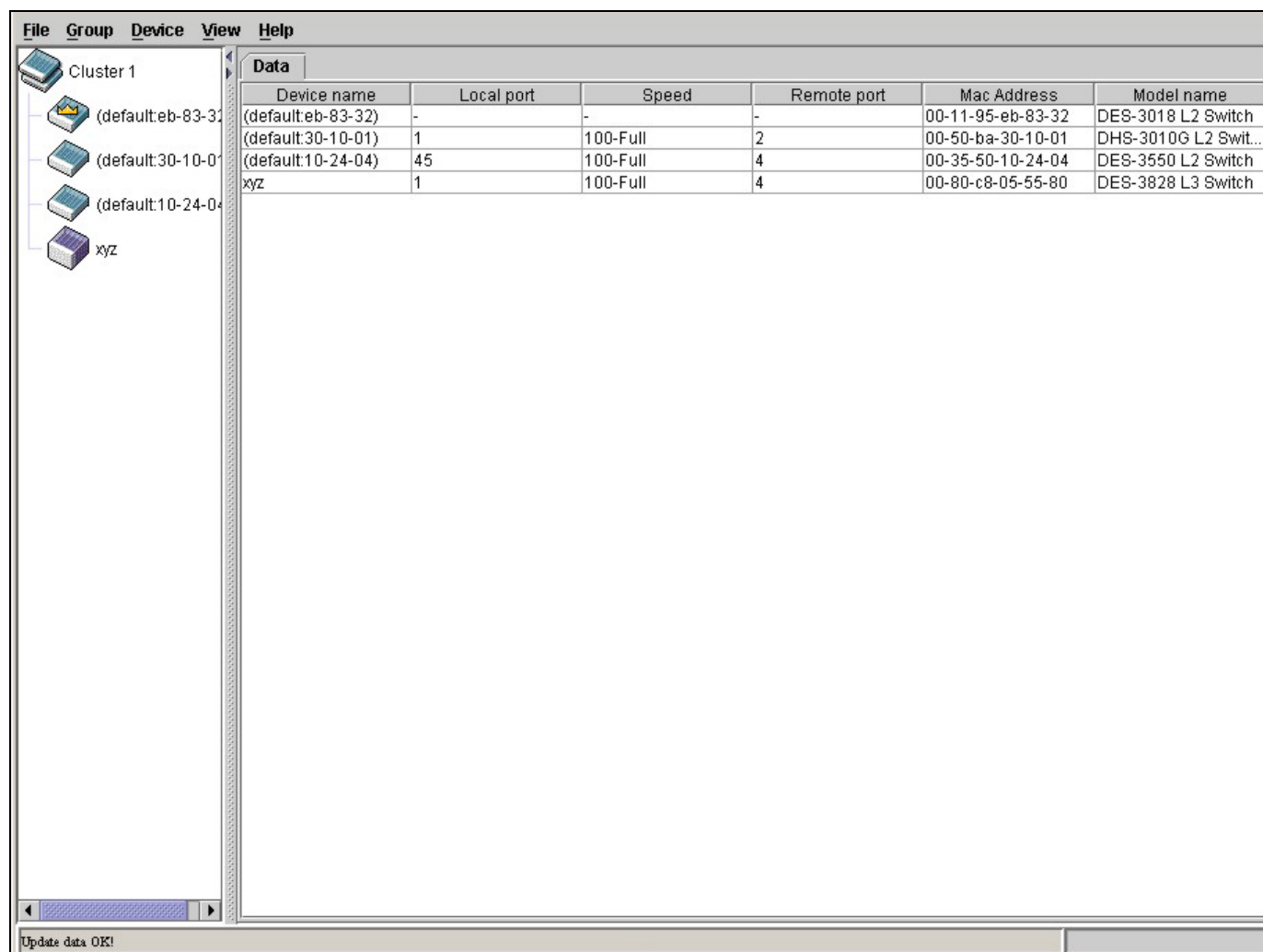

Figure 6- 37. Single IP Management window - Tree View

The Tree View window holds the following information under the Data tab:

Parameter	Description
Device Name	This field will display the Device Name of the switches in the SIM group configured by the user. If no Device Name is configured by the name, it will be given the name default and tagged with the last six digits of the MAC Address to identify it.
Local Port	Displays the number of the physical port on the CS that the MS or CaS is connected to. The CS will have no entry in this field.
Speed	Displays the connection speed between the CS and the MS or CaS.
Remote Port	Displays the number of the physical port on the MS or CaS that the CS is connected to. The CS will have no entry in this field.
MAC Address	Displays the MAC Address of the corresponding Switch.
Model Name	Displays the full Model Name of the corresponding Switch.

To view the **Topology Map**, click the View menu in the toolbar and then Topology, which will produce the following screen. The **Topology View** will refresh itself periodically (20 seconds by default).

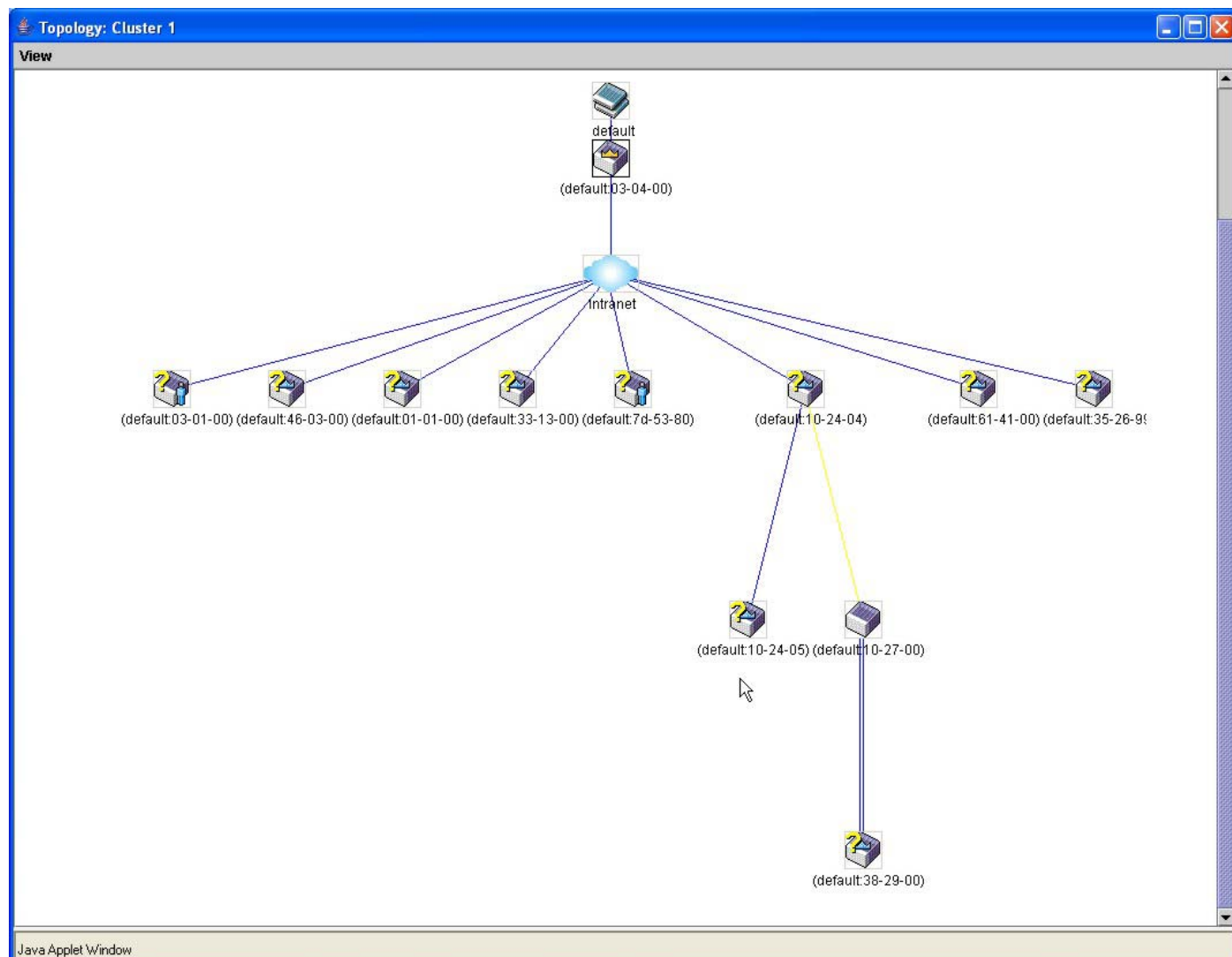













Figure 6- 38. Topology view

This screen will display how the devices within the Single IP Management Group are connected to other groups and devices. Possible icons in this screen are as follows:

Icon	Description
	Group
	Layer 2 commander switch
	Layer 3 commander switch
	Commander switch of other group
	Layer 2 member switch.
	Layer 3 member switch
	Member switch of other group

	Layer 2 candidate switch
	Layer 3 candidate switch
	Unknown device
	Non-SIM devices

Tool Tips

In the Topology view window, the mouse plays an important role in configuration and in viewing device information. Setting the mouse cursor over a specific device in the topology window (tool tip) will display the same information about a specific device as the Tree view does. See the window below for an example.

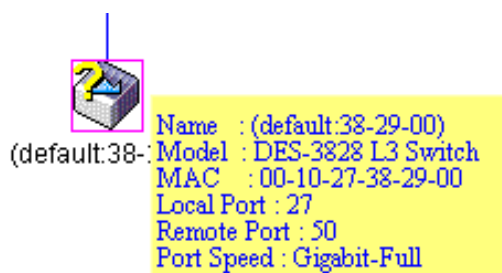

Figure 6- 39. Device Information Utilizing the Tool Tip

Setting the mouse cursor over a line between two devices will display the connection speed between the two devices, as shown below.

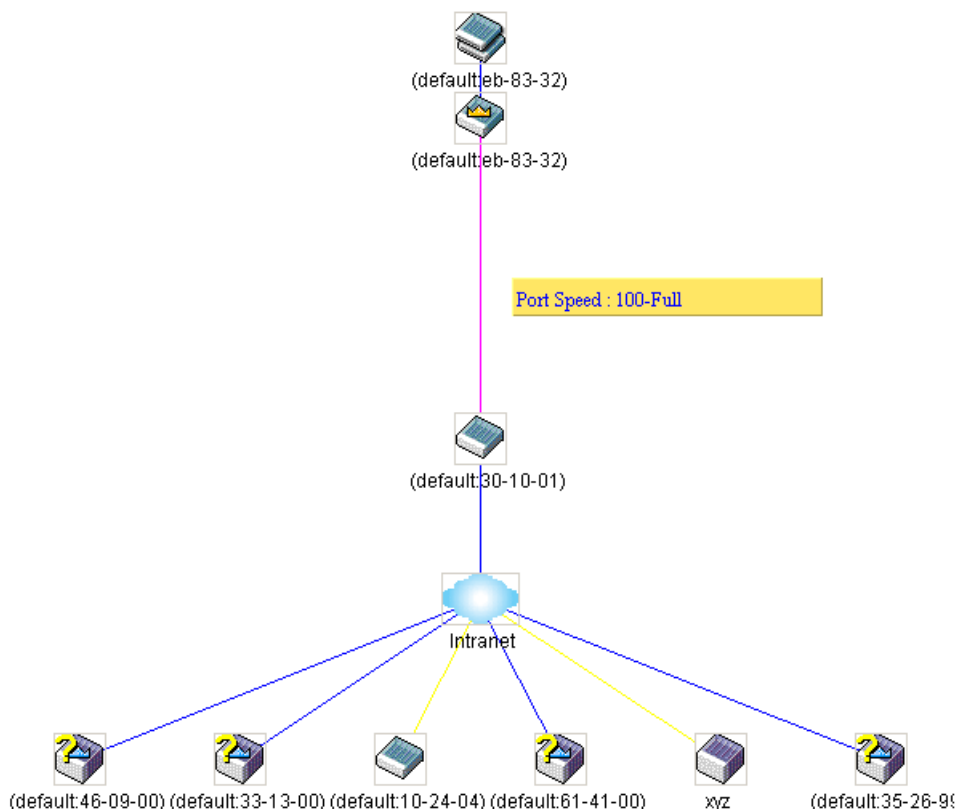

Figure 6- 40. Port Speed Utilizing the Tool Tip

Right Click

Right clicking on a device will allow the user to perform various functions, depending on the role of the Switch in the SIM group and the icon associated with it.

Group Icon



Figure 6- 41. Right Clicking a Group Icon

The following options may appear for the user to configure:

- **Collapse** - to collapse the group that will be represented by a single icon.
- **Expand** - to expand the SIM group, in detail.
- **Property** - to pop up a window to display the group information.

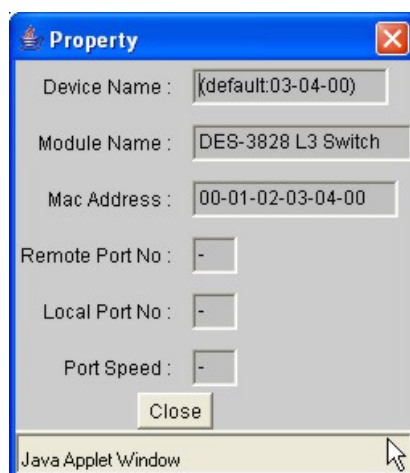

Figure 6- 42. Property window

Commander Switch Icon

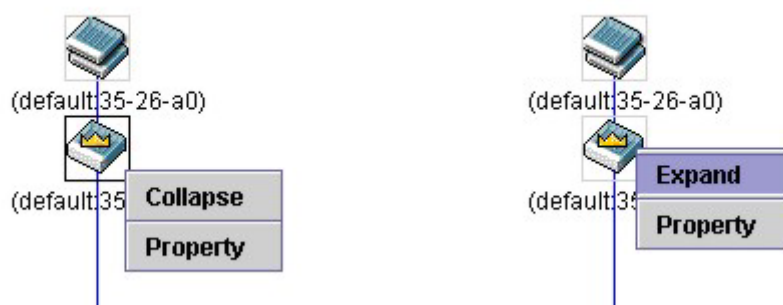

Figure 6- 43. Right Clicking a Commander Icon

The following options may appear for the user to configure:

- **Collapse** - to collapse the group that will be represented by a single icon.

- **Expand** - to expand the SIM group, in detail.
- **Property** - to pop up a window to display the group information.

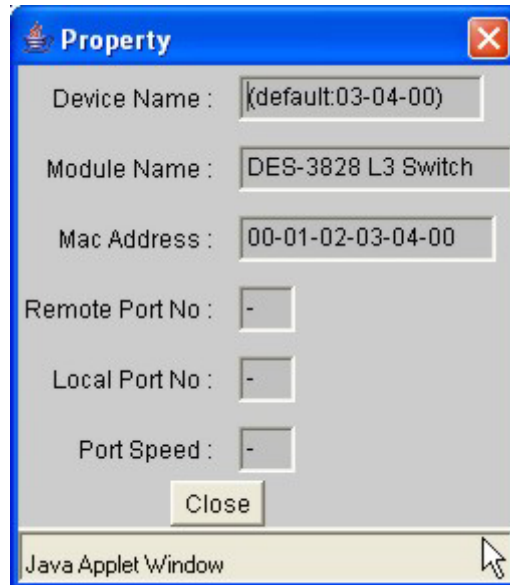

Figure 6- 44. Property window

Member Switch Icon

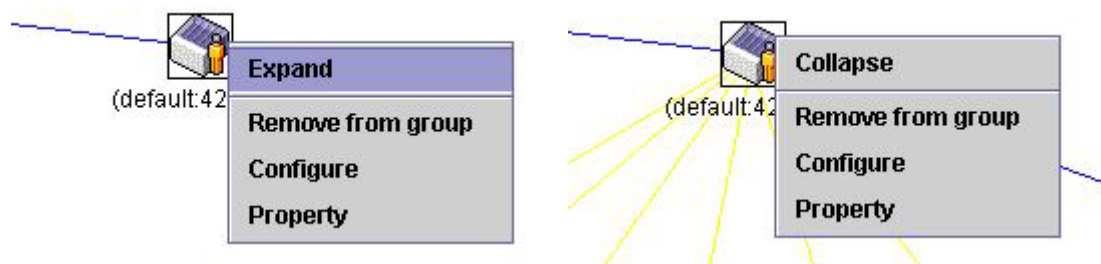

Figure 6- 45. Right Clicking a Member icon

The following options may appear for the user to configure:

- **Collapse** - to collapse the group that will be represented by a single icon.
- **Expand** - to expand the SIM group, in detail.
- **Remove from group** - remove a member from a group.
- **Configure** - launch the web management to configure the Switch.
- **Property** - to pop up a window to display the device information.

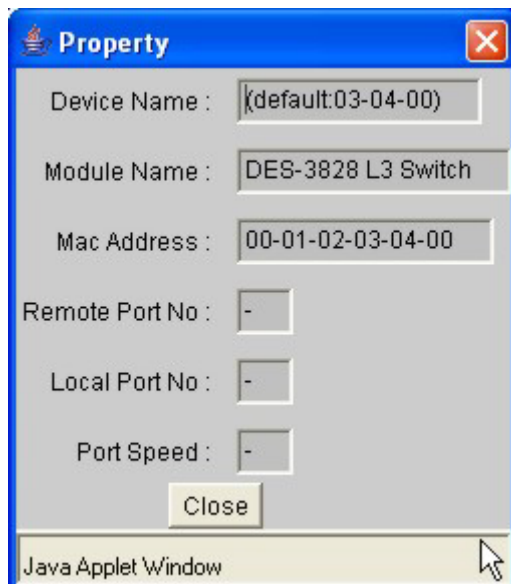

Figure 6- 46. Property window

Candidate Switch Icon

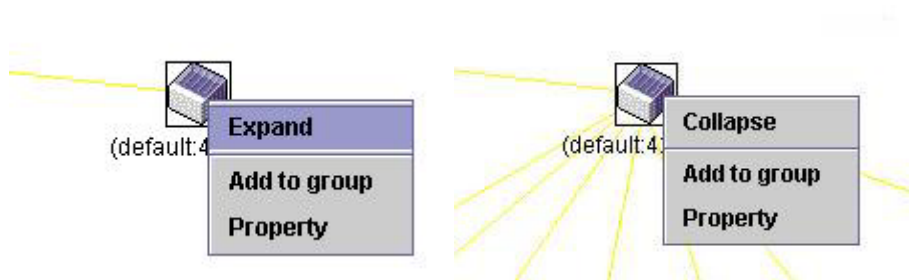

Figure 6- 47. Right Clicking a Candidate icon

The following options may appear for the user to configure:

- **Collapse** - to collapse the group that will be represented by a single icon.
- **Expand** - to expand the SIM group, in detail.
- **Add to group** - add a candidate to a group. Clicking this option will reveal the following screen for the user to enter a password for authentication from the Candidate Switch before being added to the SIM group. Click OK to enter the password or Cancel to exit the window.



Figure 6- 48. Input password window.

- **Property** - to pop up a window to display the device information, as shown below.

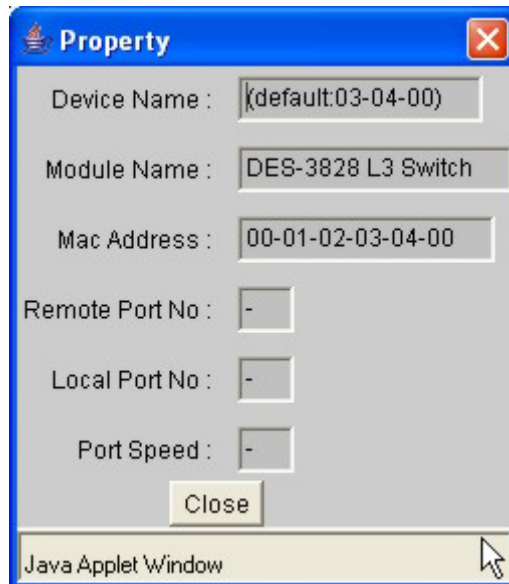

Figure 6- 49. Device Property window.

This window holds the following information:

Parameter	Description
Device Name	This field will display the Device Name of the switches in the SIM group configured by the user. If no Device Name is configured by the name, it will be given the name default and tagged with the last six digits of the MAC Address to identify it.
Module Name	Displays the full module name of the switch that was right-clicked.
MAC Address	Displays the MAC Address of the corresponding Switch.
Remote Port No.	Displays the number of the physical port on the MS or CaS that the CS is connected to. The CS will have no entry in this field.
Local Port No.	Displays the number of the physical port on the CS that the MS or CaS is connected to. The CS will have no entry in this field.
Port Speed	Displays the connection speed between the CS and the MS or CaS

Click **Close** to close the **Property** window.

Menu Bar

The **Single IP Management** window contains a menu bar for device configurations, as seen below.



Figure 6- 50. Menu Bar of the Topology View

The five menus on the menu bar are as follows.

File

- **Print Setup** - will view the image to be printed.
- **Print Topology** - will print the topology map.
- **Preference** - will set display properties, such as polling interval, and the views to open at SIM startup.

Group

- **Add to group** - add a candidate to a group. Clicking this option will reveal the following screen for the user to enter a password for authentication from the Candidate Switch before being added to the SIM group. Click OK to enter the password or Cancel to exit the window.

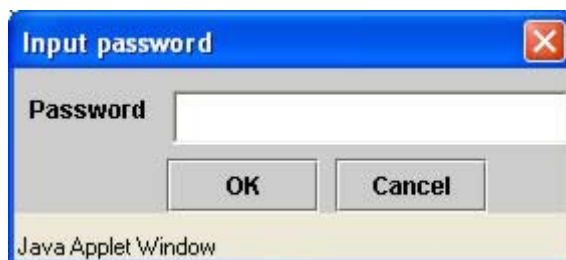

Figure 6- 51. Input password window.

- **Remove from Group** - remove an MS from the group.

Device

- **Configure** - will open the web manager for the specific device.

View

- **Refresh** - update the views with the latest status.
- **Topology** - display the Topology view.

Help

- **About** - Will display the SIM information, including the current SIM version.



NOTE: Upon this firmware release, some functions of the SIM can only be configured through the Command Line Interface. See the ***DES-3800 CLI Manual*** for more information on SIM and its configurations.

Firmware Upgrade

This screen is used to upgrade firmware from the Commander Switch to the Member Switch. To access the following window, click **Administration > Single IP Management Settings > Firmware Upgrade**. Member Switches will be listed in the table and will be specified by **Port** (port on the CS where the MS resides), **MAC Address**, **Model Name** and **Version**. To specify a certain Switch for firmware download, click its corresponding check box under the **Port** heading. To update the firmware, enter the **Server IP Address** where the firmware resides and enter the **Path/Filename** of the firmware. Click **Download** to initiate the file transfer.

Firmware Upgrade			
Port	MAC Address	Model Name	Version
Server IP Address		0	0
		0	0
Path \ Filename			
Download			

Figure 6- 52. Firmware Upgrade window

Configuration File Backup/Restore

This screen is used to upgrade configuration files from the Commander Switch to the Member Switch using a TFTP server. Member Switches will be listed in the table and will be specified by **Port** (port on the CS where the MS resides), **MAC Address**, **Model Name** and **Version**. To specify a certain Switch for upgrading configuration files, click its corresponding radio button under the **Port** heading. To update the configuration file, enter the **Server IP Address** where the file resides and enter the **Path/Filename** of the configuration file. Click **Download** to initiate the file transfer from a TFTP server to the Switch. Click **Upload** to backup the configuration file to a TFTP server. To access the following window, click **Administration > Single IP Management Settings > Configuration Backup/Restore**.

Configuration File Backup/Restore			
Port	MAC Address	Model Name	Version
Server IP Address		0	0
		0	0
Path \ Filename			
Upload Download			

Figure 6- 53. Configuration File Backup/Restore window

Upload Log File

The following window is used to upload log files from SIM member switches to a specified PC. To view this window click **Administration > Single IP Management > Upload Log File**. To upload a log file, enter the IP address of the SIM member switch and then enter a path on your PC where you wish to save this file. Click **Upload** to initiate the file transfer.

Upload Log File			
Port	MAC Address	Model Name	Version
Server IP Address		0	0
		0	0
Path \ Filename			
Upload			

Figure 6- 54. Upload Log File

Section 7

Layer 2 Features

VLAN

Trunking

IGMP Snooping

Spanning Tree

Forwarding

The following section will aid the user in configuring security functions for the Switch. The Switch includes various functions for VLAN, Trunking, IGMP Snooping, Spanning Tree, and Forwarding, all discussed in detail in the following section.

VLANs

Understanding IEEE 802.1p Priority

Priority tagging is a function defined by the IEEE 802.1p standard designed to provide a means of managing traffic on a network where many different types of data may be transmitted simultaneously. It is intended to alleviate problems associated with the delivery of time critical data over congested networks. The quality of applications that are dependent on such time critical data, such as video conferencing, can be severely and adversely affected by even very small delays in transmission.

Network devices that are in compliance with the IEEE 802.1p standard have the ability to recognize the priority level of data packets. These devices can also assign a priority label or tag to packets. Compliant devices can also strip priority tags from packets. This priority tag determines the packet's degree of expeditiousness and determines the queue to which it will be assigned.

Priority tags are given values from 0 to 7 with 0 being assigned to the lowest priority data and 7 assigned to the highest. The highest priority tag 7 is generally only used for data associated with video or audio applications, which are sensitive to even slight delays, or for data from specified end users whose data transmissions warrant special consideration.

The Switch allows you to further tailor how priority tagged data packets are handled on your network. Using queues to manage priority tagged data allows you to specify its relative priority to suit the needs of your network. There may be circumstances where it would be advantageous to group two or more differently tagged packets into the same queue. Generally, however, it is recommended that the highest priority queue, Queue 7, be reserved for data packets with a priority value of 7. Packets that have not been given any priority value are placed in Queue 0 and thus given the lowest priority for delivery.

Strict mode and weighted round robin system are employed on the Switch to determine the rate at which the queues are emptied of packets. The ratio used for clearing the queues is 4:1. This means that the highest priority queue, Queue 7, will clear 4 packets for every 1 packet cleared from Queue 0.

Remember, the priority queue settings on the Switch are for all ports, and all devices connected to the Switch will be affected. This priority queuing system will be especially beneficial if your network employs switches with the capability of assigning priority tags.

VLAN Description

A Virtual Local Area Network (VLAN) is a network topology configured according to a logical scheme rather than the physical layout. VLANs can be used to combine any collection of LAN segments into an autonomous user group that appears as a single LAN. VLANs also logically segment the network into different broadcast domains so that packets are forwarded only between ports within the VLAN. Typically, a VLAN corresponds to a particular subnet, although not necessarily.

VLANs can enhance performance by conserving bandwidth, and improve security by limiting traffic to specific domains.

A VLAN is a collection of end nodes grouped by logic instead of physical location. End nodes that frequently communicate with each other are assigned to the same VLAN, regardless of where they are physically on the network. Logically, a VLAN can be equated to a broadcast domain, because broadcast packets are forwarded to only members of the VLAN on which the broadcast was initiated.

Notes About VLANs on the DES-3800 Series

No matter what basis is used to uniquely identify end nodes and assign these nodes VLAN membership, packets cannot cross VLANs without a network device performing a routing function between the VLANs.

The DES-3800 Series supports IEEE 802.1Q VLANs and Port-Based VLANs. The port untagging function can be used to remove the 802.1Q tag from packet headers to maintain compatibility with devices that are tag-unaware.

The Switch's default is to assign all ports to a single 802.1Q VLAN named "default."

The "default" VLAN has a VID = 1.

The member ports of Port-based VLANs may overlap, if desired.

IEEE 802.1Q VLANs

Some relevant terms:

- **Tagging** - The act of putting 802.1Q VLAN information into the header of a packet.
- **Untagging** - The act of stripping 802.1Q VLAN information out of the packet header.
- **Ingress port** - A port on a switch where packets are flowing into the Switch and VLAN decisions must be made.
- **Egress port** - A port on a switch where packets are flowing out of the Switch, either to another switch or to an end station, and tagging decisions must be made.

IEEE 802.1Q (tagged) VLANs are implemented on the Switch. 802.1Q VLANs require tagging, which enables them to span the entire network (assuming all switches on the network are IEEE 802.1Q-compliant).

VLANs allow a network to be segmented in order to reduce the size of broadcast domains. All packets entering a VLAN will only be forwarded to the stations (over IEEE 802.1Q enabled switches) that are members of that VLAN, and this includes broadcast, multicast and unicast packets from unknown sources.

VLANs can also provide a level of security to your network. IEEE 802.1Q VLANs will only deliver packets between stations that are members of the VLAN.

Any port can be configured as either tagging or untagging. The untagging feature of IEEE 802.1Q VLANs allows VLANs to work with legacy switches that don't recognize VLAN tags in packet headers. The tagging feature allows VLANs to span multiple 802.1Q-compliant switches through a single physical connection and allows Spanning Tree to be enabled on all ports and work normally.

The IEEE 802.1Q standard restricts the forwarding of untagged packets to the VLAN of which the receiving port is a member.

The main characteristics of IEEE 802.1Q are as follows:

- Assigns packets to VLANs by filtering.
- Assumes the presence of a single global spanning tree.
- Uses an explicit tagging scheme with one-level tagging.
- 802.1Q VLAN Packet Forwarding
- Packet forwarding decisions are made based upon the following three types of rules:
- Ingress rules - rules relevant to the classification of received frames belonging to a VLAN.
- Forwarding rules between ports - decides whether to filter or forward the packet.
- Egress rules - determines if the packet must be sent tagged or untagged.

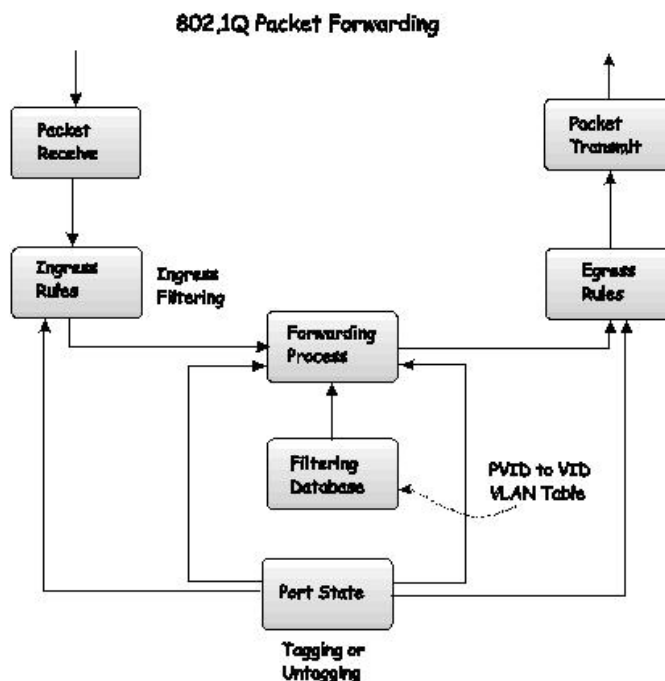

Figure 7- 1. IEEE 802.1Q Packet Forwarding

802.1Q VLAN Tags

The figure below shows the 802.1Q VLAN tag. There are four additional octets inserted after the source MAC address. Their presence is indicated by a value of 0x8100 in the EtherType field. When a packet's EtherType field is equal to 0x8100, the packet carries the IEEE 802.1Q/802.1p tag. The tag is contained in the following two octets and consists of 3 bits of user priority, 1 bit of Canonical Format Identifier (CFI - used for encapsulating Token Ring packets so they can be carried across Ethernet backbones), and 12 bits of VLAN ID (VID). The 3 bits of user priority are used by 802.1p. The VID is the VLAN identifier and is used by the 802.1Q standard. Because the VID is 12 bits long, 4094 unique VLANs can be identified.

The tag is inserted into the packet header making the entire packet longer by 4 octets. All of the information originally contained in the packet is retained.

IEEE 802.1Q Tag

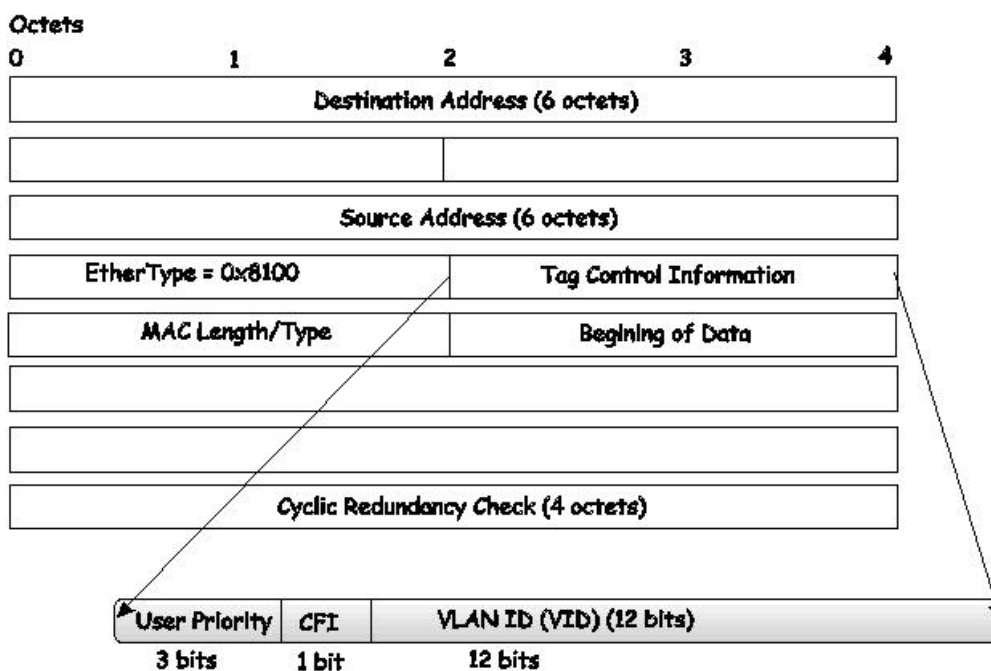

Figure 7- 2. IEEE 802.1Q Tag

The EtherType and VLAN ID are inserted after the MAC source address, but before the original EtherType/Length or Logical Link Control. Because the packet is now a bit longer than it was originally, the Cyclic Redundancy Check (CRC) must be recalculated.

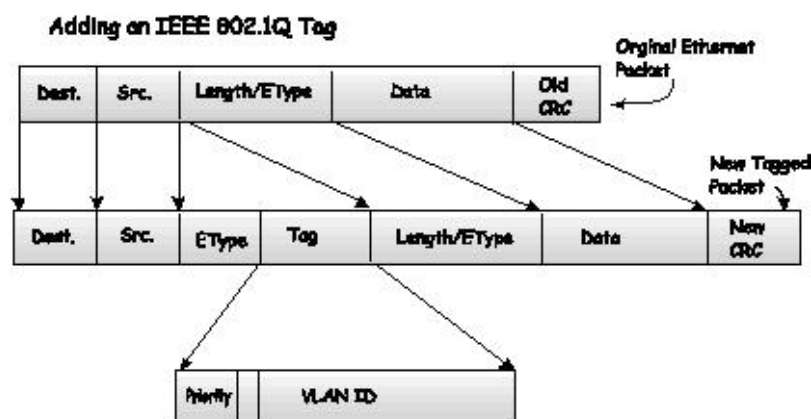

Figure 7- 3. Adding an IEEE 802.1Q Tag

Port VLAN ID

Packets that are tagged (are carrying the 802.1Q VID information) can be transmitted from one 802.1Q compliant network device to another with the VLAN information intact. This allows 802.1Q VLANs to span network devices (and indeed, the entire network, if all network devices are 802.1Q compliant).

Unfortunately, not all network devices are 802.1Q compliant. These devices are referred to as tag-unaware. 802.1Q devices are referred to as tag-aware.

Prior to the adoption of 802.1Q VLANs, port-based and MAC-based VLANs were in common use. These VLANs relied upon a Port VLAN ID (PVID) to forward packets. A packet received on a given port would be assigned that port's PVID and then be forwarded to the port that corresponded to the packet's destination address (found in the Switch's forwarding table). If the PVID of the port that received the packet is different from the PVID of the port that is to transmit the packet, the Switch will drop the packet.

Within the Switch, different PVIDs mean different VLANs (remember that two VLANs cannot communicate without an external router). So, VLAN identification based upon the PVIDs cannot create VLANs that extend outside a given switch (or switch stack).

Every physical port on a switch has a PVID. 802.1Q ports are also assigned a PVID, for use within the Switch. If no VLANs are defined on the Switch, all ports are then assigned to a default VLAN with a PVID equal to 1. Untagged packets are assigned the PVID of the port on which they were received. Forwarding decisions are based upon this PVID, in so far as VLANs are concerned. Tagged packets are forwarded according to the VID contained within the tag. Tagged packets are also assigned a PVID, but the PVID is not used to make packet-forwarding decisions, the VID is.

Tag-aware switches must keep a table to relate PVIDs within the Switch to VIDs on the network. The Switch will compare the VID of a packet to be transmitted to the VID of the port that is to transmit the packet. If the two VIDs are different, the Switch will drop the packet. Because of the existence of the PVID for untagged packets and the VID for tagged packets, tag-aware and tag-unaware network devices can coexist on the same network.

A switch port can have only one PVID, but can have as many VIDs as the Switch has memory in its VLAN table to store them.

Because some devices on a network may be tag-unaware, a decision must be made at each port on a tag-aware device before packets are transmitted - should the packet to be transmitted have a tag or not? If the transmitting port is connected to a tag-unaware device, the packet should be untagged. If the transmitting port is connected to a tag-aware device, the packet should be tagged.

Tagging and Untagging

Every port on an 802.1Q compliant switch can be configured as tagging or untagging.

Ports with tagging enabled will put the VID number, priority and other VLAN information into the header of all packets that flow into and out of it. If a packet has previously been tagged, the port will not alter the packet, thus keeping the VLAN information intact. Other 802.1Q compliant devices on the network to make packet-forwarding decisions can then use the VLAN information in the tag.

Ports with untagging enabled will strip the 802.1Q tag from all packets that flow into and out of those ports. If the packet doesn't have an 802.1Q VLAN tag, the port will not alter the packet. Thus, all packets received by and forwarded by an untagging port

will have no 802.1Q VLAN information. (Remember that the PVID is only used internally within the Switch). Untagging is used to send packets from an 802.1Q-compliant network device to a non-compliant network device.

Ingress Filtering

A port on a switch where packets are flowing into the Switch and VLAN decisions must be made is referred to as an ingress port. If ingress filtering is enabled for a port, the Switch will examine the VLAN information in the packet header (if present) and decide whether or not to forward the packet.

If the packet is tagged with VLAN information, the ingress port will first determine if the ingress port itself is a member of the tagged VLAN. If it is not, the packet will be dropped. If the ingress port is a member of the 802.1Q VLAN, the Switch then determines if the destination port is a member of the 802.1Q VLAN. If it is not, the packet is dropped. If the destination port is a member of the 802.1Q VLAN, the packet is forwarded and the destination port transmits it to its attached network segment.

If the packet is not tagged with VLAN information, the ingress port will tag the packet with its own PVID as a VID (if the port is a tagging port). The switch then determines if the destination port is a member of the same VLAN (has the same VID) as the ingress port. If it does not, the packet is dropped. If it has the same VID, the packet is forwarded and the destination port transmits it on its attached network segment.

This process is referred to as ingress filtering and is used to conserve bandwidth within the Switch by dropping packets that are not on the same VLAN as the ingress port at the point of reception. This eliminates the subsequent processing of packets that will just be dropped by the destination port.

Default VLANs

The Switch initially configures one VLAN, VID = 1, called "default." The factory default setting assigns all ports on the Switch to the "default." As new VLANs are configured in Port-based mode, their respective member ports are removed from the "default."

Packets cannot cross VLANs. If a member of one VLAN wants to connect to another VLAN, the link must be through an external router.



NOTE: If no VLANs are configured on the Switch, then all packets will be forwarded to any destination port. Packets with unknown source addresses will be flooded to all ports. Broadcast and multicast packets will also be flooded to all ports.

An example is presented below:

VLAN Name	VID	Switch Ports
System (default)	1	5, 6, 7, 8, 21, 22, 23, 24
Engineering	2	9, 10, 11, 12
Marketing	3	13, 14, 15, 16
Finance	4	17, 18, 19, 20
Sales	5	1, 2, 3, 4

Figure 7- 4. VLAN Example - Assigned Ports

Port-based VLANs

Port-based VLANs limit traffic that flows into and out of switch ports. Thus, all devices connected to a port are members of the VLAN(s) the port belongs to, whether there is a single computer directly connected to a switch, or an entire department.

On port-based VLANs, NICs do not need to be able to identify 802.1Q tags in packet headers. NICs send and receive normal Ethernet packets. If the packet's destination lies on the same segment, communications take place using normal Ethernet protocols. Even though this is always the case, when the destination for a packet lies on another switch port, VLAN considerations come into play to decide if the packet gets dropped by the Switch or delivered.

VLAN Segmentation

Take for example a packet that is transmitted by a machine on Port 1 that is a member of VLAN 2. If the destination lies on another port (found through a normal forwarding table lookup), the Switch then looks to see if the other port (Port 10) is a member of VLAN 2 (and can therefore receive VLAN 2 packets). If Port 10 is not a member of VLAN 2, then the packet will be dropped by the Switch and will not reach its destination. If Port 10 is a member of VLAN 2, the packet will go through. This selective

forwarding feature based on VLAN criteria is how VLANs segment networks. The key point being that Port 1 will only transmit on VLAN 2.

Network resources such as printers and servers however, can be shared across VLANs. This is achieved by setting up overlapping VLANs. That is ports can belong to more than one VLAN group. For example, setting VLAN 1 members to ports 1, 2, 3, and 4 and VLAN 2 members to ports 1, 5, 6, and 7. Port 1 belongs to two VLAN groups. Ports 8, 9, and 10 are not configured to any VLAN group. This means ports 8, 9, and 10 are in the same VLAN group.

VLAN and Trunk Groups

The members of a trunk group have the same VLAN setting. Any VLAN setting on the members of a trunk group will apply to the other member ports.



NOTE: In order to use VLAN segmentation in conjunction with port trunk groups, you can first set the port trunk group(s), and then you may configure VLAN settings. If you wish to change the port trunk grouping with VLANs already in place, you will not need to reconfigure the VLAN settings after changing the port trunk group settings. VLAN settings will automatically change in conjunction with the change of the port trunk group settings.

Guest VLANs

On 802.1x security enabled networks, there is a need for non 802.1x supported devices to gain limited access to the network, due to lack of the proper 802.1x software or incompatible devices, such as computers running Windows 98 or lower operating systems, or the need for guests to gain access to the network without full authorization. To supplement these circumstances, this switch now implements Guest 802.1x VLANs. These VLANs should have limited access rights and features separate from other VLANs on the network.

To implement Guest 802.1x VLANs, the user must first create a VLAN on the network with limited rights and then enable it as an 802.1x guest VLAN. Then the administrator must configure the guest accounts accessing the Switch to be placed in a Guest VLAN when trying to access the Switch. Upon initial entry to the Switch, the client wishing services on the Switch will need to be authenticated by a remote RADIUS Server or local authentication on the Switch to be placed in a fully operational VLAN. If authenticated and the authenticator possesses the VLAN placement information, that client will be accepted into the fully operational target VLAN and normal switch functions will be open to the client. If the authenticator does not have target VLAN placement information, the client will be returned to its originating VLAN. Yet, if the client is denied authentication by the authenticator, it will be placed in the Guest VLAN where it has limited rights and access. The adjacent figure should give the user a better understanding of the Guest VLAN process.

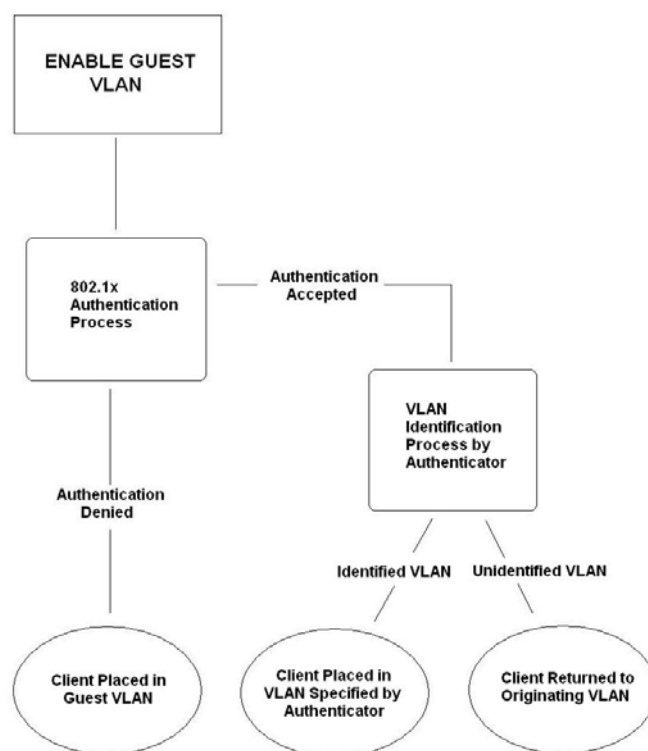

Figure 7- 5. Guest VLAN Authentication Process

Limitations Using the Guest VLAN

1. Guest VLANs are only supported for port-based VLANs. MAC-based VLANs cannot undergo this procedure.
2. Ports supporting Guest VLANs cannot be GVRP enabled and vice versa.
3. A port cannot be a member of a Guest VLAN and a static VLAN simultaneously.
4. Once a client has been accepted into the target VLAN, it can no longer access the GuestVLAN.
5. If a port is a member of multiple VLANs, it cannot become a member of the Guest VLAN.

Double VLANs

Double or Q-in-Q VLANs allow network providers to expand their VLAN configurations to place customer VLANs within a larger inclusive VLAN, which adds a new layer to the VLAN configuration. This basically lets large ISP's create L2 Virtual Private Networks and also create transparent LANs for their customers, which will connect two or more customer LAN points without over-complicating configurations on the client's side. Not only will over-complication be avoided, but also now the administrator has over 4000 VLANs in which over 4000 VLANs can be placed, therefore greatly expanding the VLAN network and enabling greater support of customers utilizing multiple VLANs on the network.

Double VLANs are basically VLAN tags placed within existing IEEE 802.1Q VLANs which we will call SPVIDs (Service Provider VLAN IDs). These VLANs are marked by a TPID (Tagged Protocol ID), configured in hex form to be encapsulated within the VLAN tag of the packet. This identifies the packet as double-tagged and segregates it from other VLANs on the network, therefore creating a hierarchy of VLANs within a single packet.

Here is an example Double VLAN tagged packet.

Destination Address	Source Address	SPVLAN (TPID + Service Provider VLAN Tag)	802.1Q CEVLAN Tag (TPID + Customer VLAN Tag)	Ether Type	Payload
---------------------	----------------	---	--	------------	---------

Consider the example below:

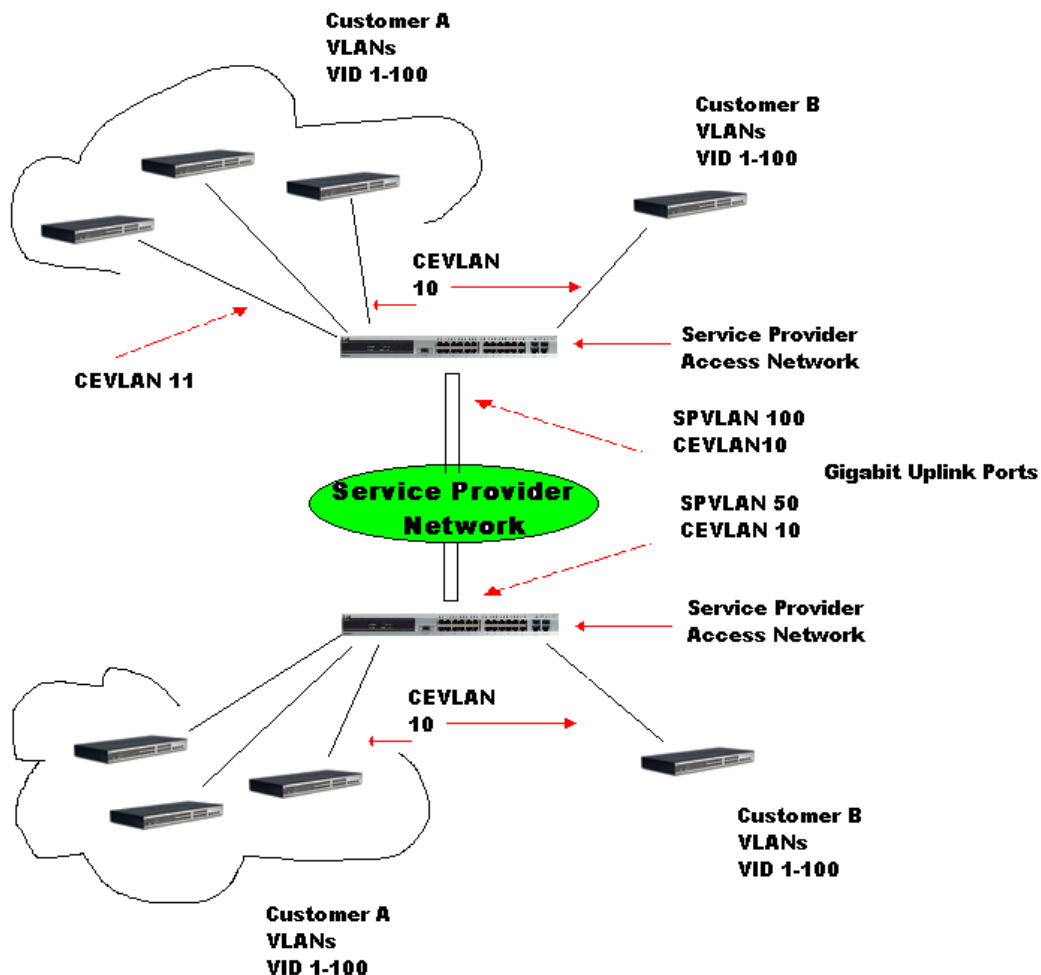

Figure 7- 6. Double VLAN Example

In this example, the Service Provider Access Network switch (Provider edge switch) is the device creating and configuring Double VLANs. Both CEVLANs (Customer VLANs), 10 and 11, are tagged with the SPVID 100 on the Service Provider Access Network and therefore belong to one VLAN on the Service Provider's network, thus being a member of two VLANs. In this way, the Customer can retain its normal VLAN and the Service Provider can congregate multiple Customer VLANs within one SPVLAN, thus greatly regulating traffic and routing on the Service Provider switch. This information is then routed to the Service Provider's main network and regarded there as one VLAN, with one set of protocols and one routing behavior.

Regulations for Double VLANs

Some rules and regulations apply with the implementation of the Double VLAN procedure.

1. All ports must be configured for the SPVID and its corresponding TPID on the Service Provider's edge switch.
2. All ports must be configured as Access Ports or Uplink ports. Access ports can only be Ethernet ports while Uplink ports must be Gigabit ports.
3. Provider Edge switches must allow frames of at least 1522 bytes or more, due to the addition of the SPVID tag.
4. Access Ports must be an un-tagged port of the service provider VLANs. Uplink Ports must be a tagged port of the service provider VLANs.
5. The switch cannot have both double and normal VLANs co-existing. Once the change of VLAN is made, all Access Control lists are cleared and must be reconfigured.
6. Once Double VLANs are enabled, GVRP must be disabled.
7. All packets sent from the CPU to the Access ports must be untagged.
8. The following functions will not operate when the switch is in Double VLAN mode:
 - Guest VLANs
 - Web-based Access Control
 - IP Multicast Routing
 - GVRP
 - All Regular 802.1Q VLAN functions

Static VLAN Entry

In the **L2 Features** folder, click **VLAN > Static VLAN Entry** to open the following window:



Current 802.1Q Static VLANs Entries				
VLAN ID	VLAN name	Ports	Advertisement	Delete
<u>1</u>	default	1-28	Enabled	X
<u>2</u>	trinity	24-28	Disabled	X

Figure 7- 7. Current 802.1Q Static VLANs Entries window

The **Current 802.1Q Static VLAN Entries** window lists all previously configured VLANs by VLAN ID and VLAN Name. To delete an existing 802.1Q VLAN, click the corresponding **X** button under the **Delete** heading.

To create a new 802.1Q VLAN, click the **Add** button in the **802.1Q Static VLANs** window. A new window will appear, as shown below, to configure the port settings and to assign a unique name and number to the new VLAN. See the table below for a description of the parameters in the new window.

802.1Q Static VLANs														
VID	VLAN Name													Advertisement
<input type="text"/>	<input type="text"/>													Disabled <input type="button" value="v"/>
Port Settings	1	2	3	4	5	6	7	8	9	10	11	12	13	14
Tag	<input checked="" type="checkbox"/>	<input checked="" type="checkbox"/>	<input checked="" type="checkbox"/>	<input checked="" type="checkbox"/>	<input checked="" type="checkbox"/>	<input checked="" type="checkbox"/>	<input checked="" type="checkbox"/>	<input checked="" type="checkbox"/>	<input checked="" type="checkbox"/>	<input checked="" type="checkbox"/>	<input checked="" type="checkbox"/>	<input checked="" type="checkbox"/>	<input checked="" type="checkbox"/>	<input checked="" type="checkbox"/>
None	<input type="radio"/>	<input type="radio"/>	<input type="radio"/>	<input type="radio"/>	<input type="radio"/>	<input type="radio"/>	<input type="radio"/>	<input type="radio"/>	<input type="radio"/>	<input type="radio"/>	<input type="radio"/>	<input type="radio"/>	<input type="radio"/>	<input type="radio"/>
Egress	<input type="radio"/>	<input type="radio"/>	<input type="radio"/>	<input type="radio"/>	<input type="radio"/>	<input type="radio"/>	<input type="radio"/>	<input type="radio"/>	<input type="radio"/>	<input type="radio"/>	<input type="radio"/>	<input type="radio"/>	<input type="radio"/>	<input type="radio"/>
Forbidden	<input type="radio"/>	<input type="radio"/>	<input type="radio"/>	<input type="radio"/>	<input type="radio"/>	<input type="radio"/>	<input type="radio"/>	<input type="radio"/>	<input type="radio"/>	<input type="radio"/>	<input type="radio"/>	<input type="radio"/>	<input type="radio"/>	<input type="radio"/>
Port Settings	15	16	17	18	19	20	21	22	23	24	25	26	27	28
Tag	<input checked="" type="checkbox"/>	<input checked="" type="checkbox"/>	<input checked="" type="checkbox"/>	<input checked="" type="checkbox"/>	<input checked="" type="checkbox"/>	<input checked="" type="checkbox"/>	<input checked="" type="checkbox"/>	<input checked="" type="checkbox"/>	<input checked="" type="checkbox"/>	<input checked="" type="checkbox"/>	<input checked="" type="checkbox"/>	<input checked="" type="checkbox"/>	<input checked="" type="checkbox"/>	<input checked="" type="checkbox"/>
None	<input type="radio"/>	<input type="radio"/>	<input type="radio"/>	<input type="radio"/>	<input type="radio"/>	<input type="radio"/>	<input type="radio"/>	<input type="radio"/>	<input type="radio"/>	<input type="radio"/>	<input type="radio"/>	<input type="radio"/>	<input type="radio"/>	<input type="radio"/>
Egress	<input type="radio"/>	<input type="radio"/>	<input type="radio"/>	<input type="radio"/>	<input type="radio"/>	<input type="radio"/>	<input type="radio"/>	<input type="radio"/>	<input type="radio"/>	<input type="radio"/>	<input type="radio"/>	<input type="radio"/>	<input type="radio"/>	<input type="radio"/>
Forbidden	<input type="radio"/>	<input type="radio"/>	<input type="radio"/>	<input type="radio"/>	<input type="radio"/>	<input type="radio"/>	<input type="radio"/>	<input type="radio"/>	<input type="radio"/>	<input type="radio"/>	<input type="radio"/>	<input type="radio"/>	<input type="radio"/>	<input type="radio"/>
<input type="button" value="Apply"/>														
Show All Static VLAN Entries														

Figure 7- 8. 802.1Q Static VLAN window - Add

To return to the 802.1Q Static VLANs window, click the [Show All Static VLAN Entries](#) link. To change an existing 802.1Q VLAN entry, click the **Modify** button of the corresponding entry to modify. A new menu will appear to configure the port settings and to assign a unique name and number to the new VLAN. See the table below for a description of the parameters in the new menu.



NOTE: The Switch supports up to 4k static VLAN entries.

802.1Q Static VLANs														
VID	VLAN Name													Advertisement
2	trinity													Disabled <input type="button" value="v"/>
Port Settings	1	2	3	4	5	6	7	8	9	10	11	12	13	14
Tag	<input checked="" type="checkbox"/>	<input checked="" type="checkbox"/>	<input checked="" type="checkbox"/>	<input checked="" type="checkbox"/>	<input checked="" type="checkbox"/>	<input checked="" type="checkbox"/>	<input checked="" type="checkbox"/>	<input checked="" type="checkbox"/>	<input checked="" type="checkbox"/>	<input checked="" type="checkbox"/>	<input checked="" type="checkbox"/>	<input checked="" type="checkbox"/>	<input checked="" type="checkbox"/>	<input checked="" type="checkbox"/>
None	<input type="radio"/>	<input type="radio"/>	<input type="radio"/>	<input type="radio"/>	<input type="radio"/>	<input type="radio"/>	<input type="radio"/>	<input type="radio"/>	<input type="radio"/>	<input type="radio"/>	<input type="radio"/>	<input type="radio"/>	<input type="radio"/>	<input type="radio"/>
Egress	<input type="radio"/>	<input type="radio"/>	<input type="radio"/>	<input type="radio"/>	<input type="radio"/>	<input type="radio"/>	<input type="radio"/>	<input type="radio"/>	<input type="radio"/>	<input type="radio"/>	<input type="radio"/>	<input type="radio"/>	<input type="radio"/>	<input type="radio"/>
Forbidden	<input type="radio"/>	<input type="radio"/>	<input type="radio"/>	<input type="radio"/>	<input type="radio"/>	<input type="radio"/>	<input type="radio"/>	<input type="radio"/>	<input type="radio"/>	<input type="radio"/>	<input type="radio"/>	<input type="radio"/>	<input type="radio"/>	<input type="radio"/>
Port Settings	15	16	17	18	19	20	21	22	23	24	25	26	27	28
Tag	<input checked="" type="checkbox"/>	<input checked="" type="checkbox"/>	<input checked="" type="checkbox"/>	<input checked="" type="checkbox"/>	<input checked="" type="checkbox"/>	<input checked="" type="checkbox"/>	<input checked="" type="checkbox"/>	<input checked="" type="checkbox"/>	<input checked="" type="checkbox"/>	<input checked="" type="checkbox"/>	<input checked="" type="checkbox"/>	<input checked="" type="checkbox"/>	<input checked="" type="checkbox"/>	<input checked="" type="checkbox"/>
None	<input type="radio"/>	<input type="radio"/>	<input type="radio"/>	<input type="radio"/>	<input type="radio"/>	<input type="radio"/>	<input type="radio"/>	<input type="radio"/>	<input type="radio"/>	<input type="radio"/>	<input type="radio"/>	<input type="radio"/>	<input type="radio"/>	<input type="radio"/>
Egress	<input type="radio"/>	<input type="radio"/>	<input type="radio"/>	<input type="radio"/>	<input type="radio"/>	<input type="radio"/>	<input type="radio"/>	<input type="radio"/>	<input type="radio"/>	<input type="radio"/>	<input type="radio"/>	<input type="radio"/>	<input type="radio"/>	<input type="radio"/>
Forbidden	<input type="radio"/>	<input type="radio"/>	<input type="radio"/>	<input type="radio"/>	<input type="radio"/>	<input type="radio"/>	<input type="radio"/>	<input type="radio"/>	<input type="radio"/>	<input type="radio"/>	<input type="radio"/>	<input type="radio"/>	<input type="radio"/>	<input type="radio"/>
<input type="button" value="Apply"/>														
Show All Static VLAN Entries														

Figure 7- 9. 802.1Q Static VLANs - Modify

The following fields can then be set in either the **Add** or **Modify** 802.1Q Static VLANs windows:

Parameter	Description
VID (VLAN ID)	Allows the entry of a VLAN ID in the Add window, or displays the VLAN ID of an existing VLAN in the Modify window. VLANs can be identified by either the VID or the VLAN name.
VLAN Name	Allows the entry of a name for the new VLAN in the Add window, or for editing the VLAN name in the Modify window.
Advertisement	Enabling this function will allow the Switch to send out GVRP packets to outside sources, notifying that they may join the existing VLAN.
Port Settings	Allows an individual port to be specified as member of a VLAN.
Tag	Specifies the port as either 802.1Q tagging or 802.1Q untagged. Checking the box will designate the port as Tagged.
None	Allows an individual port to be specified as a non-VLAN member.
Egress	Select this to specify the port as a static member of the VLAN. Egress member ports are ports that will be transmitting traffic for the VLAN. These ports can be either tagged or untagged.
Forbidden	Select this to specify the port as not being a member of the VLAN and that the port is forbidden from becoming a member of the VLAN dynamically.

Click **Apply** to implement changes made.

GVRP Setting

In the **L2 Features** menu, open the **VLAN** folder and click **GVRP Settings**. The **GVRP Settings** window, shown left, allows you to determine whether the Switch will share its VLAN configuration information with other GARP VLAN Registration Protocol (GVRP) enabled switches. In addition, Ingress Checking can be used to limit traffic by filtering incoming packets whose PVID does not match the PVID of the port. Results can be seen in the table under the configuration settings, as seen below.

GVRP Settings						
From	To	GVRP	Ingress Check	Acceptable Frame Type	PVID	Apply
Port 1	Port 1	Disabled	Enabled	Admit_All		Apply

GVRP Table				
Port	PVID	GVRP	Ingress Check	Acceptable Frame Type
1	1	Disabled	Enabled	All Frames
2	1	Disabled	Enabled	All Frames
3	1	Disabled	Enabled	All Frames
4	1	Disabled	Enabled	All Frames
5	1	Disabled	Enabled	All Frames
6	1	Disabled	Enabled	All Frames
7	1	Disabled	Enabled	All Frames
8	1	Disabled	Enabled	All Frames
9	1	Disabled	Enabled	All Frames
10	1	Disabled	Enabled	All Frames
11	1	Disabled	Enabled	All Frames
12	1	Disabled	Enabled	All Frames
13	1	Disabled	Enabled	All Frames
14	1	Disabled	Enabled	All Frames
15	1	Disabled	Enabled	All Frames
16	1	Disabled	Enabled	All Frames
17	1	Disabled	Enabled	All Frames
18	1	Disabled	Enabled	All Frames
19	1	Disabled	Enabled	All Frames
20	1	Disabled	Enabled	All Frames
21	1	Disabled	Enabled	All Frames
22	1	Disabled	Enabled	All Frames
23	1	Disabled	Enabled	All Frames
24	1	Disabled	Enabled	All Frames
25	1	Disabled	Enabled	All Frames
26	1	Disabled	Enabled	All Frames
27	1	Disabled	Enabled	All Frames
28	1	Disabled	Enabled	All Frames

Figure 7- 10. 802.1Q Port Settings window

The following fields can be set:

Parameter	Description
From/To	These two fields allow you to specify the range of ports that will be included in the Port-based VLAN that you are creating using the 802.1Q Port Settings window.
GVRP	The Group VLAN Registration Protocol (GVRP) enables the port to dynamically become a member of a VLAN. GVRP is <i>Disabled</i> by default.
Ingress Check	This field can be toggled using the space bar between <i>Enabled</i> and <i>Disabled</i> . <i>Enabled</i> enables the port to compare the VID tag of an incoming packet with the PVID number assigned to the port. If the two are different, the port filters (drops) the packet. <i>Disabled</i> disables ingress filtering. Ingress Checking is <i>Disabled</i> by default.
PVID	The read-only field in the 802.1Q Port Table shows the current PVID assignment for each port, which may be manually assigned to a VLAN when created in the 802.1Q Port Settings table. The Switch's default is to assign all ports to the default VLAN with a VID of 1. The PVID is used by the port to tag outgoing, untagged packets, and to make filtering decisions about incoming packets. If the port is specified to accept only tagged frames - as tagging, and an untagged packet is forwarded to the port for transmission, the port will add an 802.1Q tag using the PVID to write the VID in the tag. When the packet arrives at its destination, the receiving device will use the PVID to make VLAN forwarding decisions. If the port receives a packet, and Ingress filtering is enabled, the port will compare the VID of the incoming packet to its PVID. If the two are unequal, the port will drop the packet. If the two are equal, the port will receive the packet.
Acceptable Frame Type	This field denotes the type of frame that will be accepted by the port. The user may choose between <i>Tagged Only</i> , which means only VLAN tagged frames will be accepted, and <i>Admit_All</i> , which mean both tagged and untagged frames will be accepted. <i>Admit_All</i> is enabled by default.

Click **Apply** to implement changes made.

Guest VLAN

In the **L2** menu, open the **VLAN** folder and click **Guest VLAN Settings**, which will display the following window for the user to configure. Remember, to set a guest 802.1x VLAN, the user must first configure a normal VLAN which can be enabled here for Guest VLAN status.

Figure 7- 11. Guest VLAN Configuration window

The following fields may be modified to enable the guest 802.1x VLAN:

Parameter	Description
VLAN Name	Enter the pre-configured VLAN name to create as a guest 802.1x VLAN.
Operation	Allows the user to enable or disable ports for the 802.1x VLAN, using the Port List stated below.
Port List	Set the port list of ports to be enabled for the guest 802.1x VLAN using the pull down menus.

Click **Apply** to implement the guest 802.1x VLAN. Once properly configured, the **Guest VLAN Name** and associated ports will be listed in the lower part of the window, as seen in the example above.

Double VLAN

In the **L2 Features** menu, open the **VLAN** folder and click **Double VLAN Settings**, which will display the following window for the user to configure.

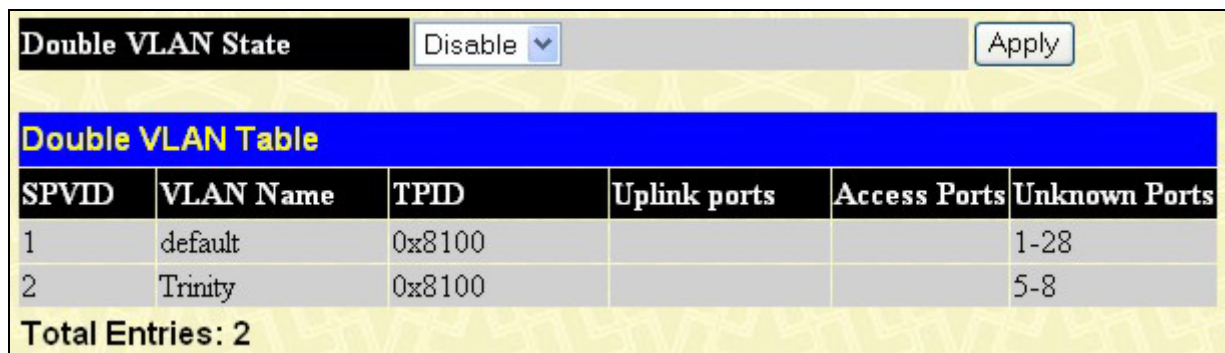

Figure 7- 12. Double VLAN Table (disabled)

To configure the Double VLAN, change the Double VLAN state to **Enable** which will alter the window to look like the one below, which can be configured for Double VLANs.

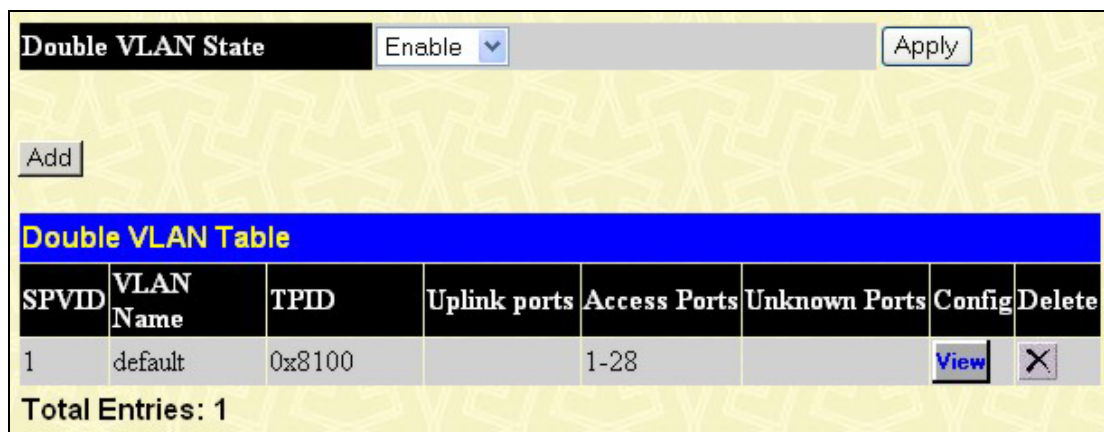

Figure 7- 13 Double VLAN Table (enabled)

Parameters shown in the previous window are explained below:

Parameter	Description
Double VLAN State	Use the pull-down menu to enable or disable the Double VLAN function on this Switch. Enabling the Double VLAN will return all previous VLAN configurations to the factory default settings.
SPVID	The VLAN ID number of this potential Service Provider VLAN.
VLAN Name	The name of the VLAN on the Switch.
TPID	The tagged protocol ID of the corresponding VLAN that will be used in identification of this potential Double VLAN, written in hex form.
Uplink Ports	These ports are set as uplink ports on the Switch. Uplink ports are for connecting Switch VLANs to the Service Provider VLANs on a remote source. Only gigabit ports can be configured as uplink ports.
Access Ports	These are the ports that are set as access ports on the Switch. Access ports are for connecting Switch VLANs to customer VLANs. Gigabit ports cannot be configured as access ports.
Unknown Ports	These are the ports that are a part of the VLAN but have yet to be defined as Access or Uplink ports.
Config	Click the View button to configure this VLAN to be a Double VLAN. This button will provide the user with a new window to aid in configuration of the Double VLAN.
Delete	Click the corresponding X to remove this VLAN from Double VLAN configuration.

To create a Double VLAN, click the **Add** button, revealing the following window for the user to configure.

Figure 7- 14. Double VLAN Creation

To create a Double VLAN, enter the following parameters and click Apply.

Parameter	Description
VLAN Name	Enter the pre-configured VLAN name to create as a Double VLAN.
SPVID	Enter the VID for the Service Provider VLAN with an integer between 1 and 4094.
TPID	Enter the TPID in hex form to aid in packet identification of the Service Provider VLAN.

Click **Apply** to implement changes made.

To configure the parameters for a previously created Service Provider VLAN, click the **View** button of the corresponding SPVID in the **Double VLAN Table** as shown in Figure 7-12. The following window will appear for the user to configure.

Figure 7- 15. Double VLAN Configuration

To configure a Double VLAN, enter the following parameters and click **Apply**.

Parameter	Description
VLAN Name	The name of the pre-configured VLAN name to be configured.
Operation	Allows one of the following three acts to be performed: <i>Add ports</i> – Will allow users to add ports to this Service Provider VLAN using the Port List field below. <i>Delete ports</i> – Will allow users to remove ports from the Service Provider VLAN configured, using the Port List field below. <i>Config TPID</i> – Will allow users to configure the Tagged Protocol ID of the Service Provider VLAN, in hex form.
Port Type	Allows the user to choose the type of port being utilized by the Service Provider VLAN. The user may choose: <i>Access</i> - Access ports are for connecting Switch VLANs to customer VLANs. Gigabit ports cannot be configured as access ports. <i>Uplink</i> - Uplink ports are for connecting Switch VLANs to the Provider VLANs on a remote source. Only gigabit ports can be configured as uplink ports.
Port List	Use the From and To fields to set a list of ports to be placed in, or removed from, the Service Provider VLAN.
TPID	The tagged protocol ID. Enter the new TPID in hex form to aid in packet identification of the Service Provider VLAN.

Trunking

Understanding Port Trunk Groups

Port trunk groups are used to combine a number of ports together to make a single high-bandwidth data pipeline. DES-3800 Series supports up to 32 port trunk groups with 2 to 8 ports in each group. A potential bit rate of 8000 Mbps can be achieved.

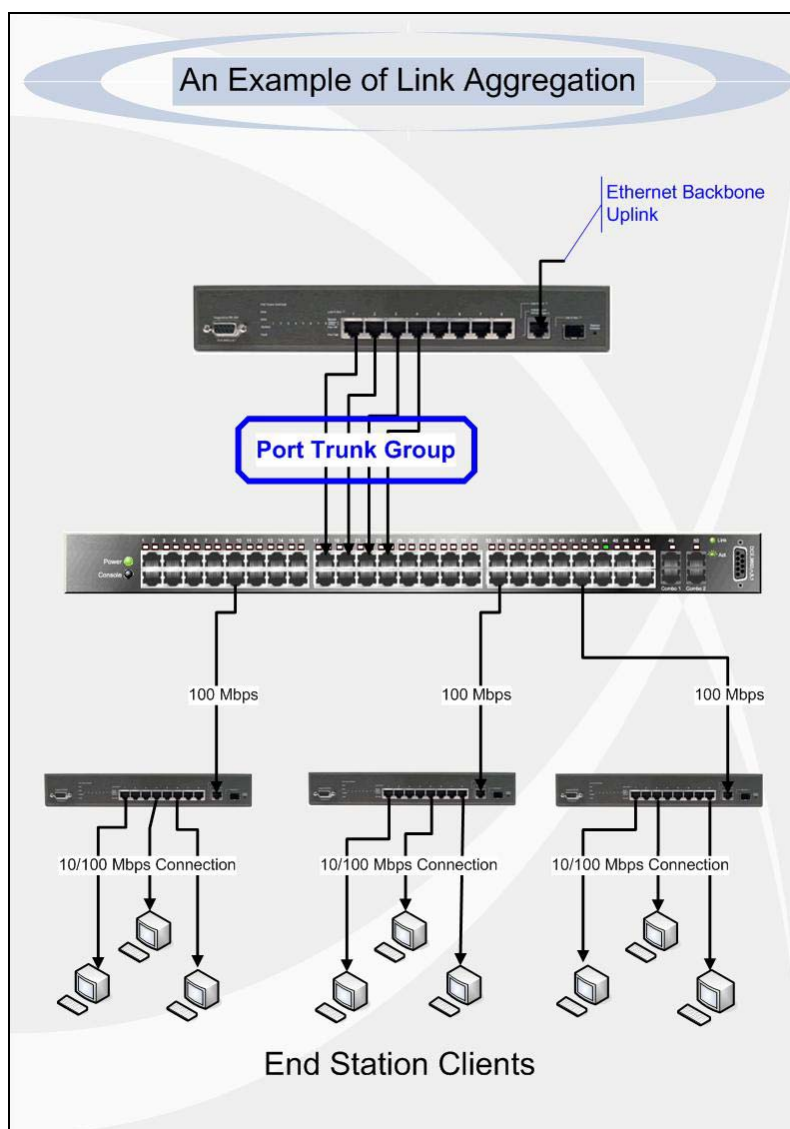

Figure 7- 16. Example of Port Trunk Group

The Switch treats all ports in a trunk group as a single port. Data transmitted to a specific host (destination address) will always be transmitted over the same port in a trunk group. This allows packets in a data stream to arrive in the same order they were sent.



NOTE: If any ports within the trunk group become disconnected, packets intended for the disconnected port will be load shared among the other unlinked ports of the link aggregation group.

Link aggregation allows several ports to be grouped together and to act as a single link. This gives a bandwidth that is a multiple of a single link's bandwidth.

Link aggregation is most commonly used to link a bandwidth intensive network device or devices, such as a server, to the backbone of a network.

The Switch allows the creation of up to 32 link aggregation groups, each group consisting of 2 to 8 links (ports). The aggregated links must be contiguous (they must have sequential port numbers) except the four (optional) Gigabit ports, which can only belong to a single link aggregation group. All of the ports in the group must be members of the same VLAN, and their STP status, static multicast, traffic control; traffic segmentation and 802.1p default priority configurations must be identical. Port locking, port

mirroring and 802.1X must not be enabled on the trunk group. Further, the aggregated links must all be of the same speed and should be configured as full duplex.

The Master Port of the group is to be configured by the user, and all configuration options, including the VLAN configuration that can be applied to the Master Port, are applied to the entire link aggregation group.

Load balancing is automatically applied to the ports in the aggregated group, and a link failure within the group causes the network traffic to be directed to the remaining links in the group.

The Spanning Tree Protocol will treat a link aggregation group as a single link, on the switch level. On the port level, the STP will use the port parameters of the Master Port in the calculation of port cost and in determining the state of the link aggregation group. If two redundant link aggregation groups are configured on the Switch, STP will block one entire group; in the same way STP will block a single port that has a redundant link.

Link Aggregation

To configure port trunking, click on the **Link Aggregation** hyperlink in the **Trunking** folder under **L2 Features** to bring up the following window:

Link Aggregation Group Entries			
Group ID	Ports	State	Delete
1	27-28	Enabled	<input type="checkbox"/>

Figure 7- 17. Port Link Aggregation Group window

To configure port trunk groups, click the **Add** button to add a new trunk group and use the **Link Aggregation Group Configuration** window (see example below) to set up trunk groups. To modify a port trunk group, click the Hyperlinked Group ID. To delete a port trunk group, click the corresponding under the Delete heading in the **Link Aggregation Group Entries** table.

Link Aggregation Group Configuration														
Group ID	<input type="text"/>													
Type	LACP													
State	Disabled													
Master Port	Port 1													
Member Ports	1	2	3	4	5	6	7	8	9	10	11	12	13	14
	<input type="checkbox"/>	<input type="checkbox"/>	<input type="checkbox"/>	<input type="checkbox"/>	<input type="checkbox"/>	<input type="checkbox"/>	<input type="checkbox"/>	<input type="checkbox"/>	<input type="checkbox"/>	<input type="checkbox"/>	<input type="checkbox"/>	<input type="checkbox"/>	<input type="checkbox"/>	<input type="checkbox"/>
Member Ports	15	16	17	18	19	20	21	22	23	24	25	26	27	28
	<input type="checkbox"/>	<input type="checkbox"/>	<input type="checkbox"/>	<input type="checkbox"/>	<input type="checkbox"/>	<input type="checkbox"/>	<input type="checkbox"/>	<input type="checkbox"/>	<input type="checkbox"/>	<input type="checkbox"/>	<input type="checkbox"/>	<input type="checkbox"/>	<input type="checkbox"/>	<input type="checkbox"/>
Flooding Port	<input checked="" type="checkbox"/>													
Apply														
<p>Note(1): It is only valid to set up at most 8 member ports of any one trunk group and a port can be a member of only one trunk group at a time.</p> <p>Show All Link Aggregation Group Entries</p>														

Figure 7- 18. Link Aggregation Group Configuration – Add

Link Aggregation Group Configuration														
Group ID	1													
Type	LACP													
State	Enabled													
Master Port	Port 27													
Member Ports	1	2	3	4	5	6	7	8	9	10	11	12	13	14
	<input type="checkbox"/>	<input type="checkbox"/>	<input type="checkbox"/>	<input type="checkbox"/>	<input type="checkbox"/>	<input type="checkbox"/>	<input type="checkbox"/>	<input type="checkbox"/>	<input type="checkbox"/>	<input type="checkbox"/>	<input type="checkbox"/>	<input type="checkbox"/>	<input type="checkbox"/>	<input type="checkbox"/>
	15	16	17	18	19	20	21	22	23	24	25	26	27	28
Active Ports	1	2	3	4	5	6	7	8	9	10	11	12	13	14
	<input type="checkbox"/>	<input type="checkbox"/>	<input type="checkbox"/>	<input type="checkbox"/>	<input type="checkbox"/>	<input type="checkbox"/>	<input type="checkbox"/>	<input type="checkbox"/>	<input type="checkbox"/>	<input type="checkbox"/>	<input type="checkbox"/>	<input type="checkbox"/>	<input type="checkbox"/>	<input type="checkbox"/>
	15	16	17	18	19	20	21	22	23	24	25	26	27	28
Floding Port	X													
<input type="button" value="Apply"/>														
<p>Note(1): It is only valid to set up at most 8 member ports of any one trunk group and a port can be a member of only one trunk group at a time.</p> <p>Show All Link Aggregation Group Entries</p>														

Figure 7- 19. Link Aggregation Group Configuration - Modify

The user-changeable parameters are as follows:

Parameter	Description
Group ID	Select an ID number for the group, between 1 and 32.
State	Trunk groups can be toggled between <i>Enabled</i> and <i>Disabled</i> . This is used to turn a port trunking group on or off. This is useful for diagnostics, to quickly isolate a bandwidth intensive network device or to have an absolute backup aggregation group that is not under automatic control.
Master Port	Choose the Master Port for the trunk group using the pull-down menu.
Member Ports	Choose the members of a trunked group. Up to eight ports per group can be assigned to a group.
Floding Port	A trunking group must designate one port to allow transmission of broadcasts and unknown unicasts.
Active Port	Shows the port that is currently forwarding packets.
Type	This pull-down menu allows you to select between <i>Static</i> and <i>LACP</i> (Link Aggregation Control Protocol). LACP allows for the automatic detection of links in a Port Trunking Group.

After setting the previous parameters, click **Apply** to allow your changes to be implemented. Successfully created trunk groups will be show in the **Link Aggregation Group Entries** table as seen in Figure 7-17.

LACP Port Settings

The **LACP Port Settings** window is used in conjunction with the **Link Aggregation** window to create port trunking groups on the Switch. Using the following window, the user may set which ports will be active and passive in processing and sending LACP control frames. To view this window, click **L2 Features > Trunking > LACP Port Settings**.

From	To	Mode	Apply
Port 1	Port 1	Active	Apply

LACP Port Information	
Port	Mode
1	Passive
2	Passive
3	Passive
4	Passive
5	Passive
6	Passive
7	Passive
8	Passive
9	Passive
10	Passive
11	Passive
12	Passive
13	Passive
14	Passive
15	Passive
16	Passive
17	Passive
18	Passive
19	Passive
20	Passive
21	Passive
22	Passive
23	Passive
24	Passive
25	Passive
26	Passive
27	Passive
28	Passive

Figure 7- 20. LACP Port Settings window

The user may set the following parameters:

Parameter	Description
From/To	A consecutive group of ports may be configured starting with the selected port.
Mode	<p><i>Active</i> - Active LACP ports are capable of processing and sending LACP control frames. This allows LACP compliant devices to negotiate the aggregated link so the group may be changed dynamically as needs require. In order to utilize the ability to change an aggregated port group, that is, to add or subtract ports from the group, at least one of the participating devices must designate LACP ports as active. Both devices must support LACP.</p> <p><i>Passive</i> - LACP ports that are designated as passive cannot initially send LACP control frames. In order to allow the linked port group to negotiate adjustments and make changes dynamically, one end of the connection must have "active" LACP ports (see above).</p>

After setting the previous parameters, click **Apply** to allow your changes to be implemented. The **LACP Port Table** shows which ports are active and/or passive.

IGMP

Internet Group Management Protocol (IGMP) snooping allows the Switch to recognize IGMP queries and reports sent between network stations or devices and an IGMP host. When enabled for IGMP snooping, the Switch can open or close a port to a specific device based on IGMP messages passing through the Switch.

In order to use IGMP Snooping it must first be enabled for the entire Switch (see the **DES-3800 Web Management Tool**). You may then fine-tune the settings for each VLAN using the **IGMP Snooping** link in the **L2 Features** folder. When enabled for IGMP snooping, the Switch can open or close a port to a specific multicast group member based on IGMP messages sent from the device to the IGMP host or vice versa. The Switch monitors IGMP messages and discontinues forwarding multicast packets when there are no longer hosts requesting that they continue.

IGMP Snooping

Use the **IGMP Snooping Settings** window to view **IGMP Snooping** configurations. To modify the settings, click the **Modify** button of the VLAN ID to change.

IGMP Snooping Settings				
VLAN ID	VLAN Name	State	Querier State	Modify
1	default	Disabled	Disabled	Modify
2	Trinity	Disabled	Disabled	Modify

Figure 7- 21. IGMP Snooping Settings window

Clicking the **Modify** button will open the **IGMP Snooping Settings** window, shown below:

IGMP Snooping Settings-Edit	
VLAN ID	<input type="text" value="2"/>
VLAN Name	<input type="text" value="Trinity"/>
Query Interval (1-65535 sec)	<input type="text" value="125"/>
Max Response Time (1-25 sec)	<input type="text" value="10"/>
Robustness Variable (1-255)	<input type="text" value="2"/>
Last Member Query Interval (1-25 sec)	<input type="text" value="1"/>
Host Timeout (1-16711450 sec)	<input type="text" value="260"/>
Router Timeout (1-16711450 sec)	<input type="text" value="260"/>
Leave Timer (1-16711450 sec)	<input type="text" value="2"/>
Querier State	Disabled <input type="button" value="v"/>
Querier Router Behavior	Non-Querier
State	Disabled <input type="button" value="v"/>
Fast Leave	Disabled <input type="button" value="v"/>

[Show All IGMP Snooping Entries](#)

Figure 7- 22. IGMP Snooping Settings-Edit window

The following parameters may be viewed or modified:

Parameter	Description
VLAN ID	This is the VLAN ID that, along with the VLAN Name, identifies the VLAN for which the user wishes to modify the IGMP Snooping Settings.

VLAN Name	This is the VLAN Name that, along with the VLAN ID, identifies the VLAN for which the user wishes to modify the IGMP Snooping Settings.
Query Interval	The Query Interval field is used to set the time (in seconds) between transmitting IGMP queries. Entries between 1 and 65535 seconds are allowed. Default = 125.
Max Response Time	This determines the maximum amount of time in seconds allowed before sending an IGMP response report. The Max Response Time field allows an entry between 1 and 25 (seconds). Default = 10.
Robustness Variable	Adjust this variable according to expected packet loss. If packet loss on the VLAN is expected to be high, the Robustness Variable should be increased to accommodate increased packet loss. This entry field allows an entry of 1 to 255. Default = 2.
Last Member Query Interval	This field specifies the maximum amount of time between group-specific query messages, including those sent in response to leave group messages. Default = 1.
Host Timeout	This is the maximum amount of time in seconds allowed for a host to continue membership in a multicast group without the Switch receiving a host membership report. Default = 260.
Route Timeout	This is the maximum amount of time in seconds a route is kept in the forwarding table without receiving a membership report. Default = 260.
Leave Timer	This specifies the maximum amount of time in seconds between the Switch receiving a leave group message from a host, and the Switch issuing a group membership query. If no response to the membership query is received before the Leave Timer expires, the (multicast) forwarding entry for that host is deleted.
Querier State	Choose <i>Enabled</i> to enable transmitting IGMP Query packets or <i>Disabled</i> to disable. The default is <i>Disabled</i> .
Querier Router Behavior	This read-only field describes the behavior of the router for sending query packets. <i>Querier</i> will denote that the router is sending out IGMP query packets. <i>Non-Querier</i> will denote that the router is not sending out IGMP query packets. This field will only read <i>Querier</i> when the Querier State and the State fields have been Enabled.
State	Select <i>Enabled</i> to implement IGMP Snooping. This field is <i>Disabled</i> by default.
Fast Leave	This parameter allows the user to enable the <i>Fast Leave</i> function. Enabled, this function will allow members of a multicast group to leave the group immediately (without the implementation of the Last Member Query Timer) when an IGMP Leave Report Packet is received by the Switch. The default is <i>Disabled</i> .

Click **Apply** to implement the new settings. Click the [Show All IGMP Group Entries](#) link to return to the **IGMP Snooping Settings** window.

Static Router Port Settings

A static router port is a port that has a multicast router attached to it. Generally, this router would have a connection to a WAN or to the Internet. Establishing a router port will allow multicast packets coming from the router to be propagated through the network, as well as allowing multicast messages (IGMP) coming from the network to be propagated to the router.

A router port has the following behavior:

- All IGMP Report packets will be forwarded to the router port.
- IGMP queries (from the router port) will be flooded to all ports.
- All UDP multicast packets will be forwarded to the router port. Because routers do not send IGMP reports or implement IGMP snooping, a multicast router connected to the router port of a Layer 3 switch would not be able to receive UDP data streams unless the UDP multicast packets were all forwarded to the router port.

A router port will be dynamically configured when IGMP query packets, RIPv2 multicast, DVMRP multicast or PIM-DM multicast packets are detected flowing into a port.

Open the **IGMP folder** in the **L2 Features** folder and then click on the **Static Router Port Settings** link to open the following page, as shown below.

Static Router Port Settings		
VLAN ID	VLAN Name	Modify
1	default	Modify
2	Trinity	Modify

Figure 7- 23. Static Router Ports Settings window

The previous window displays all of the current entries to the Switch's static router port table. To modify an entry, click the **Modify** button. This will open the **Static Router Ports Settings** window, as shown below.

Static Router Port Settings - Edit													
VID	2												
VLAN Name	Trinity												
Member Ports													
1	2	3	4	5	6	7	8	9	10	11	12	13	14
<input type="checkbox"/>	<input type="checkbox"/>	<input type="checkbox"/>	<input type="checkbox"/>	<input type="checkbox"/>	<input type="checkbox"/>	<input type="checkbox"/>	<input type="checkbox"/>	<input type="checkbox"/>	<input type="checkbox"/>	<input type="checkbox"/>	<input type="checkbox"/>	<input type="checkbox"/>	<input type="checkbox"/>
15	16	17	18	19	20	21	22	23	24	25	26	27	28
<input type="checkbox"/>	<input type="checkbox"/>	<input type="checkbox"/>	<input type="checkbox"/>	<input type="checkbox"/>	<input type="checkbox"/>	<input type="checkbox"/>	<input type="checkbox"/>	<input type="checkbox"/>	<input type="checkbox"/>	<input type="checkbox"/>	<input type="checkbox"/>	<input type="checkbox"/>	<input type="checkbox"/>
Apply													
Show All Static Router Port Entries													

Figure 7- 24. Static Router Ports Settings - Edit window

The following parameters can be set:

Parameter	Description
VID (VLAN ID)	This is the VLAN ID that, along with the VLAN Name, identifies the VLAN where the multicast router is attached.
VLAN Name	This is the name of the VLAN where the multicast router is attached.
Member Ports	Ports on the Switch that will have a multicast router attached to them.

Click **Apply** to implement the new settings, Click the [Show All Static Router Port Entries](#) link to return to the **Static Router Port Settings** window.

Spanning Tree

This Switch supports three versions of the Spanning Tree Protocol; 802.1d STP, 802.1w Rapid STP and 802.1s MSTP. 802.1d STP will be familiar to most networking professionals. However, since 802.1w RSTP and 802.1s MSTP has been recently introduced to D-Link managed Ethernet switches, a brief introduction to the technology is provided below followed by a description of how to set up 802.1d STP, 802.1w RSTP and 802.1s MSTP.

802.1s MSTP

Multiple Spanning Tree Protocol, or MSTP, is a standard defined by the IEEE community that allows multiple VLANs to be mapped to a single spanning tree instance, which will provide multiple pathways across the network. Therefore, these MSTP configurations will balance the traffic load, preventing wide scale disruptions when a single spanning tree instance fails. This will allow for faster convergences of new topologies for the failed instance. Frames designated for these VLANs will be processed quickly and completely throughout interconnected bridges utilizing any of the three spanning tree protocols (STP, RSTP or MSTP).

This protocol will also tag BPDU packets so receiving devices can distinguish spanning tree instances, spanning tree regions and the VLANs associated with them. An MSTI ID will classify these instances. MSTP will connect multiple spanning trees with a Common and Internal Spanning Tree (CIST). The CIST will automatically determine each MSTP region, its maximum possible extent and will appear as one virtual bridge that runs a single spanning tree. Consequentially, frames assigned to different VLANs will follow different data routes within administratively established regions on the network, continuing to allow simple and full processing of frames, regardless of administrative errors in defining VLANs and their respective spanning trees.

Each switch utilizing the MSTP on a network will have a single MSTP configuration that will have the following three attributes:

1. A configuration name defined by an alphanumeric string of up to 32 characters (defined in the **MST Configuration Identification** window in the Configuration Name field).
2. A configuration revision number (named here as a Revision Level and found in the **MST Configuration Identification** window) and;
3. A 4096-element table (defined here as a VID List in the **MST Configuration Identification** window), which will associate each of the possible 4096 VLANs supported by the Switch for a given instance.

To utilize the MSTP function on the Switch, three steps need to be taken:

1. The Switch must be set to the MSTP setting (found in the **STP Bridge Global Settings** window in the STP Version field).
2. The correct spanning tree priority for the MSTP instance must be entered (defined here as a Priority in the **STP Instance Settings** window when configuring an MSTI ID settings).
3. VLANs that will be shared must be added to the MSTP Instance ID (defined here as a VID List in the **MST Configuration Identification** window when configuring an MSTI ID settings).

802.1w Rapid Spanning Tree

The Switch implements three versions of the Spanning Tree Protocol, the Multiple Spanning Tree Protocol (MSTP) as defined by the IEEE 802.1s, the Rapid Spanning Tree Protocol (RSTP) as defined by the IEEE 802.1w specification and a version compatible with the IEEE 802.1d STP. RSTP can operate with legacy equipment implementing IEEE 802.1d, however the advantages of using RSTP will be lost.

The IEEE 802.1w Rapid Spanning Tree Protocol (RSTP) evolved from the 802.1d STP standard. RSTP was developed in order to overcome some limitations of STP that impede the function of some recent switching innovations, in particular, certain Layer 3 functions that are increasingly handled by Ethernet switches. The basic function and much of the terminology is the same as STP. Most of the settings configured for STP are also used for RSTP. This section introduces some new Spanning Tree concepts and illustrates the main differences between the two protocols.

Port Transition States

An essential difference between the three protocols is in the way ports transition to a forwarding state and in the way this transition relates to the role of the port (forwarding or not forwarding) in the topology. MSTP and RSTP combine the transition states disabled, blocking and listening used in 802.1d and creates a single state Discarding. In either case, ports do not forward packets. In the STP port transition states disabled, blocking or listening or in the RSTP/MSTP port state discarding, there is no functional difference, the port is not active in the network topology. Table 7-1 below compares how the three protocols differ regarding the port state transition.

All three protocols calculate a stable topology in the same way. Every segment will have a single path to the root bridge. All bridges listen for BPDU packets. However, BPDU packets are sent more frequently - with every Hello packet. BPDU packets are

sent even if a BPDU packet was not received. Therefore, each link between bridges is sensitive to the status of the link. Ultimately this difference results in faster detection of failed links, and thus faster topology adjustment. A drawback of 802.1d is this absence of immediate feedback from adjacent bridges.

802.1d MSTP	802.1w RSTP	802.1d STP	Forwarding	Learning
Disabled	Disabled	Disabled	No	No
Discarding	Discarding	Blocking	No	No
Discarding	Discarding	Listening	No	No
Learning	Learning	Learning	No	Yes
Forwarding	Forwarding	Forwarding	Yes	Yes

Table 7- 1. Comparing Port States

RSTP is capable of a more rapid transition to a forwarding state - it no longer relies on timer configurations - RSTP compliant bridges are sensitive to feedback from other RSTP compliant bridge links. Ports do not need to wait for the topology to stabilize before transitioning to a forwarding state. In order to allow this rapid transition, the protocol introduces two new variables: the edge port and the point-to-point (P2P) port.

Edge Port

The edge port is a configurable designation used for a port that is directly connected to a segment where a loop cannot be created. An example would be a port connected directly to a single workstation. Ports that are designated as edge ports transition to a forwarding state immediately without going through the listening and learning states. An edge port loses its status if it receives a BPDU packet, immediately becoming a normal spanning tree port.

P2P Port

A P2P port is also capable of rapid transition. P2P ports may be used to connect to other bridges. Under RSTP/MSTP, all ports operating in full-duplex mode are considered to be P2P ports, unless manually overridden through configuration.

802.1d/802.1w/802.1s Compatibility

MSTP or RSTP can interoperate with legacy equipment and is capable of automatically adjusting BPDU packets to 802.1d format when necessary. However, any segment using 802.1d STP will not benefit from the rapid transition and rapid topology change detection of MSTP or RSTP. The protocol also provides for a variable used for migration in the event that legacy equipment on a segment is updated to use RSTP or MSTP.

The Spanning Tree Protocol (STP) operates on two levels:

1. On the switch level, the settings are globally implemented.
2. On the port level, the settings are implemented on a per user-defined group of ports basis.

STP Bridge Global Settings

To open the following window, open the **Spanning Tree** folder in the **L2 Features** menu and click the **STP Bridge Global Settings** link.

STP Bridge Global Settings	
STP Status	Disabled ▾
STP Version	RSTP ▾
Hello Time(1-10 Sec)	2
Max Age(6-40 Sec)	20
Forward Delay(4-30 Sec)	15
Max Hops(1-20)	20
TX Hold Count(1-10)	3
Forwarding BPDU	Enabled ▾
Loopback Detection	Enabled ▾
LBD Recover Time(0, 60-1000000)	60
Apply	

Figure 7- 25. STP Bridge Global Settings window – RSTP (default)

STP Bridge Global Settings	
STP Status	Disabled ▾
STP Version	MSTP ▾
Max Age(6-40 Sec)	20
Forward Delay(4-30 Sec)	15
Max Hops(1-20)	20
TX Hold Count(1-10)	3
Forwarding BPDU	Enabled ▾
Loopback Detection	Enabled ▾
LBD Recover Time(0, 60-1000000)	60
Apply	

Figure 7- 26. STP Bridge Global Settings window - MSTP

STP Bridge Global Settings	
STP Status	Disabled ▾
STP Version	RSTP ▾
Hello Time(1-10 Sec)	2
Max Age(6-40 Sec)	20
Forward Delay(4-30 Sec)	15
Max Hops(1-20)	20
TX Hold Count(1-10)	3
Forwarding BPDU	Enabled ▾
Loopback Detection	Enabled ▾
LBD Recover Time(0, 60-1000000)	60
Apply	

Figure 7- 27. STP Bridge Global Settings – STP Compatible window



NOTE: The Hello Time cannot be longer than the Max. Age. Otherwise, a configuration error will occur. Observe the following formulas when setting the above parameters:

Max. Age $\leq 2 \times$ (Forward Delay - 1 second)

Max. Age $\leq 2 \times$ (Hello Time + 1 second)

The following parameters can be set:

Parameter	Description
Spanning Tree Protocol	Use the pull-down menu to enable or disable STP globally on the Switch. The default is <i>Disabled</i> .
Bridge Max Age: (6 - 40 sec)	The Max Age may be set to ensure that old information does not endlessly circulate through redundant paths in the network, preventing the effective propagation of the new information. Set by the Root Bridge, this value will aid in determining that the Switch has spanning tree configuration values consistent with other devices on the bridged LAN. If the value ages out and a BPDU has still not been received from the Root Bridge, the Switch will start sending its own BPDU to all other switches for permission to become the Root Bridge. If it turns out that your switch has the lowest Bridge Identifier, it will become the Root Bridge. The user may choose a time between 6 and 40 seconds. The default value is 20.
Bridge Hello Time: (1 - 10 sec)	The Hello Time can be set from 1 to 10 seconds. This is the interval between two transmissions of BPDU packets sent by the Root Bridge to tell all other switches that it is indeed the Root Bridge.
Bridge Forward Delay: (4 - 30 sec)	The Forward Delay can be from 4 to 30 seconds. Any port on the Switch spends this time in the listening state while moving from the blocking state to the forwarding state.
Bridge Priority (0-61440)	A Priority for the Switch can be set from 0 to 61440. This number is used in the voting process between Switches on the network to determine which Switch will be the root Switch. A low number indicates a high priority, and a high probability that this Switch will be elected as the root Switch.
Default Path Cost	This read-only field displays the protocol used in determining the default path cost per port. 802.1T will calculate this 32-bit cost value through the use of a specific formula based on the port bandwidth.
STP Version	Use the pull-down menu to choose the desired version of STP to be implemented on the Switch. There are two choices: <i>STPCompatibility</i> - Select this parameter to set the Spanning Tree Protocol (STP) globally on the switch. <i>RSTP</i> - Select this parameter to set the Rapid Spanning Tree Protocol (RSTP) globally on the Switch.
TX Hold Count (1-10)	Used to set the maximum number of Hello packets transmitted per interval. The count can be specified from 1 to 10. The default is 3.
Forwarding BPDU	This field can be <i>Enabled</i> or <i>Disabled</i> . When <i>Enabled</i> , it allows the forwarding of STP BPDU packets from other network devices. The default is Enabled.
Loopback Detection	This feature is used to temporarily shutdown a port on the Switch when a BPDU packet has been looped back to the switch. When the Switch detects its own BPDU packet coming back, it signifies a loop on the network. STP will automatically be blocked and an alert will be sent to the administrator. The LBD STP port will restart (change to discarding state) when the LBD Recover Time times out. The Loopback Detection function will only be implemented on one port at a time. The user may enable or disable this function using the pull-down menu. The default is Enabled.
LBD Recover Time	This field will set the time the STP port will wait before recovering the STP state set. 0 will denote that the LBD will never time out or restart until the administrator personally changes it. The user may also set a time between 60 and 1000000 seconds. The default is 60 seconds.



NOTE: The Loopback Detection function can only be implemented on the Switch if it is configured both on the STP Global Settings window, and on the STP Port Settings window. Enabling this feature through only one of these windows will not fully enable the Loopback Detection function.

Click **Apply** to implement changes made.

MST Configuration Identification

The following screens in the **MST Configuration Identification** window allow the user to configure a MSTI instance on the Switch. These settings will uniquely identify a multiple spanning tree instance set on the Switch. The Switch initially possesses one *CIST* or Common Internal Spanning Tree of which the user may modify the parameters for but cannot change the MSTI ID for, and cannot be deleted. To view the **MST Configuration Identification** window, click **L2 Features > Spanning Tree > MST Configuration Identification**:

MST Configuration Identification		
Configuration Name	Revision Level	
00:01:02:03:04:00	0	
MSTI ID	VID List	Delete
CIST	1-4094	X

MST Configuration Identification Settings	
Configuration Name	00:01:02:03:04:00
Revision Level(0-65535)	0

Apply

Figure 7- 28. MST Configuration Identification and Settings window

The window above contains the following information:

Parameter	Description
Configuration Name	A previously configured name set on the Switch to uniquely identify the MSTI (Multiple Spanning Tree Instance). If a configuration name is not set, this field will show the MAC address to the device running MSTP. This field can be set in the STP Bridge Global Settings window.
Revision Level	This value, along with the Configuration Name will identify the MSTP region configured on the Switch. The user may choose a value between 0-65535 with a default setting of 0.
MSTI ID	This field shows the MSTI IDs currently set on the Switch. This field will always have the CIST MSTI, which may be configured but not deleted. Clicking the hyperlinked name will open a new window for configuring parameters associated with that particular MSTI.
VID List	This field displays the VLAN IDs associated with the specific MSTI.

Clicking the **Add** button will reveal the following window to configure:

Instance ID Settings	
MSTI ID	<input type="text"/>
Type	Create ▾
VID List (1-4094)	<input type="checkbox"/> <input type="text"/>

Apply

[Show MST Configuration Table](#)

Figure 7- 29. Instance ID Settings window – Add

The user may configure the following parameters to create a MSTI in the Switch.

Parameter	Description
MSTI ID	Enter a number between 1 and 15 to set a new MSTI on the Switch.
Type	Create is selected to create a new MSTI. No other choices are available for this field when creating a new MSTI.
VID List (1-4094)	This field is used to specify the VID range from configured VLANs set on the Switch. Supported VIDs on the Switch range from ID number 1 to 4094.

Click **Apply** to implement changes made.

To configure the settings for the CIST, click on its hyperlinked name in the **MST Configuration Identification** window, which will reveal the following window to configure:

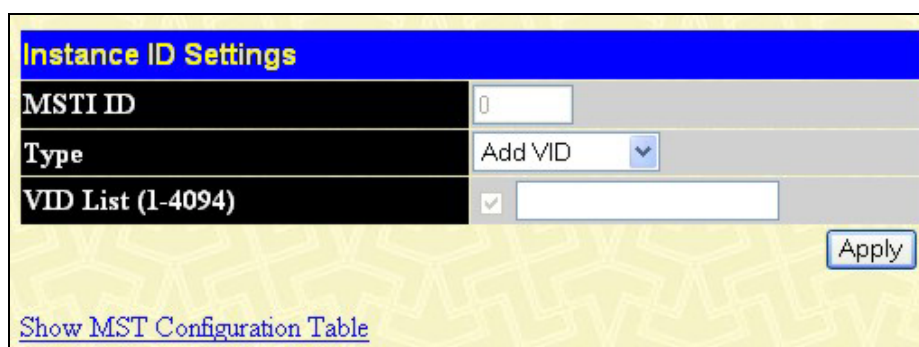

Figure 7- 30. Instance ID Settings window - CIST modify

The user may configure the following parameters to configure the CIST on the Switch.

Parameter	Description
MSTI ID	The MSTI ID of the CIST is 0 and cannot be altered.
Type	This field allows the user to choose a desired method for altering the MSTI settings. The user has 2 choices. <ul style="list-style-type: none"> • <i>Add VID</i> - Select this parameter to add VIDs to the MSTI ID, in conjunction with the VID List parameter. • <i>Remove VID</i> - Select this parameter to remove VIDs from the MSTI ID, in conjunction with the VID List parameter.
VID List (1-4094)	This field is used to specify the VID range from configured VLANs set on the Switch. Supported VIDs on the Switch range from ID number 1 to 4094. This field is inoperable when configuring the CIST.

Click **Apply** to implement changes made.

To configure the parameters for a previously set MSTI, click on its hyperlinked MSTI ID number, which will reveal the following window for configuration.



Figure 7- 31. Instance ID Settings window – modify

The user may configure the following parameters for a MSTI on the Switch.

Parameter	Description
MSTI ID	Displays the MSTI ID previously set by the user.
Type	<p>This field allows the user to choose a desired method for altering the MSTI settings. The user has four choices.</p> <ul style="list-style-type: none"> • <i>Add</i> - Select this parameter to add VIDs to the MSTI ID, in conjunction with the VID List parameter. • <i>Remove</i> - Select this parameter to remove VIDs from the MSTI ID, in conjunction with the VID List parameter.
VID List (1-4094)	This field is used to specify the VID range from configured VLANs set on the Switch that the user wishes to add to this MSTI ID. Supported VIDs on the Switch range from ID number 1 to 4094. This parameter can only be utilized if the Type chosen is <i>Add</i> or <i>Remove</i> .

Click **Apply** to implement changes made.

MSTP Port Information

This window displays the current MSTP Port Information and can be used to update the port configuration for an MSTI ID. If a loop occurs, the MSTP function will use the port priority to select an interface to put into the forwarding state. Set a higher priority value for interfaces to be selected for forwarding first. In instances where the priority value is identical, the MSTP function will implement the lowest MAC address into the forwarding state and other interfaces will be blocked. Remember that lower priority values mean higher priorities for forwarding packets. To view the following window, click **L2 Features > Spanning Tree > MSTP Port Information**:

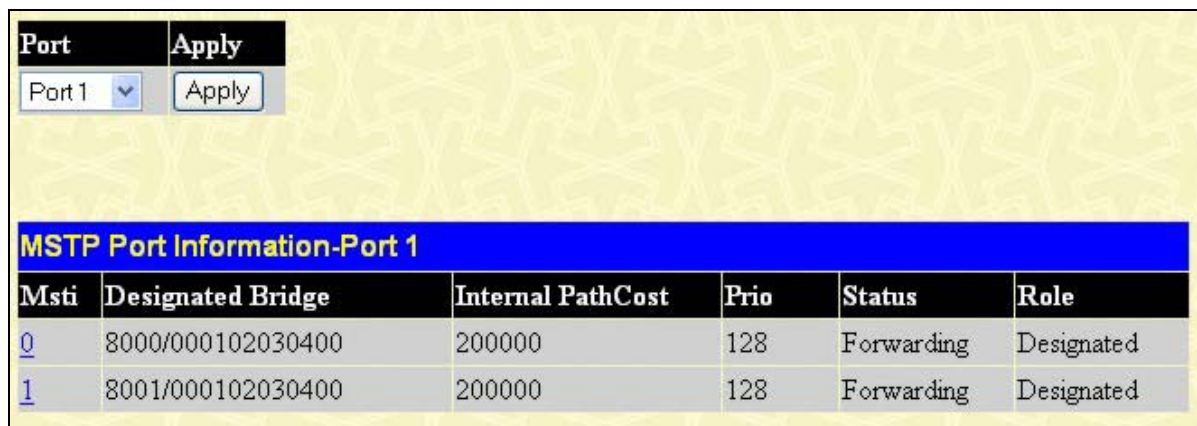

Figure 7- 32. MSTP Port Information window

To view the MSTI settings for a particular port, select the Port number, located in the top left hand corner of the screen and click **Apply**. To modify the settings for a particular MSTI Instance, click on its hyperlinked MSTI ID, which will reveal the following window.

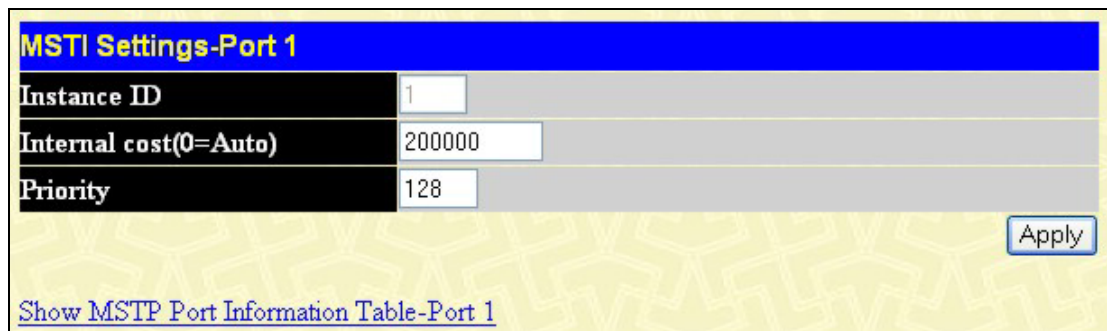

Figure 7- 33. MSTI Settings window

Parameter	Description
Instance ID	Displays the MSTI ID of the instance being configured. An entry of 0 in this field denotes the CIST (default MSTI).
Internal cost (0=Auto)	This parameter is set to represent the relative cost of forwarding packets to specified ports when an interface is selected within a STP instance. The default setting is 0 (auto). There are two options: <ul style="list-style-type: none"> • 0 (auto) - Selecting this parameter for the <i>internalCost</i> will set quickest route automatically and optimally for an interface. The default value is derived from the media speed of the interface. • value 1-2000000 - Selecting this parameter with a value in the range of 1-2000000 will set the quickest route when a loop occurs. A lower Internal cost represents a quicker transmission.
Priority	Enter a value between 0 and 240 to set the priority for the port interface. A higher priority will designate the interface to forward packets first. A lower number denotes a higher priority.

Click **Apply** to implement changes made.

STP Instance Settings

The following window displays MSTIs currently set on the Switch. To view the following table, click **L2 Features > Spanning Tree > STP Instance Settings**:

STP Instance Settings			
Instance Type	Instance Status	Instance Priority	Priority
CIST	Enabled	32768(bridge priority : 32768, sys ID ext : 0)	<input type="button" value="Modify"/>
MSTI(1)	Enabled	32769(bridge priority : 32768, sys ID ext : 1)	<input type="button" value="Modify"/>

Figure 7- 34. STP Instance Table window

The following information is displayed:

Parameter	Description
Instance Type	Displays the instance type(s) currently configured on the Switch. Each instance type is classified by a MSTI ID. CIST refers to the default MSTI configuration set on the Switch.
Instance Status	Displays the current status of the corresponding MSTI ID
Instance Priority	Displays the priority of the corresponding MSTI ID. The lowest priority will be the root bridge.

Click **Apply** to implement changes made.

Click the **Modify** button to change the priority of the MSTI. This will open the Instance ID Settings window to configure.

Instance ID Settings	
MSTI ID	<input type="text" value="0"/>
Type	Set Priority Only <input type="button" value="v"/>
Priority (0-61440)	<input type="text"/>
<input type="button" value="Apply"/>	
Show STP Instance Table	

Figure 7- 35. STP Instance Settings - modify priority window

Parameter	Description
MSTI ID	Displays the MSTI ID of the instance being modified. An entry of 0 in this field denotes the CIST (default MSTI).
Type	The Type field in this window will be permanently set to <i>Set Priority Only</i> .
Priority (0-61440)	Enter the new priority in the Priority field. The user may set a priority value between 0-61440.

Click **Apply** to implement the new priority setting.

STP Port Settings

STP can be set up on a port per port basis. To view the STP Port Settings window click **L2 Features > Spanning Tree > STP Port Settings**.

In addition to setting Spanning Tree parameters for use on the switch level, the Switch allows for the configuration of groups of ports, each port-group of which will have its own spanning tree, and will require some of its own configuration settings. An STP Group will use the switch-level parameters entered above, with the addition of Port Priority and Port Cost. An STP Group spanning tree works in the same way as the switch-level spanning tree, but the root bridge concept is replaced with a root port concept. A root port is a port of the group that is elected based on port priority and port cost, to be the connection to the network for the group. Redundant links will be blocked, just as redundant links are blocked on the switch level. The STP on the switch level blocks redundant links between switches (and similar network devices). The port level STP will block redundant links within an STP Group.

It is advisable to define an STP Group to correspond to a VLAN group of ports.

The screenshot shows the 'STP Port Settings' window. At the top, there are configuration fields: 'From' (Port 1), 'To' (Port 1), 'External Cost (0=Auto)' (0), 'Hello Time' (1), 'Migrate' (Yes), 'Edge' (False), 'P2P' (True), 'Forward BPDU' (Disabled), 'LBD' (Disabled), and 'State' (Enabled). An 'Apply' button is located at the bottom right of this section.

Below the configuration fields is the 'STP Port Settings Table' with the following data:

Port	External Cost	Hello Time	Edge	P2P	Forward BPDU	LBD	Port STP
1	AUTO/200000	2/2	No/No	Auto/Yes	Disabled	Disabled	Enabled
2	AUTO/200000	2/2	No/No	Auto/Yes	Disabled	Disabled	Enabled
3	AUTO/200000	2/2	No/No	Auto/Yes	Disabled	Disabled	Enabled
4	AUTO/200000	2/2	No/No	Auto/Yes	Disabled	Disabled	Enabled
5	AUTO/200000	2/2	No/No	Auto/Yes	Disabled	Disabled	Enabled
6	AUTO/200000	2/2	No/No	Auto/Yes	Disabled	Disabled	Enabled
7	AUTO/200000	2/2	No/No	Auto/Yes	Disabled	Disabled	Enabled
8	AUTO/200000	2/2	No/No	Auto/Yes	Disabled	Disabled	Enabled
9	AUTO/200000	2/2	No/No	Auto/Yes	Disabled	Disabled	Enabled
10	AUTO/200000	2/2	No/No	Auto/Yes	Disabled	Disabled	Enabled
11	AUTO/200000	2/2	No/No	Auto/Yes	Disabled	Disabled	Enabled
12	AUTO/200000	2/2	No/No	Auto/Yes	Disabled	Disabled	Enabled
13	AUTO/200000	2/2	No/No	Auto/Yes	Disabled	Disabled	Enabled
14	AUTO/200000	2/2	No/No	Auto/Yes	Disabled	Disabled	Enabled
15	AUTO/200000	2/2	No/No	Auto/Yes	Disabled	Disabled	Enabled
16	AUTO/200000	2/2	No/No	Auto/Yes	Disabled	Disabled	Enabled
17	AUTO/200000	2/2	No/No	Auto/Yes	Disabled	Disabled	Enabled
18	AUTO/200000	2/2	No/No	Auto/Yes	Disabled	Disabled	Enabled
19	AUTO/200000	2/2	No/No	Auto/Yes	Disabled	Disabled	Enabled
20	AUTO/200000	2/2	No/No	Auto/Yes	Disabled	Disabled	Enabled
21	AUTO/200000	2/2	No/No	Auto/Yes	Disabled	Disabled	Enabled
22	AUTO/200000	2/2	No/No	Auto/Yes	Disabled	Disabled	Enabled
23	AUTO/200000	2/2	No/No	Auto/Yes	Disabled	Disabled	Enabled
24	AUTO/200000	2/2	No/No	Auto/Yes	Disabled	Disabled	Enabled
25	AUTO/200000	2/2	No/No	Auto/Yes	Disabled	Disabled	Enabled
26	AUTO/200000	2/2	No/No	Auto/Yes	Disabled	Disabled	Enabled
27	AUTO/200000	2/2	No/No	Auto/Yes	Disabled	Disabled	Enabled
28	AUTO/200000	2/2	No/No	Auto/Yes	Disabled	Disabled	Enabled

Figure 7- 36. STP Port Settings window

The following STP Port Settings fields can be set:

Parameter	Description
From/To	A consecutive group of ports may be configured starting with the selected port.
External Cost	This defines a metric that indicates the relative cost of forwarding packets to the specified port list. Port cost can be set automatically or as a metric value. The default value is 0 (auto).

	<p>0 (<i>auto</i>) - Setting 0 for the external cost will automatically set the speed for forwarding packets to the specified port(s) in the list for optimal efficiency. Default port cost: 100Mbps port = 200000. Gigabit port = 20000.</p> <p>value 1-200000000 - Define a value between 1 and 200000000 to determine the external cost. The lower the number, the greater the probability the port will be chosen to forward packets.</p>
Hello Time	The time interval between transmissions of configuration messages by the designated port, to other devices on the bridged LAN. The user may choose a time between 1 and 10 seconds. The default is 2 seconds. This field is only operable when the Switch is enabled for MSTP.
Migration	When operating in RSTP mode, selecting yes forces the port that has been selected to transmit RSTP BPDUs.
Edge	Choosing the <i>True</i> parameter designates the port as an edge port. Edge ports cannot create loops, however an edge port can lose edge port status if a topology change creates a potential for a loop. An edge port normally should not receive BPDUs. If a BPDUs packet is received, it automatically loses edge port status. Choosing the <i>False</i> parameter indicates that the port does not have edge port status.
P2P	Choosing the <i>True</i> parameter indicates a point-to-point (P2P) shared link. P2P ports are similar to edge ports, however they are restricted in that a P2P port must operate in full duplex. Like edge ports, P2P ports transition to a forwarding state rapidly thus benefiting from RSTP. A p2p value of <i>False</i> indicates that the port cannot have p2p status. <i>Auto</i> allows the port to have p2p status whenever possible and operate as if the p2p status were true. If the port cannot maintain this status, (for example if the port is forced to half-duplex operation) the p2p status changes to operate as if the p2p value were <i>false</i> . The default setting for this parameter is <i>true</i> .
Forward BPDUs	Choosing <i>True</i> will allow the forwarding of BPDUs packets in the specified ports from other network devices. This will go into effect only if STP is globally disabled AND Forwarding BPDUs is globally enabled (See STP Bridge Global Settings above). The default setting <i>False</i> , does not forward BPDUs packets when STP is disabled.
LBD	Use the pull-down menu to enable or disable the Loopback Detection function on the Switch for the ports configured above. For more information on this function, see the Loopback Detection field in the STP Bridge Global Settings window, mentioned earlier in this section.
State	This drop-down menu allows you to enable or disable STP for the selected group of ports. The default is <i>Enabled</i> .

Click **Apply** to implement changes made.



NOTE: If you want to enable Forwarding BPDUs on a per port basis, the following settings must first be in effect: 1. STP must be globally disabled and 2. Forwarding BPDUs must be globally enabled. These are the default settings configurable in the **STP Bridge Global Settings** menu discussed previously.

STP Port Information of Instance

Information about a previously created STP Port instance can be viewed in the STP Port Instance Information window. To view the STP Port Instance Information window click **L2 Features > Spanning Tree > STP Port Information of Instance**. All information in this window is read-only and are described previously in this section. Each port has information regarding the individual port spanning tree settings.

STP Ports Instance Information 0										
Port	Designated Bridge	Internal PathCost	External Cost	Pri	Edge	P2P	LBD	Hello Time	Status	Role
1	N/A	200000	AUTO/200000	128	No/No	Auto/Yes	no	2/2	Forwarding	NonStp
2	N/A	200000	AUTO/200000	128	No/No	Auto/Yes	no	2/2	Disabled	Disabled
3	N/A	200000	AUTO/200000	128	No/No	Auto/Yes	no	2/2	Disabled	Disabled
4	N/A	200000	AUTO/200000	128	No/No	Auto/Yes	no	2/2	Disabled	Disabled
5	N/A	200000	AUTO/200000	128	No/No	Auto/Yes	no	2/2	Disabled	Disabled
6	N/A	200000	AUTO/200000	128	No/No	Auto/Yes	no	2/2	Disabled	Disabled
7	N/A	200000	AUTO/200000	128	No/No	Auto/Yes	no	2/2	Disabled	Disabled
8	N/A	200000	AUTO/200000	128	No/No	Auto/Yes	no	2/2	Disabled	Disabled
9	N/A	200000	AUTO/200000	128	No/No	Auto/Yes	no	2/2	Disabled	Disabled
10	N/A	200000	AUTO/200000	128	No/No	Auto/Yes	no	2/2	Disabled	Disabled
11	N/A	200000	AUTO/200000	128	No/No	Auto/Yes	no	2/2	Disabled	Disabled
12	N/A	200000	AUTO/200000	128	No/No	Auto/Yes	no	2/2	Disabled	Disabled
13	N/A	200000	AUTO/200000	128	No/No	Auto/Yes	no	2/2	Disabled	Disabled
14	N/A	200000	AUTO/200000	128	No/No	Auto/Yes	no	2/2	Disabled	Disabled
15	N/A	200000	AUTO/200000	128	No/No	Auto/Yes	no	2/2	Disabled	Disabled
16	N/A	200000	AUTO/200000	128	No/No	Auto/Yes	no	2/2	Disabled	Disabled
17	N/A	200000	AUTO/200000	128	No/No	Auto/Yes	no	2/2	Disabled	Disabled
18	N/A	200000	AUTO/200000	128	No/No	Auto/Yes	no	2/2	Disabled	Disabled
19	N/A	200000	AUTO/200000	128	No/No	Auto/Yes	no	2/2	Disabled	Disabled
20	N/A	200000	AUTO/200000	128	No/No	Auto/Yes	no	2/2	Disabled	Disabled
21	N/A	200000	AUTO/200000	128	No/No	Auto/Yes	no	2/2	Disabled	Disabled
22	N/A	200000	AUTO/200000	128	No/No	Auto/Yes	no	2/2	Disabled	Disabled
23	N/A	200000	AUTO/200000	128	No/No	Auto/Yes	no	2/2	Disabled	Disabled
24	N/A	200000	AUTO/200000	128	No/No	Auto/Yes	no	2/2	Disabled	Disabled
25	N/A	200000	AUTO/200000	128	No/No	Auto/Yes	no	2/2	Disabled	Disabled
26	N/A	200000	AUTO/200000	128	No/No	Auto/Yes	no	2/2	Disabled	Disabled
27	N/A	200000	AUTO/200000	128	No/No	Auto/Yes	no	2/2	Disabled	Disabled
28	N/A	200000	AUTO/200000	128	No/No	Auto/Yes	no	2/2	Disabled	Disabled

Figure 7- 37. STP Ports Instance Information window

Forwarding

Unicast Forwarding

The following figure and table describe how to set up **Multicast Forwarding** on the Switch. Open the **Forwarding** folder in the **L2 Features** menu and click on the **Unicast Forwarding** link.

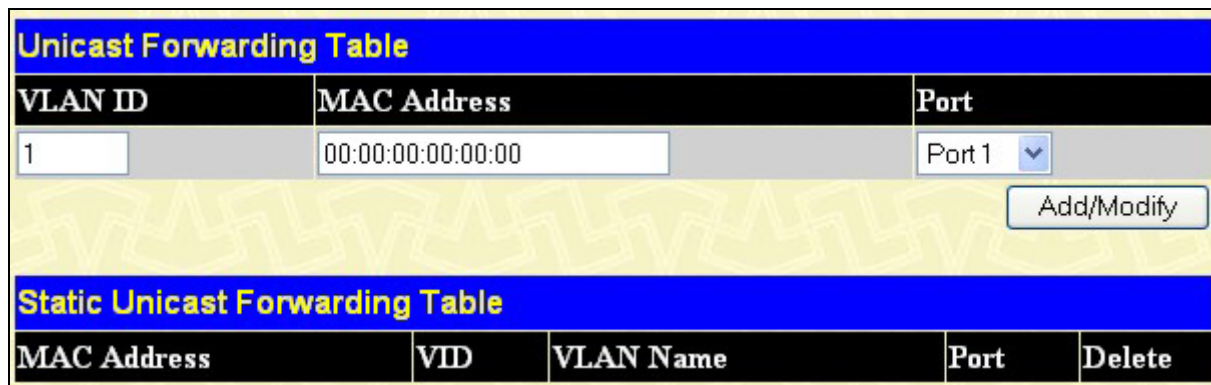



Figure 7- 38. Unicast Forwarding Table window

To add or edit an entry, define the following parameters and then click **Add/Modify**:

Parameter	Description
VLAN ID (VID)	The VLAN ID number of the VLAN on which the above Unicast MAC address resides.
MAC Address	The MAC address to which packets will be statically forwarded. This must be a unicast MAC address.
Port	Allows the selection of the port number on which the MAC address entered above resides.

To delete an entry in the **Unicast Forwarding Table**, click the corresponding  under the Delete heading.

Multicast Forwarding

The following figure and table describe how to set up **Multicast Forwarding** on the Switch. Open the **Forwarding** folder located in **L2 Features**, and click on the **Multicast Forwarding** link to see the entry screen below:

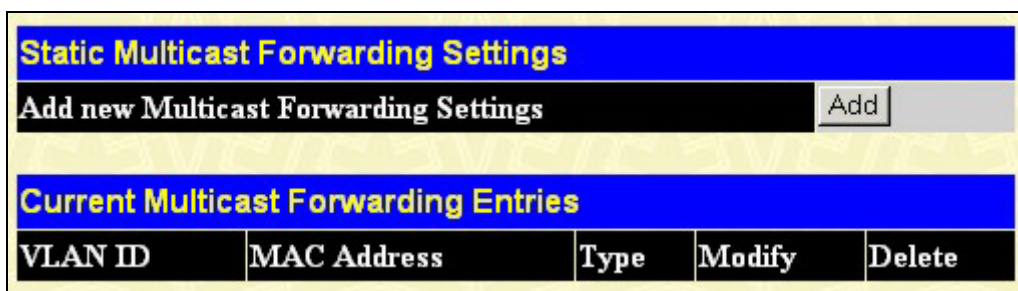

Figure 7- 39. Static Multicast Forwarding Settings window

The **Static Multicast Forwarding Settings** window displays all of the entries made into the Switch's static multicast forwarding table. Click the **Add** button to open the **Setup Static Multicast Forwarding Table** window, as shown below:

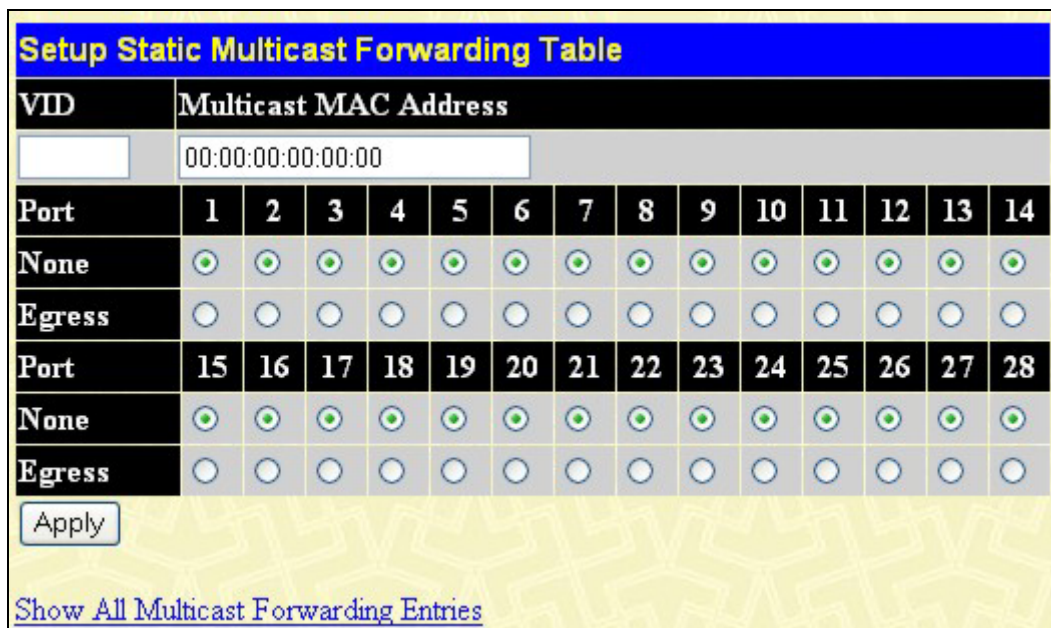



Figure 7- 40. Setup Static Multicast Forwarding Table window

The following parameters can be set:

Parameter	Description
VID	The VLAN ID of the VLAN to which the corresponding MAC address belongs.
Multicast MAC Address	The MAC address of the static source of multicast packets. This must be a multicast MAC address.
Port Settings	<p>Allows the selection of ports that will be members of the static multicast group and ports that are either forbidden from joining dynamically, or that can join the multicast group dynamically, using GMRP. The options are:</p> <p><i>None</i> - No restrictions on the port dynamically joining the multicast group. When None is chosen, the port will not be a member of the Static Multicast Group.</p> <p><i>Egress</i> - The port is a static member of the multicast group.</p>

Click **Apply** to implement the changes made. To delete an entry in the **Static Multicast Forwarding Table**, click the corresponding  under the Delete heading. Click the **Show All Multicast Forwarding Entries** link to return to the **Static Multicast Forwarding Settings** window.

Section 8

Layer 3 Features

IP Interface Settings

MD5 Key Settings

Route Redistribution Settings

Static/Dynamic Route Settings

Route Preference Settings

Static ARP Settings

RIP

OSPF

DCHP/BOOTP Relay

DNS Relay

VRRP

IP Multicast Routing Settings

The following section will aid the user in configuring security functions for the Switch. The Switch includes various functions for IP Interface Settings, MD5 Key Settings, Route Redistribution Settings, Static/Default Route Settings, Route Preference Settings, Static ARP Settings, RIP, OSPF, DCHP/BOOTP Relay, DNS Relay, VRRP, and IP Multicast Routing Protocol all discussed in detail in the following section.

IP Multinetting

IP Multinetting is a function that allows multiple IP interfaces to be assigned to the same VLAN. This is beneficial to the administrator when the number of IPs on the original interface is insufficient and the network administrator wishes not to resize the interface. IP Multinetting is capable of assigning another IP interface on the same VLAN without affecting the original stations or settings of the original interface.

Two types of interfaces are configured for IP multinetting, *primary* and *secondary*, and every IP interface must be classified as one of these. A *primary* interface refers to the first interface created on a VLAN, with no exceptions. All other interfaces created will be regarded as *secondary* only, and can only be created once a *primary* interface has been configured. There may be five interfaces per VLAN (one primary, and up to four secondary) and they are, in most cases, independent of each other. *Primary* interfaces cannot be deleted if the VLAN contains a *secondary* interface. Once the user creates multiple interfaces for a specified VLAN (*primary* and *secondary*), that set IP interface cannot be changed to another VLAN.



Application Limitation: A multicast router cannot be connected to IP interfaces that are utilizing the IP Multinetting function.



NOTE: Only the primary IP interface will support the BOOTP relay agent.

IP Multinetting is a valuable tool for network administrators requiring a multitude of IP addresses, but configuring the Switch for IP multinetting may cause troubleshooting and bandwidth problems, and should not be used as a long term solution. Problems may include:

- The Switch may use extra resources to process packets for multiple IP interfaces.
- The amount of broadcast data, such as RIP update packets and PIM hello packets, will be increased.

IP Interface Settings

Each VLAN must be configured prior to setting up the VLAN's corresponding IP interface.

An example is presented below:

VLAN Name	VID	Switch Ports
System (default)	1	5, 6, 7, 8, 21, 22, 23, 24
Engineer	2	9, 10, 11, 12
Marketing	3	13, 14, 15, 16
Finance	4	17, 18, 19, 20
Sales	5	1, 2, 3, 4
Backbone	6	25, 26

Table 8- 1. VLAN Example - Assigned Ports

In this case, six IP interfaces are required, so a CIDR notation of 10.32.0.0/11 (or a 11-bit) addressing scheme will work. This addressing scheme will give a subnet mask of 11111111.11100000.00000000.00000000 (binary) or 255.224.0.0 (decimal).

Using a 10.xxx.xxx.xxx IP address notation, the above example would give 6 network addresses and 6 subnets. Any IP address from the allowed range of IP addresses for each subnet can be chosen as an IP address for an IP interface on the switch. For this example, we have chosen the next IP address above the network address for the IP interface's IP Address:

VLAN Name	VID	Network Number	IP Address
System (default)	1	10.32.0.0	10.32.0.1
Engineer	2	10.64.0.0	10.64.0.1
Marketing	3	10.96.0.0	10.96.0.1
Finance	4	10.128.0.0	10.128.0.1
Sales	5	10.160.0.0	10.160.0.1
Backbone	6	10.192.0.0	10.192.0.1

Table 8- 2. VLAN Example - Assigned IP Interfaces

The six IP interfaces, each with an IP address (listed in the table above), and a subnet mask of 255.224.0.0 can be entered into the **IP Interface Settings** window.

To setup IP Interfaces on the Switch:

Go to the **L3 Features** folder, and click on the folder, and then click on the **IP Interfaces Settings** link to open the following dialog box:

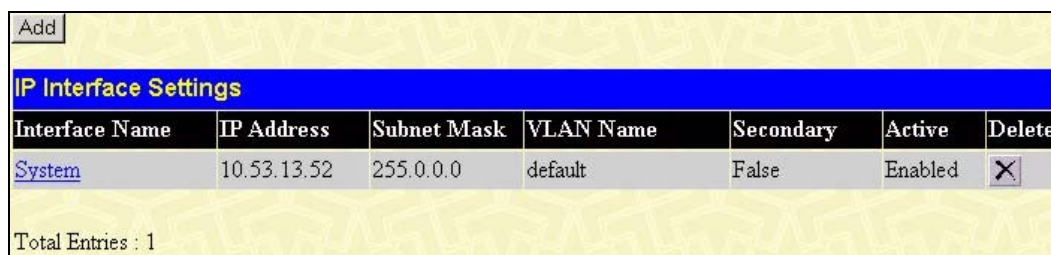

Figure 8- 1. IP Interface Table window

To setup a new IP interface, click the **Add** button. To edit an existing IP Interface entry, click on an entry under the **Interface Name** heading. Both actions will result in the same screen to configure, as shown below.

Figure 8- 2. IP Interface Settings – Add

Figure 8- 3. IP Interface Settings - Edit

Enter a name for the new interface to be added in the **Interface Name** field (if you are editing an IP interface, the **Interface Name** will already be in the top field as seen in the window above). Enter the interface’s IP address and subnet mask in the corresponding fields. Pull the **State** pull-down menu to *Enabled* and click **Apply** to enter to make the IP interface effective. To view entries in the **IP Interface Table**, click the [Show All IP Interface Entries](#) hyperlink. Use the **Save Changes** dialog box to enter the changes into NV-RAM.

The following fields can be set:

Parameter	Description
Interface Name	This field displays the name for the IP interface. The default IP interface is named “System”.
IP Address	This field allows the entry of an IP address to be assigned to this IP interface.
Subnet Mask	This field allows the entry of a subnet mask to be applied to this IP interface.
VLAN Name	This field allows the entry of the VLAN Name for the VLAN the IP interface belongs to.
Secondary	Use the pull-down menu to set the IP interface as <i>True</i> or <i>False</i> . <i>True</i> will set the interface as secondary and <i>False</i> will denote the interface as the primary interface of the VLAN entered above. <i>Secondary</i> interfaces can only be configured if a <i>primary</i> interface is first configured.
State	This field may be altered between <i>Enabled</i> and <i>Disabled</i> using the pull down menu. This entry determines whether the interface will be active or not.
Link Status	This read only field states the current status of the IP Interface on the Switch. <i>Link Up</i> denotes that the IP interface is up and running on the Switch. <i>Link Down</i> will denote that the IP interface is not currently set and/or enabled on the Switch.

Click **Apply** to implement changes made.

MD5 Key Settings

The **MD5 Key Settings** menu allows the entry of a 16 character Message Digest – version 5 (MD5) key which can be used to authenticate every packet exchanged between OSPF routers. It is used as a security mechanism to limit the exchange of network topology information to the OSPF routing domain. MD5 Keys created here can be used in the **OSPF** menu below.

To configure an **MD5 Key**, click **Layer 3 Features > MD5 Key Settings** to open the following window:

MD5 Key Settings	
Key ID (1-255)	Key
1	
Add/Modify	

MD5 Key Table		
Key ID	Key	Delete
1	45	✕

Figure 8- 4. MD5 Key Settings and Table window

The following fields can be set:

Parameter	Description
Key ID (1-255)	A number from 1 to 255 used to identify the MD5 Key.
Key	A alphanumeric string of between 1 and 16 case-sensitive characters used to generate the Message Digest which is in turn, used to authenticate OSPF packets within the OSPF routing domain.

Click **Apply** to enter the new Key ID settings. To delete a Key ID entry, click the corresponding ✕ under the *Delete* heading.

Route Redistribution Settings

Route redistribution allows routers on the network, which are running different routing protocols to exchange routing information. This is accomplished by comparing the routes stored in the various routers routing tables and assigning appropriate metrics. This information is then exchanged among the various routers according to the individual routers current routing protocol. The Switch can redistribute routing information between the OSPF and RIP routing protocols to all routers on the network that are running OSPF or RIP. Routing information entered into the **Static Routing Table** on the local xStack switch is also redistributed.

Routing information source – OSPF and the Static Route table. Routing information will be redistributed to RIP. The following table lists the allowed values for the routing metrics and the types (or forms) of the routing information that will be redistributed.

Route Source	Metric	Type
OSPF	0 to 16	All Internal External ExtType1 ExtType2 Inter-E1 Inter-E2
RIP	0 to 16777214	Type 1 Type 2
Static	0 to 16777214	Type 1 Type 2
Local	0 to 16777214	Type 1 Type 2

Table 8- 3. Route Redistribution Source table

Entering the Type combination – internal type_1 type_2 is functionally equivalent to all. Entering the combination type_1 type_2 is functionally equivalent to external. Entering the combination internal external is functionally equivalent to all.

Entering the metric 0 specifies transparency.

This window will redistribute routing information between the OSPF and RIP routing protocols to all routers on the network that are running OSPF or RIP. To access the **Route Redistribution Settings** window, go to > **L3 Features** > **Route Redistribution Settings**:

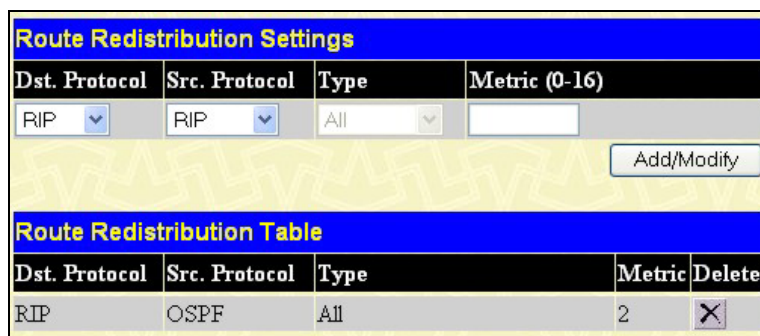

Figure 8- 5. Route Redistribution Settings and Table window

The following parameters may be set or viewed:

Parameter	Description
Dst. Protocol	Allows for the selection of the protocol for the destination device. Choose between <i>RIP</i> and <i>OSPF</i> .
Src. Protocol	Allows for the selection of the protocol for the source device. Choose between <i>RIP</i> , <i>OSPF</i> , <i>Static</i> and <i>Local</i> .
Type	Allows for the selection of one of six methods of calculating the metric value. The user may choose between <i>All</i> , <i>Internal</i> , <i>External</i> , <i>ExtType1</i> , <i>ExtType2</i> , <i>Inter-E1</i> , <i>Inter-E2</i> . See the table above for available metric value types for each source protocol.
Metric	Allows the entry of an OSPF interface cost. This is analogous to a Hop Count in the RIP routing protocol. The user may specify a cost between 0 and 16.

Click **Add/Modify** to implement changes made.



NOTE: The source protocol (**Src. Protocol**) entry and the destination protocol (**Dst. Protocol**) entry cannot be the same.

Static/Default Route Settings

Entries into the Switch’s forwarding table can be made using both MAC addresses and IP addresses. Static IP forwarding is accomplished by the entry of an IP address into the Switch’s **Static IP Routing Table**. To view the following window, click **L3 Features > Static/Default Route Settings**.

Static/Default Route Settings						
IP Address	Subnet Mask	Gateway	Metric	Protocol	Backup State	Delete
11.0.0.0	255.0.0.0	10.1.1.254	1	Static	Primary	<input type="checkbox"/>

Total Entries : 1

Figure 8- 6. Static/Default Route Settings window

This window shows the following values:

Parameter	Description
IP Address	The IP address of the Static/Default Route.
Subnet Mask	The corresponding Subnet Mask of the IP address entered into the table.
Gateway	The corresponding Gateway of the IP address entered into the table.
Metric	Represents the metric value of the IP interface entered into the table. This field may read a number between 1-65535 for an OSPF setting, and 1-16 for a RIP setting.
Protocol	Represents the protocol used for the Routing Table entry of the IP interface. This field may read OSPF, RIP, Static or Local.
Backup State	Represents the Backup state that this IP interface is configured for. This field may read Primary or Backup.
Delete	Click the <input type="checkbox"/> if you would like to delete this entry from the Static/Default Route Settings table.

To enter an IP Interface into the Switch’s **Static/Default Route Settings** window, click the **Add** button, revealing the following window to configure.

Static/Default Route Settings - Add	
IP Address	<input type="text" value="0.0.0.0"/>
Subnet Mask	<input type="text" value="0.0.0.0"/>
Gateway	<input type="text" value="0.0.0.0"/>
Metric (1-65535)	<input type="text" value="1"/>
Backup State	Primary <input type="button" value="v"/>

[Show All Static/Default Route Entries](#)

Figure 8- 7. Static/Default Route Settings – Add window

The following fields can be set:

Parameter	Description
IP Address	Allows the entry of an IP address that will be a static entry into the Switch's Routing Table.
Subnet Mask	Allows the entry of a subnet mask corresponding to the IP address above.
Gateway IP	Allows the entry of an IP address of a gateway for the IP address above.
Metric (1-65535)	Allows the entry of a routing protocol metric representing the number of routers between the Switch and the IP address above.
Backup State	The user may choose between <i>Primary</i> and <i>Backup</i> . If the Primary Static/Default Route fails, the Backup Route will support the entry. Please take note that the Primary and Backup entries cannot have the same Gateway.

Click **Apply** to implement changes made.

Route Preference Settings

Route Preference is a way for routers to select the best path when there are two or more different routes to the same destination from two different routing protocols. The majority of routing protocols are not compatible when used in conjunction with each other. This Switch supports and may be configured for many routing protocols, as a stand-alone switch or more importantly, in utilizing the stacking function and Single IP Management of the Switch. Therefore, the ability to exchange route information and select the best path is essential to optimal use of the Switch and its capabilities.

The first decision the Switch will make in selecting the best path is to consult the Route Preference Settings table of the switch. This table can be viewed by clicking **Configuration > L3 IP Networking > Route Preference Settings**, and it holds the list of possible routing protocols currently implemented on the Switch, along with a **Preference** value which determines which routing protocol will be the most dependable to route packets. Below is a list of the default route preferences set on the Switch.

Route Type	Validity Range	Default Value
Local	0 - Permanently set on the Switch and not configurable.	0
Static	1 - 999	60
OSPF Intra	1 - 999	80
OSPF Inter	1 - 999	90
RIP	1 - 999	100
OSPF ExtT1	1 - 999	110
OSPF ExtT2	1 - 999	115

As shown above, *Local* will always be the first choice for routing purposes and the next most reliable path is *Static* due to the fact that its has the next lowest value. To set a higher reliability for a route, change its value to a number less than the value of a route preference that has a greater reliability value using the **New Route Preference Settings** window command. For example, if the user wishes to make RIP the most reliable route, the user can change its value to one that is less than the lowest value (Static - 60) or the user could change the other route values to more than 100.

The user should be aware of three points before configuring the route preference:

1. No two route preference values can be the same. Entering the same route preference may cause the Switch to crash due to indecision by the Switch.
2. If the user is not fully aware of all the features and functions of the routing protocols on the Switch, a change in the default route preference value may cause routing loops or black holes.

3. After changing the route preference value for a specific routing protocol, that protocol needs to be restarted because the previously learned routes have been dropped from the switch. The Switch must learn the routes again before the new settings can take affect.

To view the **Route Preference Settings** window, click **L3 Features > Route Preference Settings**:

Route Preference Settings	
Route Type	Preference
RIP	100
OSPF Intra	80
STATIC	60
LOCAL	0
OSPF Inter	90
OSPF ExtT1	110
OSPF ExtT2	115

New Route Preference Settings	
Route Type	Preference
RIP(1-999)	<input type="text" value="100"/>
OSPF Intra(1-999)	<input type="text" value="80"/>
STATIC(1-999)	<input type="text" value="60"/>
OSPF Inter(1-999)	<input type="text" value="90"/>
OSPF ExtT1(1-999)	<input type="text" value="110"/>
OSPF ExtT2(1-999)	<input type="text" value="115"/>

Figure 8- 8. Route Preference Settings window

The following fields can be viewed or set:

Parameter	Description
RIP (1-999)	Enter a value between 1 and 999 to set the route preference for <i>RIP</i> . The lower the value, the higher the chance the specified protocol will be chosen as the best path for routing packets. The default value is 100.
OSPF Intra (1-999)	Enter a value between 1 and 999 to set the route preference for <i>OSPF Intra</i> . The lower the value, the higher the chance the specified protocol will be chosen as the best path for routing packets. The default value is 80.
STATIC (1-999)	Enter a value between 1 and 999 to set the route preference for <i>Static</i> . The lower the value, the higher the chance the specified protocol will be chosen as the best path for routing packets. The default value is 60.
OSPF Inter (1-999)	Enter a value between 1 and 999 to set the route preference for <i>OSPF Inter</i> . The lower the value, the higher the chance the specified protocol will be chosen as the best path for routing packets. The default value is 90.
OSPF ExtT1 (1-999)	Enter a value between 1 and 999 to set the route preference for <i>OSPF ExtT1</i> . The lower the value, the higher the chance the specified protocol will be chosen as the best path for routing packets. The default value is 110.
OSPF ExtT2 (1-999)	Enter a value between 1 and 999 to set the route preference for <i>OSPF ExtT2</i> . The lower the value, the higher the chance the specified protocol will be chosen as the best path for routing packets. The default value is 115.

Click **Apply** to implement changes made.

Static ARP Table

The Address Resolution Protocol (ARP) is a TCP/IP protocol that converts IP addresses into physical addresses. This table allows network managers to view, define, modify and delete ARP information for specific devices. Static entries can be defined in the ARP Table. When static entries are defined, a permanent entry is entered and is used to translate IP address to MAC addresses.

To open the **Static ARP Table** open the **L3 Features** folder and click on the **Static ARP Settings** link.

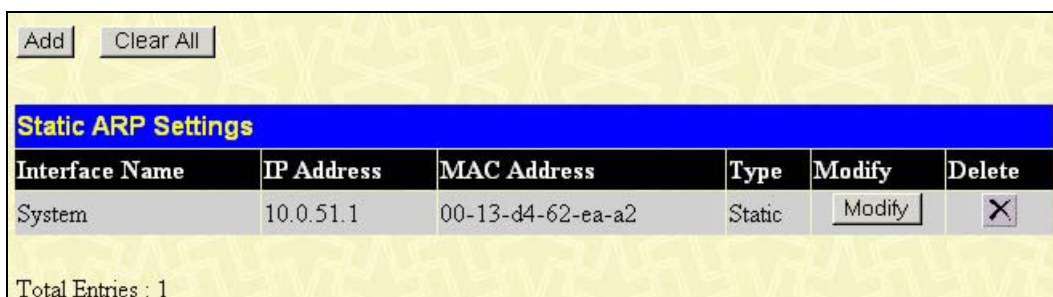

Figure 8- 9. Static ARP Settings window

To add a new entry, click the **Add** button, revealing the following window to configure:

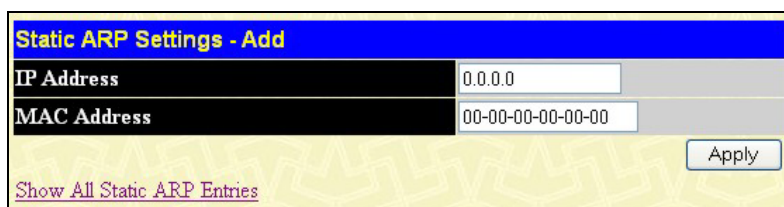

Figure 8- 10. Static ARP Table – Add window

The following fields can be set:

Parameter	Description
IP Address	The IP address of the ARP entry.
MAC Address	The MAC address of the ARP entry.

After entering the IP Address and MAC Address of the Static ARP entry, click **Apply** to implement the new entry. To completely clear the Static ARP Settings, click the **Clear All** button.



NOTE: The Switch supports up to 255 static ARP entries.

RIP

The Routing Information Protocol is a distance-vector routing protocol. There are two types of network devices running RIP - active and passive. Active devices advertise their routes to others through RIP messages, while passive devices listen to these messages. Both active and passive routers update their routing tables based upon RIP messages that active routers exchange. Only routers can run RIP in the active mode.

Every 30 seconds, a router running RIP broadcasts a routing update containing a set of pairs of network addresses and a distance (represented by the number of hops or routers between the advertising router and the remote network). So, the vector is the network address and the distance is measured by the number of routers between the local router and the remote network.

RIP measures distance by an integer count of the number of hops from one network to another. A router is one hop from a directly connected network, two hops from a network that can be reached through a router, etc. The more routers between a source and a destination, the greater the RIP distance (or hop count).

There are a few rules to the routing table update process that help to improve performance and stability. A router will not replace a route with a newly learned one if the new route has the same hop count (sometimes referred to as 'cost'). So learned routes are retained until a new route with a lower hop count is learned.

When learned routes are entered into the routing table, a timer is started. This timer is restarted every time this route is advertised. If the route is not advertised for a period of time (usually 180 seconds), the route is removed from the routing table.

RIP does not have an explicit method to detect routing loops. Many RIP implementations include an authorization mechanism (a password) to prevent a router from learning erroneous routes from unauthorized routers.

To maximize stability, the hop count RIP uses to measure distance must have a low maximum value. Infinity (that is, the network is unreachable) is defined as 16 hops. In other words, if a network is more than 16 routers from the source, the local router will consider the network unreachable.

RIP can also be slow to converge (to remove inconsistent, unreachable or looped routes from the routing table) because RIP messages propagate relatively slowly through a network.

Slow convergence can be solved by using split horizon update, where a router does not propagate information about a route back to the interface on which it was received. This reduces the probability of forming transient routing loops.

Hold down can be used to force a router to ignore new route updates for a period of time (usually 60 seconds) after a new route update has been received. This allows all routers on the network to receive the message.

A router can 'poison reverse' a route by adding an infinite (16) hop count to a route's advertisement. This is usually used in conjunction with triggered updates, which force a router to send an immediate broadcast when an update of an unreachable network is received.

RIP Version 1 Message Format

There are two types of RIP messages: routing information messages and information requests. Both types use the same format.

The Command field specifies an operation according the following table:

Command	Meaning
1	Request for partial or full routing information
2	Response containing network-distance pairs from sender's routing table
3	Turn on trace mode (obsolete)
4	Turn off trace mode (obsolete)
5	Reserved for Sun Microsystem's internal use
9	Update Request
10	Update Response
11	Update Acknowledgement

RIP Command Codes

The field VERSION contains the protocol version number (1 in this case), and is used by the receiver to verify which version of RIP the packet was sent.

RIP 1 Message

RIP is not limited to TCP/IP. Its address format can support up to 14 octets (when using IP, the remaining 10 octets must be zeros). Other network protocol suites can be specified in the Family of Source Network field (IP has a value of 2). This will determine how the address field is interpreted.

RIP specifies that the IP address, 0.0.0.0, denotes a default route.

The distances, measured in router hops are entered in the Distance to Source Network, and Distance to Destination Network fields.

RIP 1 Route Interpretation

RIP was designed to be used with classed address schemes, and does not include an explicit subnet mask. An extension to version 1 does allow routers to exchange subnetted addresses, but only if the subnet mask used by the network is the same as the subnet mask used by the address. This means the RIP version 1 cannot be used to propagate classless addresses.

Routers running RIP version 1 must send different update messages for each IP interface to which it is connected. Interfaces that use the same subnet mask as the router's network can contain subnetted routes, other interfaces cannot. The router will then advertise only a single route to the network.

RIP Version 2 Extensions

RIP version 2 includes an explicit subnet mask entry, so RIP version 2 can be used to propagate variable length subnet addresses or CIDR classless addresses. RIP version 2 also adds an explicit next hop entry, which speeds convergence and helps prevent the formation of routing loops.

RIP2 Message Format

The message format used with RIP2 is an extension of the RIP1 format:

RIP version 2 also adds a 16-bit route tag that is retained and sent with router updates. It can be used to identify the origin of the route.

Because the version number in RIP2 occupies the same octet as in RIP1, both versions of the protocols can be used on a given router simultaneously without interference.

RIP Global Settings

To setup RIP for the IP interfaces configured on the Switch, the user must first globally enable RIP and then configure RIP settings for the individual IP interfaces. To globally enable RIP on the Switch, open the **L3 Features** and then open the **RIP** folder and click on the **RIP Global Settings** link to access the following screen:

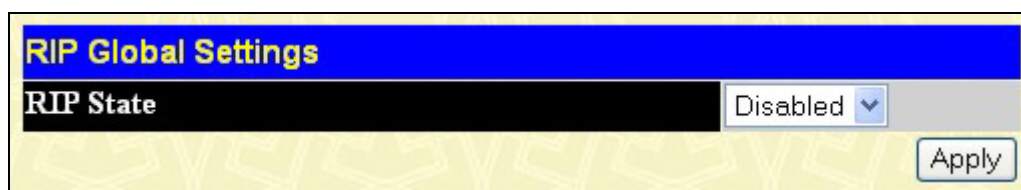

Figure 8- 11. RIP Global Settings window

To enable RIP, simply use the pull-down menu, select **Enabled** and click **Apply**.

RX Mode	Toggle among <i>Disabled</i> , <i>V1 Only</i> , <i>V2 Only</i> , and <i>V1 or V2</i> . This entry specifies which version of the RIP protocol will be used to interpret received RIP packets. <i>Disabled</i> prevents the reception of RIP packets.
Authentication	Toggle between <i>Disabled</i> and <i>Enabled</i> to specify that routers on the network should use the Password above to authenticate router table exchanges.
Password	A password to be used to authenticate communication between routers on the network.
State	Toggle between <i>Disabled</i> and <i>Enabled</i> to disable or enable this RIP interface on the switch.
Interface Metric	A read only field that denotes the Metric value of the current IP Interface setting.

Click **Apply** to implement changes made.

OSPF

The Open Shortest Path First (OSPF) routing protocol uses a *link-state* algorithm to determine routes to network destinations. A “link” is an interface on a router and the “state” is a description of that interface and its relationship to neighboring routers. The state contains information such as the IP address, subnet mask, type of network the interface is attached to, other routers attached to the network, etc. The collection of link-states is then collected in a link-state database that is maintained by routers running OSPF.

OSPF specifies how routers will communicate to maintain their link-state database and defines several concepts about the topology of networks that use OSPF.

To limit the extent of link-state update traffic between routers, OSPF defines the concept of *Area*. All routers within an area share the exact same link-state database, and a change to this database on one router triggers an update to the link-state database of all other routers in that area. Routers that have interfaces connected to more than one area are called *Border Routers* and take the responsibility of distributing routing information between areas.

One area is defined as *Area 0* or the *Backbone*. This area is central to the rest of the network in that all other areas have a connection (through a router) to the backbone. Only routers have connections to the backbone and OSPF is structured such that routing information changes in other areas will be introduced into the backbone, and then propagated to the rest of the network.

When constructing a network to use OSPF, it is generally advisable to begin with the backbone (area 0) and work outward

Link-State Algorithm

An OSPF router uses a link-state algorithm to build a shortest path tree to all destinations known to the router. The following is a simplified description of the algorithm’s steps:

- When OSPF is started, or when a change in the routing information changes, the router generates a link-state advertisement. This advertisement is a specially formatted packet that contains information about all the link-states on the router.
- This link-state advertisement is flooded to all routers in the area. Each router that receives the link-state advertisement will store the advertisement and then forward a copy to other routers.
- When the link-state database of each router is updated, the individual routers will calculate a Shortest Path Tree to all destinations – with the individual router as the root. The IP routing table will then be made up of the destination address, associated cost, and the address of the next hop to reach each destination.
- Once the link-state databases are updated, Shortest Path Trees calculated, and the IP routing tables written – if there are no subsequent changes in the OSPF network (such as a network link going down) there is very little OSPF traffic.

Shortest Path Algorithm

The Shortest Path to a destination is calculated using the Dijkstra algorithm. Each router is placed at the root of a tree and then calculates the shortest path to each destination based on the cumulative cost to reach that destination over multiple possible routes. Each router will then have its own Shortest Path Tree (from the perspective of its location in the network area) even though every router in the area will have and use the exact same link-state database.

The following sections describe the information used to build the Shortest Path Tree.

OSPF Cost

Each OSPF interface has an associated cost (also called “metric”) that is representative of the overhead required to send packets over that interface. This cost is inversely proportional to the bandwidth of the interface (i.e. a higher bandwidth interface has a lower cost). There is then a higher cost (and longer time delays) in sending packets over a 56 Kbps dial-up connection than over a 10 Mbps Ethernet connection. The formula used to calculate the OSPF cost is as follows:

$$\text{Cost} = 100,000,000 / \text{bandwidth in bps}$$

As an example, the cost of a 10 Mbps Ethernet line will be 10 and the cost to cross a 1.544 Mbps T1 line will be 64.

Shortest Path Tree

To build Router A’s shortest path tree for the network diagramed below, Router A is put at the root of the tree and the smallest cost link to each destination network is calculated.

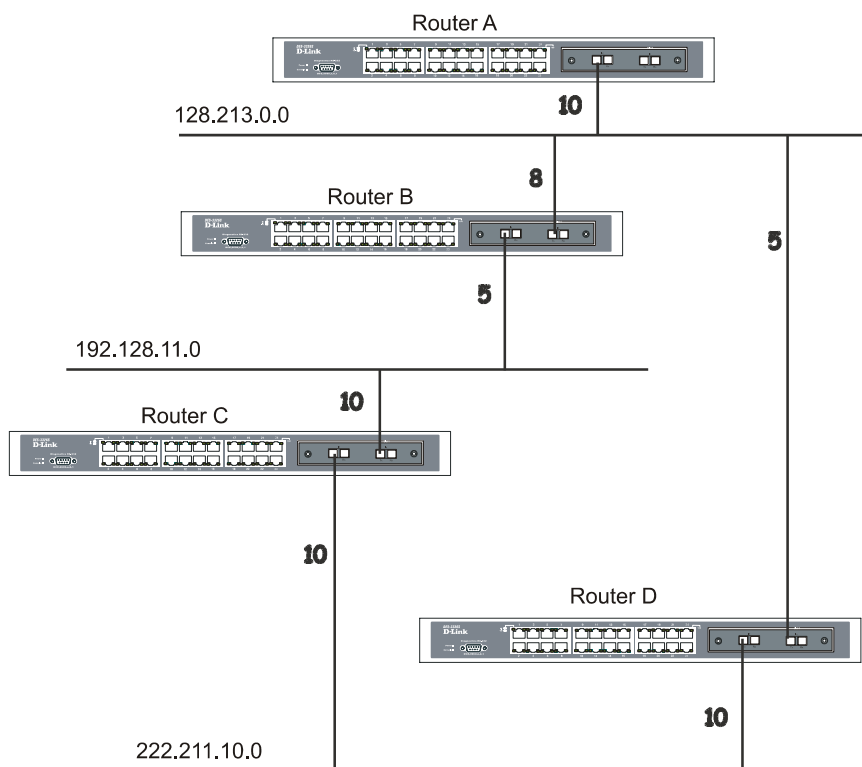

Figure 8- 14. Constructing a Shortest Path Tree

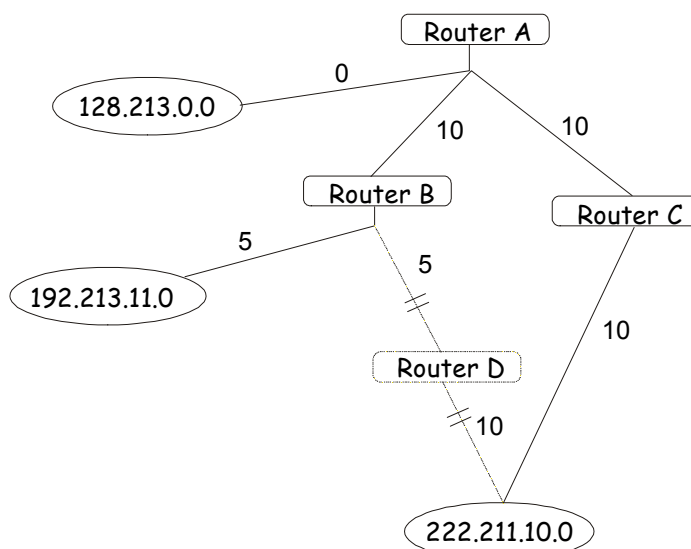

Figure 8- 15. Constructing a Shortest Path Tree

The diagram above shows the network from the viewpoint of Router A. Router A can reach 192.213.11.0 through Router B with a cost of 10 + 5 = 15. Router A can reach 222.211.10.0 through Router C with a cost of 10 + 10 = 20. Router A can also reach

222.211.10.0 through Router B and Router D with a cost of $10 + 5 + 10 = 25$, but the cost is higher than the route through Router C. This higher-cost route will not be included in the Router A's shortest path tree. The resulting tree will look like this:

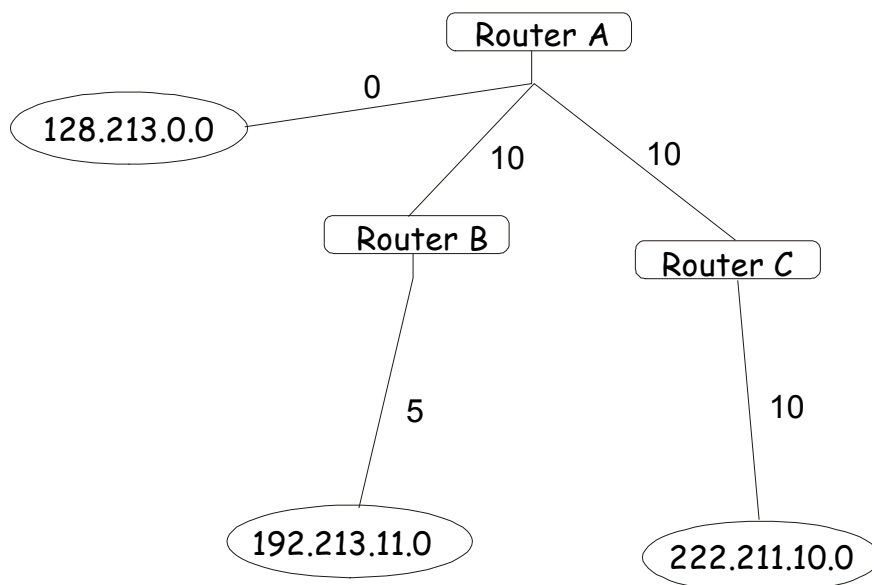

Figure 8- 16. Constructing a Shortest Path Tree - Completed

Note that this shortest path tree is only from the viewpoint of Router A. The cost of the link from Router B to Router A, for instance is not important to constructing Router A's shortest path tree, but is very important when Router B is constructing its shortest path tree.

Note also that directly connected networks are reached at a cost of zero, while other networks are reached at the cost calculated in the shortest path tree.

Router A can now build its routing table using the network addresses and costs calculated in building the above shortest path tree.

Areas and Border Routers

OSPF link-state updates are forwarded to other routers by flooding to all routers on the network. OSPF uses the concept of areas to define where on the network routers that need to receive particular link-state updates are located. This helps ensure that routing updates are not flooded throughout the entire network and to reduce the amount of bandwidth consumed by updating the various router's routing tables.

Areas establish boundaries beyond which link-state updates do not need to be flooded. So the exchange of link-state updates and the calculation of the shortest path tree are limited to the area that the router is connected to.

Routers that have connections to more than one area are called Border Routers (BR). The Border Routers have the responsibility of distributing necessary routing information and changes between areas.

Areas are specific to the router interface. A router that has all of its interfaces in the same area is called an Internal Router. A router that has interfaces in multiple areas is called a Border Router. Routers that act as gateways to other networks (possibly using other routing protocols) are called Autonomous System Border Routers (ASBRs).

Link-State Packets

There are a number of different types of link-state packets, four of which are illustrated below:

- Router Link-State Updates – These describe a router's links to destinations within an area.
- Summary Link-State Updates – Issued by Border Routers and describe links to networks outside the area but within the Autonomous System (AS).
- Network Link-State Updates – Issued by multi-access areas that have more than one attached router. One router is elected as the Designated Router (DR) and this router issues the network link-state updates describing every router on the segment.
- External Link-State Updates – Issued by an Autonomous System Border Router and describes routes to destinations outside the AS or a default route to the outside AS.

The format of these link-state updates is described in more detail below.

Router link-state updates are flooded to all routers in the current area. These updates describe the destinations reachable through all of the router's interfaces.

Summary link-state updates are generated by Border Routers to distribute routing information about other networks within the AS. Normally, all Summary link-state updates are forwarded to the backbone (area 0) and are then forwarded to all other areas in the network. Border Routers also have the responsibility of distributing routing information from the Autonomous System Border Router in order for routers in the network to get and maintain routes to other Autonomous Systems.

Network link-state updates are generated by a router elected as the Designated Router on a multi-access segment (with more than one attached router). These updates describe all of the routers on the segment and their network connections.

External link-state updates carry routing information to networks outside the Autonomous System. The Autonomous System Border Router is responsible for generating and distributing these updates.

OSPF Authentication

OSPF packets can be authenticated as coming from trusted routers by the use of predefined passwords. The default for routers is to use not authentication.

There are two other authentication methods – simple password authentication (key) and Message Digest authentication (MD-5).

Message Digest Authentication (MD-5)

MD-5 authentication is a cryptographic method. A key and a key-ID are configured on each router. The router then uses an algorithm to generate a mathematical “message digest” that is derived from the OSPF packet, the key and the key-ID. This message digest (a number) is then appended to the packet. The key is not exchanged over the wire and a non-decreasing sequence number is included to prevent replay attacks.

Simple Password Authentication

A password (or key) can be configured on a per-area basis. Routers in the same area that participate in the routing domain must be configured with the same key. This method is possibly vulnerable to passive attacks where a link analyzer is used to obtain the password.

Backbone and Area 0

OSPF limits the number of link-state updates required between routers by defining areas within which a given router operates. When more than one area is configured, one area is designated as area 0 – also called the backbone.

The backbone is at the center of all other areas – all areas of the network have a physical (or virtual) connection to the backbone through a router. OSPF allows routing information to be distributed by forwarding it into area 0, from which the information can be forwarded to all other areas (and all other routers) on the network.

In situations where an area is required, but is not possible to provide a physical connection to the backbone, a virtual link can be configured.

Virtual Links

Virtual links accomplish two purposes:

- Linking an area that does not have a physical connection to the backbone.
- Patching the backbone in case there is a discontinuity in area 0.

Areas Not Physically Connected to Area 0

All areas of an OSPF network should have a physical connection to the backbone, but in some cases it is not possible to physically connect a remote area to the backbone. In these cases, a virtual link is configured to connect the remote area to the backbone. A virtual path is a logical path between two border routers that have a common area, with one border router connected to the backbone.

Partitioning the Backbone

OSPF also allows virtual links to be configured to connect the parts of the backbone that are discontinuous. This is the equivalent to linking different area 0s together using a logical path between each area 0. Virtual links can also be added for redundancy to protect against a router failure. A virtual link is configured between two border routers that both have a connection to their respective area 0s.

Neighbors

Routers that are connected to the same area or segment become neighbors in that area. Neighbors are elected via the Hello protocol. IP multicast is used to send out Hello packets to other routers on the segment. Routers become neighbors when they see themselves listed in a Hello packet sent by another router on the same segment. In this way, two-way communication is guaranteed to be possible between any two neighbor routers.

Any two routers must meet the following conditions before they become neighbors:

- **Area ID** – Two routers having a common segment – their interfaces have to belong to the same area on that segment. Of course, the interfaces should belong to the same subnet and have the same subnet mask.
- **Authentication** – OSPF allows for the configuration of a password for a specific area. Two routers on the same segment and belonging to the same area must also have the same OSPF password before they can become neighbors.
- **Hello and Dead Intervals** – The Hello interval specifies the length of time, in seconds, between the hello packets that a router sends on an OSPF interface. The dead interval is the number of seconds that a router's Hello packets have not been seen before its neighbors declare the OSPF router down. OSPF routers exchange Hello packets on each segment in order to acknowledge each other's existence on a segment and to elect a Designated Router on multi-access segments. OSPF requires these intervals to be exactly the same between any two neighbors. If any of these intervals are different, these routers will not become neighbors on a particular segment.
- **Stub Area Flag** – Any two routers also have to have the same stub area flag in their Hello packets in order to become neighbors.

Adjacencies

Adjacent routers go beyond the simple Hello exchange and participate in the link-state database exchange process. OSPF elects one router as the Designated Router (DR) and a second router as the Backup Designated Router (BDR) on each multi-access segment (the BDR is a backup in case of a DR failure). All other routers on the segment will then contact the DR for link-state database updates and exchanges. This limits the bandwidth required for link-state database updates.

Designated Router Election

The election of the DR and BDR is accomplished using the Hello protocol. The router with the highest OSPF priority on a given multi-access segment will become the DR for that segment. In case of a tie, the router with the highest Router ID wins. The default OSPF priority is 1. A priority of zero indicates a router that cannot be elected as the DR.

Building Adjacency

Two routers undergo a multi-step process in building the adjacency relationship. The following is a simplified description of the steps required:

- **Down** – No information has been received from any router on the segment.
- **Attempt** – On non-broadcast multi-access networks (such as Frame Relay or X.25), this state indicates that no recent information has been received from the neighbor. An effort should be made to contact the neighbor by sending Hello packets at the reduced rate set by the Poll Interval.
- **Init** – The interface has detected a Hello packet coming from a neighbor but bi-directional communication has not yet been established.
- **Two-way** – Bi-directional communication with a neighbor has been established. The router has seen its address in the Hello packets coming from a neighbor. At the end of this stage the DR and BDR election would have been done. At the end of the Two-way stage, routers will decide whether to proceed in building an adjacency or not. The decision is based on whether one of the routers is a DR or a BDR or the link is a point-to-point or virtual link.
- **Exstart** – (Exchange Start) Routers establish the initial sequence number that is going to be used in the information exchange packets. The sequence number insures that routers always get the most recent information. One router will become the primary and the other will become secondary. The primary router will poll the secondary for information.
- **Exchange** – Routers will describe their entire link-state database by sending database description packets.
- **Loading** – The routers are finalizing the information exchange. Routers have link-state request list and a link-state retransmission list. Any information that looks incomplete or outdated will be put on the request list. Any update that is sent will be put on the retransmission list until it gets acknowledged.
- **Full** – The adjacency is now complete. The neighboring routers are fully adjacent. Adjacent routers will have the same link-state database.

Adjacencies on Point-to-Point Interfaces

OSPF Routers that are linked using point-to-point interfaces (such as serial links) will always form adjacencies. The concepts of DR and BDR are unnecessary.

OSPF Packet Formats

All OSPF packet types begin with a standard 24-byte header and there are five packet types. The header is described first, and each packet type is described in a subsequent section.

All OSPF packets (except for Hello packets) forward link-state advertisements. Link-State Update packets, for example, flood advertisements throughout the OSPF routing domain.

- OSPF packet header
- Hello packet
- Database Description packet
- Link-State Request packet
- Link-State Update packet
- Link-State Acknowledgment packet

OSPF Packet Header

Every OSPF packet is preceded by a common 24-byte header. This header contains the information necessary for a receiving router to determine if the packet should be accepted for further processing.

The format of the OSPF packet header is shown below:

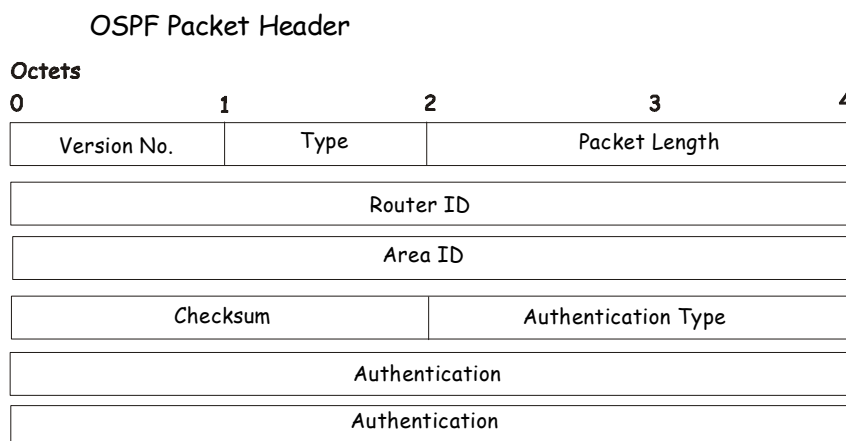

Figure 8- 17. OSPF Packet Header Format

Field	Description
Version No.	The OSPF version number
Type	The OSPF packet type. The OSPF packet types are as follows: Type Description Hello Database Description Link-State Request Link-State Update Link-State Acknowledgment
Packet Length	The length of the packet in bytes. This length includes the 24-byte header.
Router ID	The Router ID of the packet's source.
Area ID	A 32-bit number identifying the area that this packet belongs to. All OSPF packets are associated with a single area. Packets traversing a virtual link are assigned the backbone Area ID of 0.0.0.0
Checksum	A standard IP checksum that includes all of the packet's contents except for the 64-bit authentication field.
Authentication Type	The type of authentication to be used for the packet.
Authentication	A 64-bit field used by the authentication scheme.

Hello Packet

Hello packets are OSPF packet type 1. They are sent periodically on all interfaces, including virtual links, in order to establish and maintain neighbor relationships. In addition, Hello Packets are multicast on those physical networks having a multicast or broadcast capability, enabling dynamic discovery of neighboring routers.

All routers connected to a common network must agree on certain parameters such as the Network Mask, the Hello Interval, and the Router Dead Interval. These parameters are included in the hello packets, so that differences can inhibit the forming of neighbor relationships. A detailed explanation of the receive process for Hello packets is necessary so that differences can inhibit the forming of neighbor relationships.

The format of the Hello packet is shown below:

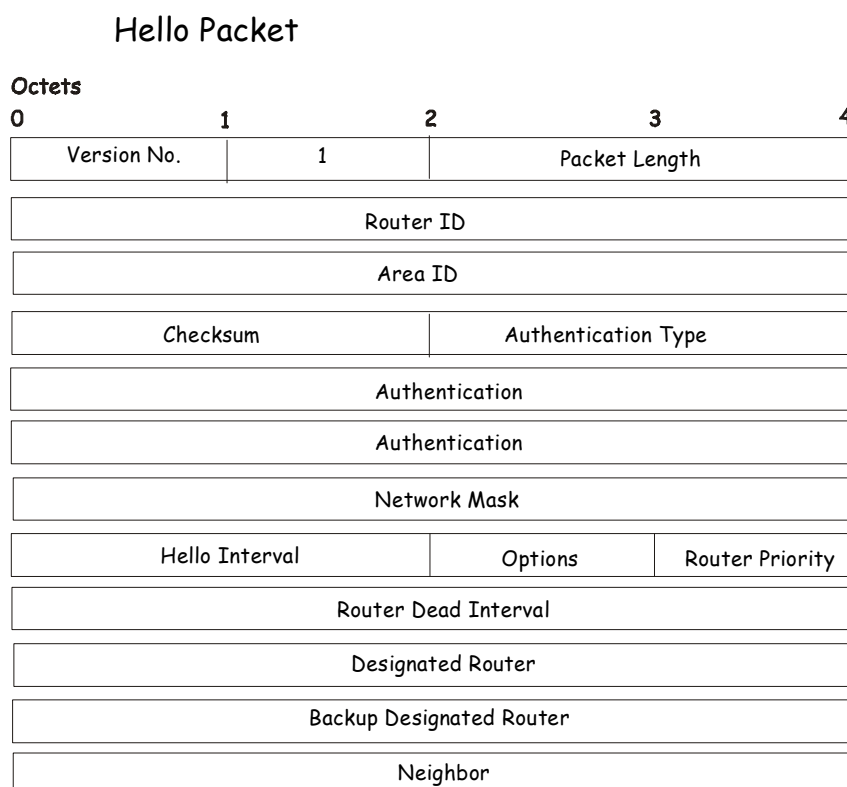

Figure 8- 18. Hello Packet

Field	Description
Network Mask	The network mask associated with this interface.
Options	The optional capabilities supported by the router.
Hello Interval	The number of seconds between this router's Hello packets.
Router Priority	This router's Router Priority. The Router Priority is used in the election of the DR and BDR. If this field is set to 0, the router is ineligible to become the DR or the BDR.
Router Dead Interval	The number of seconds that must pass before declaring a silent router as down.
Designated Router	The identity of the DR for this network, in the view of the advertising router. The DR is identified here by its IP interface address on the network.
Backup Designated Router	The identity of the Backup Designated Router (BDR) for this network. The BDR is identified here by its IP interface address on the network. This field is set to 0.0.0.0 if there is no BDR.
Field	Description
Neighbor	The Router IDs of each router from whom valid Hello packets have been seen within the Router Dead Interval on the network.

Database Description Packet

Database Description packets are OSPF packet type 2. These packets are exchanged when an adjacency is being initialized. They describe the contents of the topological database. Multiple packets may be used to describe the database. For this purpose, a poll-response procedure is used. One of the routers is designated to be master, the other a slave. The master sends Database Description packets (polls) that are acknowledged by Database Description packets sent by the slave (responses). The responses are linked to the polls via the packets' DD sequence numbers.

Database Description Packet

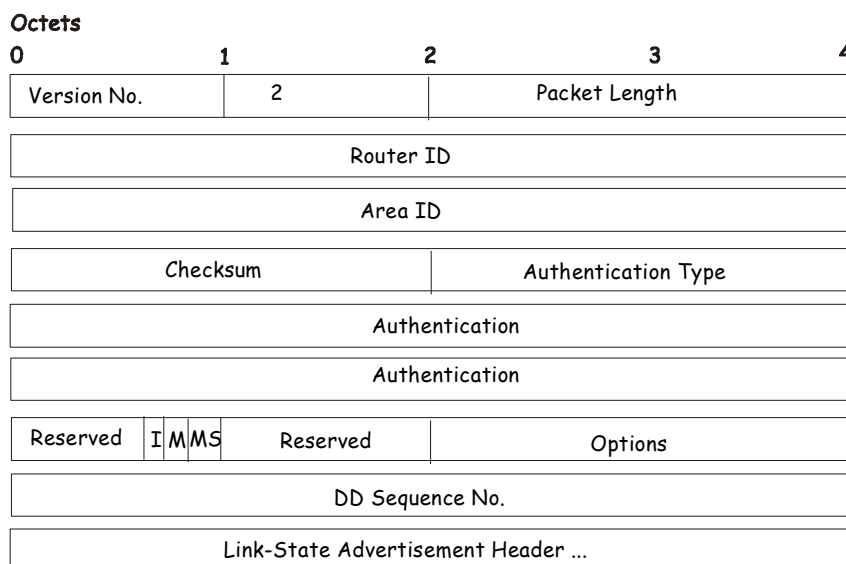

Figure 8- 19. Database Description Packet

Field	Description
Options	The optional capabilities supported by the router.
I - bit	The Initial bit. When set to 1, this packet is the first in the sequence of Database Description packets.
M - bit	The More bit. When set to 1, this indicates that more Database Description packets will follow.
MS - bit	The Master Slave bit. When set to 1, this indicates that the router is the master during the Database Exchange process. A zero indicates the opposite.
DD Sequence Number	User to sequence the collection of Database Description Packets. The initial value (indicated by the Initial bit being set) should be unique. The DD sequence number then increments until the complete database description has been sent.

The rest of the packet consists of a list of the topological database's pieces. Each link state advertisement in the database is described by its link state advertisement header.

Link-State Request Packet

Link-State Request packets are OSPF packet type 3. After exchanging Database Description packets with a neighboring router, a router may find that parts of its topological database are out of date. The Link-State Request packet is used to request the pieces of the neighbor's database that are more up to date. Multiple Link-State Request packets may need to be used. The sending of Link-State Request packets is the last step in bringing up an adjacency.

A router that sends a Link-State Request packet has in mind the precise instance of the database pieces it is requesting, defined by LS sequence number, LS checksum, and LS age, although these fields are not specified in the Link-State Request packet itself. The router may receive even more recent instances in response.

The format of the Link-State Request packet is shown below:

Link-State Request Packet

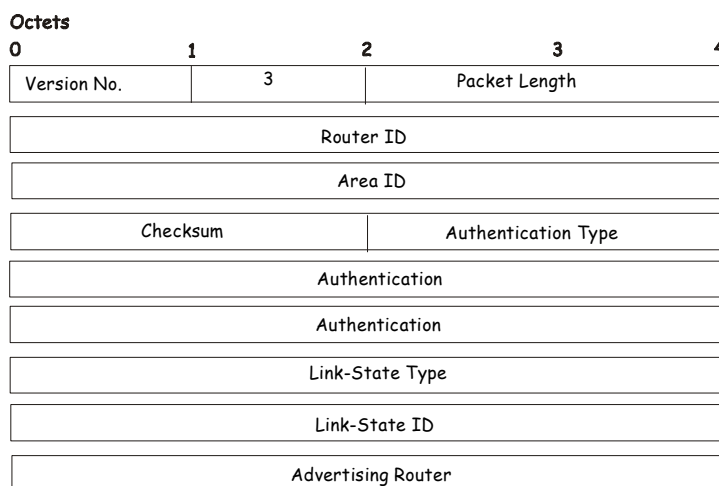

Figure 8- 20. Link-State Request Packet

Each advertisement requested is specified by its Link-State Type, Link-State ID, and Advertising Router. This uniquely identifies the advertisement, but not its instance. Link-State Request packets are understood to be requests for the most recent instance.

Link-State Update Packet

Link-State Update packets are OSPF packet type 4. These packets implement the flooding of link-state advertisements. Each Link-State Update packet carries a collection of link-state advertisements one hop further from its origin. Several link-state advertisements may be included in a single packet.

Link-State Update packets are multicast on those physical networks that support multicast/broadcast. In order to make the flooding procedure reliable, flooded advertisements are acknowledged in Link-State Acknowledgment packets. If retransmission of certain advertisements is necessary, the retransmitted advertisements are always carried by unicast Link-State Update packets.

The format of the Link-State Update packet is shown below:

Link-State Update Packet

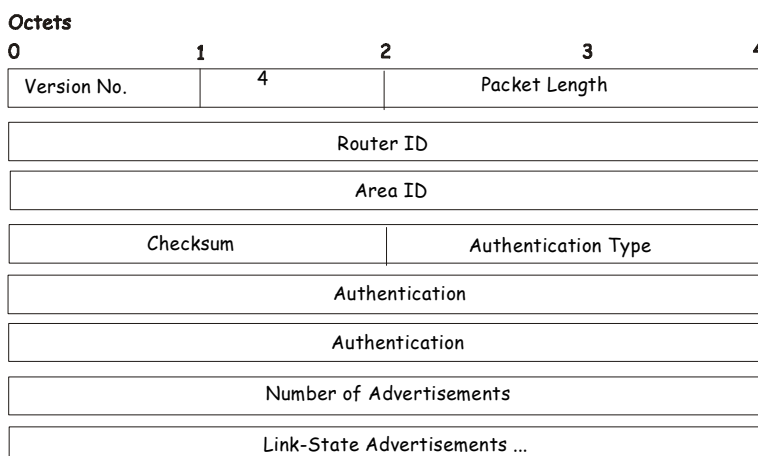

Figure 8- 21. Link-State Update Packet

The body of the Link-State Update packet consists of a list of link-state advertisements. Each advertisement begins with a common 20-byte header, the link-state advertisement header. Otherwise, the format of each of the five types of link-state advertisements is different.

Link-State Acknowledgment Packet

Link-State Acknowledgment packets are OSPF packet type 5. To make the folding of link-state advertisements reliable, flooded advertisements are explicitly acknowledged. This acknowledgment is accomplished through the sending and receiving of Link-State Acknowledgment packets. Multiple link-state advertisements can be acknowledged in a single Link-State Acknowledgment packet.

Depending on the state of the sending interface and the source of the advertisements being acknowledged, a Link-State Acknowledgment packet is sent either to the multicast address AllSPFRouters, to the multicast address AllDRouters, or as a unicast packet.

The format of this packet is similar to that of the Data Description packet. The body of both packets is simply a list of link-state advertisement headers.

The format of the Link-State Acknowledgment packet is shown below:

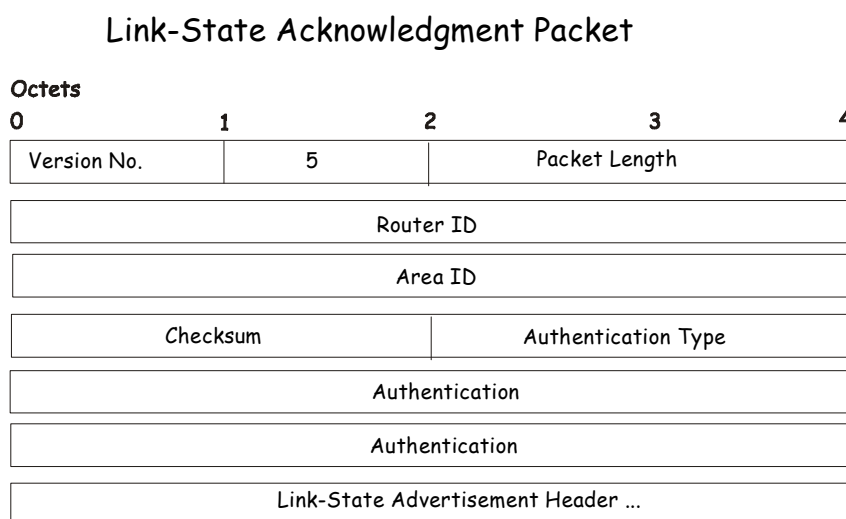

Figure 8- 22. Link State Acknowledge Packet

Each acknowledged link-state advertisement is described by its link-state advertisement header. It contains all the information required to uniquely identify both the advertisement and the advertisement's current instance.

Link-State Advertisement Formats

There are five distinct types of link-state advertisements. Each link-state advertisement begins with a standard 20-byte link-state advertisement header. Succeeding sections then diagram the separate link-state advertisement types.

Each link-state advertisement describes a piece of the OSPF routing domain. Every router originates a router links advertisement. In addition, whenever the router is elected as the Designated Router, it originates a network links advertisement. Other types of link-state advertisements may also be originated. The flooding algorithm is reliable, ensuring that all routers have the same collection of link-state advertisements. The collection of advertisements is called the link-state (or topological) database.

From the link-state database, each router constructs a shortest path tree with itself as root. This yields a routing table.

There are four types of link state advertisements, each using a common link state header. These are:

- Router Links Advertisements
- Network Links Advertisements
- Summary Link Advertisements
- Autonomous System Link Advertisements

Link State Advertisement Header

All link state advertisements begin with a common 20-byte header. This header contains enough information to uniquely identify the advertisements (Link State Type, Link State ID, and Advertising Router). Multiple instances of the link state advertisement may exist in the routing domain at the same time. It is then necessary to determine which instance is more recent. This is accomplished by examining the link state age, link state sequence number and link state checksum fields that are also contained in the link state advertisement header.

The format of the Link State Advertisement Header is shown below:

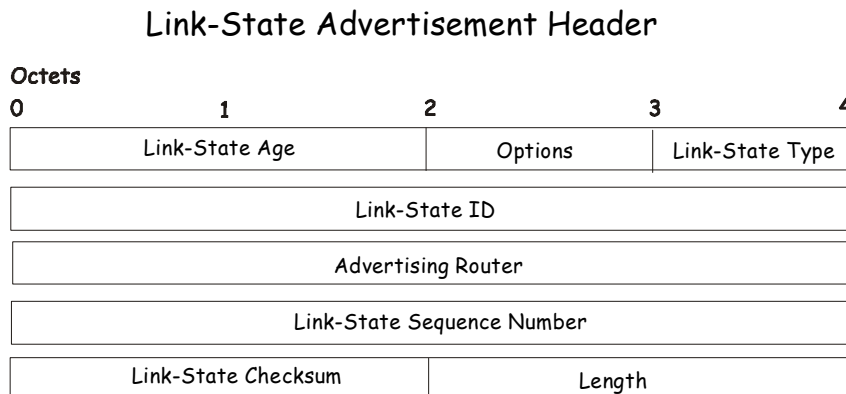

Figure 8- 23. Link State Advertisement Header

Field	Description
Link State Age	The time in seconds since the link state advertisement was originated.
Options	The optional capabilities supported by the described portion of the routing domain.
Link State Type	The type of the link state advertisement. Each link state type has a separate advertisement format. The link state types are as follows: Router Links, Network Links, Summary Link (IP Network), Summary Link (ASBR), AS External Link.
Link State ID	This field identifies the portion of the internet environment that is being described by the advertisement. The contents of this field depend on the advertisement's Link State Type.
Advertising Router	The Router ID of the router that originated the Link State Advertisement. For example, in network links advertisements this field is set to the Router ID of the network's Designated Router.
Link State Sequence Number	Detects old or duplicate link state advertisements. Successive instances of a link state advertisement are given successive Link State Sequence numbers.
Link State Checksum	The Fletcher checksum of the complete contents of the link state advertisement, including the link state advertisement header by accepting the Link State Age field.
Length	The length in bytes of the link state advertisement. This includes the 20-byte link state advertisement header.

Router Links Advertisements

Router links advertisements are type 1 link state advertisements. Each router in an area originates a routers links advertisement. The advertisement describes the state and cost of the router’s links to the area. All of the router’s links to the area must be described in a single router links advertisement.

The format of the Router Links Advertisement is shown below:

Routers Links Advertisements

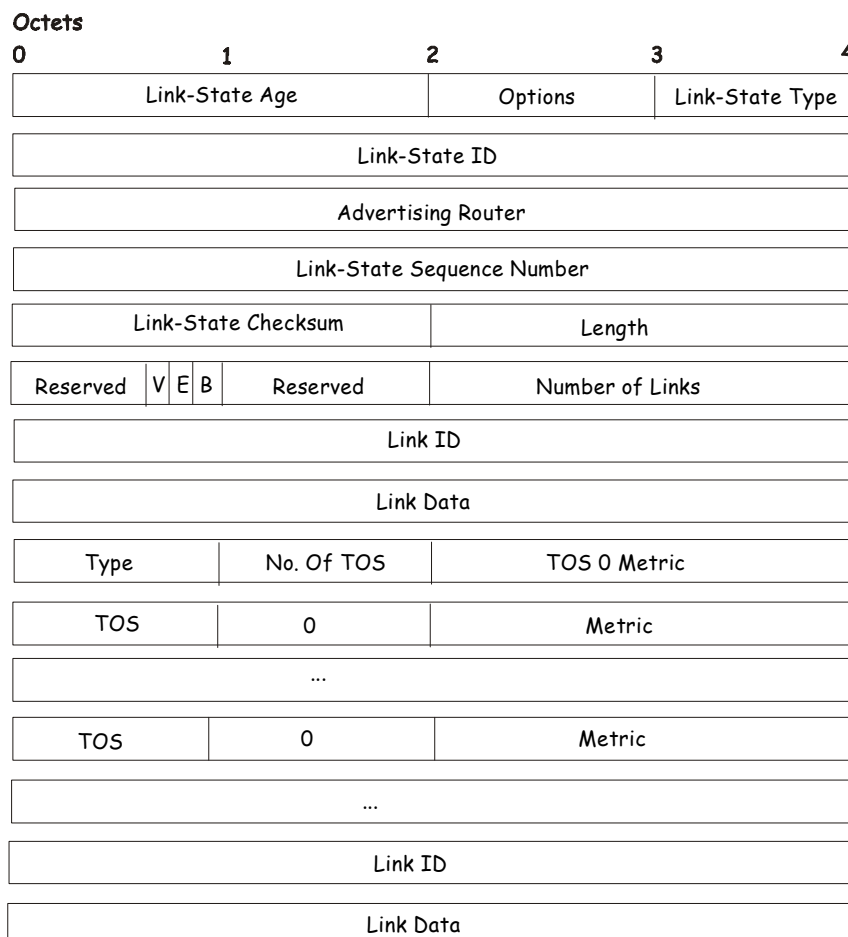

Figure 8- 24. Routers Links Advertisements

In router links advertisements, the Link State ID field is set to the router’s OSPF Router ID. The T - bit is set in the advertisement’s Option field if and only if the router is able to calculate a separate set of routes for each IP Type of Service (TOS). Router links advertisements are flooded throughout a single area only.

Field	Description
V - bit	When set, the router is an endpoint of an active virtual link that is using the described area as a Transit area (V is for Virtual link endpoint).
E - bit	When set, the router is an Autonomous System (AS) boundary router (E is for External).
B - bit	When set, the router is an area border router (B is for Border).
Number of Links	The number of router links described by this advertisement. This must be the total collection of router links to the area.

The following fields are used to describe each router link. Each router link is typed. The Type field indicates the kind of link being described. It may be a link to a transit network, to another router or to a stub network. The values of all the other fields describing

a router link depend on the link's Type. For example, each link has an associated 32-bit data field. For links to stub networks, this field specifies the network's IP address mask. For other link types, the Link Data specifies the router's associated IP interface address.

Field	Description
Type	A quick classification of the router link. One of the following: Type Description Point-to-point connection to another router. Connection to a transit network. Connection to a stub network. Virtual link.
Link ID	Identifies the object that this router link connects to. Value depends on the link's Type. When connecting to an object that also originates a link state advertisement (i.e. another router or a transit network) the Link ID is equal to the neighboring advertisement's Link State ID. This provides the key for looking up an advertisement in the link state database. Type Link ID Neighboring router's Router ID. IP address of Designated Router. IP network/subnet number. Neighboring router's Router ID
Link Data	Contents again depend on the link's Type field. For connections to stub networks, it specifies the network's IP address mask. For unnumbered point-to-point connection, it specifies the interface's MIB-II ifIndex value. For other link types it specifies the router's associated IP interface address. This latter piece of information is needed during the routing table build process, when calculating the IP address of the next hop.
No. of TOS	The number of different Type of Service (TOS) metrics given for this link, not counting the required metric for TOS 0. If no additional TOS metrics are given, this field should be set to 0.
TOS 0 Metric	The cost of using this router link for TOS 0.

For each link, separate metrics may be specified for each Type of Service (TOS). The metric for TOS 0 must always be included, and was discussed above. Metrics for non-zero TOS are described below. Note that the cost for non-zero TOS values that are not specified defaults to the TOS 0 cost. Metrics must be listed in order of increasing TOS encoding. For example, the metric for TOS 16 must always follow the metric for TOS 8 when both are specified.

Field	Description
TOS	IP Type of Service that this metric refers to.
Metric	The cost of using this outbound router link, for traffic of the specified TOS.

Network Links Advertisements

Network links advertisements are Type 2 link state advertisements. A network links advertisement is originated for each transit network in the area. A transit network is a multi-access network that has more than one attached router. The network links advertisement is originated by the network's Designated router. The advertisement describes all routers attached to the network, including the Designated Router itself. The advertisement's Link State ID field lists the IP interface address of the Designated Router.

The distance from the network to all attached routers is zero, for all TOS. This is why the TOS and metric fields need not be specified in the network links advertisement.

The format of the Network Links Advertisement is shown below:

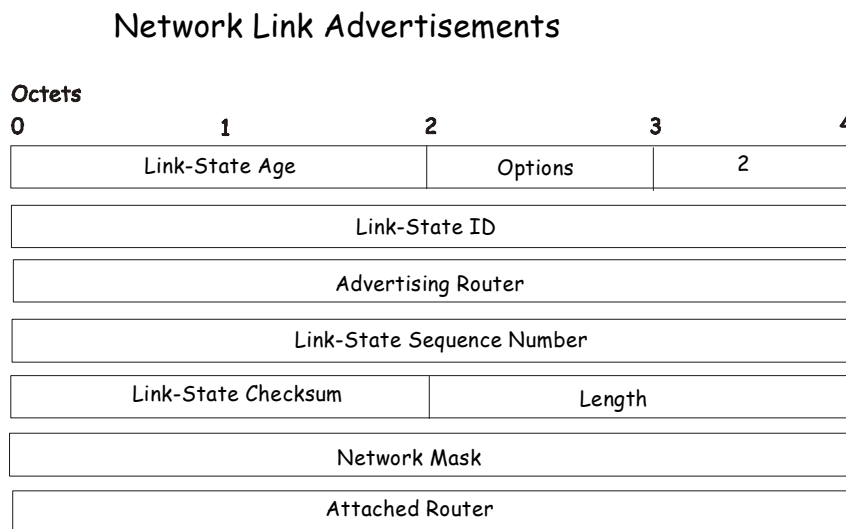

Figure 8- 25. Network Link Advertisements

Field	Description
Network Mask	The IP address mask for the network.
Attached Router	The Router Ids of each of the routers attached to the network. Only those routers that are fully adjacent to the Designated Router (DR) are listed. The DR includes itself in this list.

Summary Link Advertisements

Summary link advertisements are Type 3 and 4 link state advertisements. These advertisements are originated by Area Border routers. A separate summary link advertisement is made for each destination known to the router, that belongs to the Autonomous System (AS), yet is outside the area.

Type 3 link state advertisements are used when the destination is an IP network. In this case, the advertisement's Link State ID field is an IP network number. When the destination is an AS boundary router, a Type 4 advertisement is used, and the Link State ID field is the AS boundary router's OSPF Router ID. Other than the difference in the Link State ID field, the format of Type 3 and 4 link state advertisements is identical.

Summary Link Advertisements

Octets	0	1	2	3	4
	Link-State Age		Options		2
	Link-State ID				
	Advertising Router				
	Link-State Sequence Number				
	Link-State Checksum		Length		
	Network Mask				
	TOS	Metric			

Figure 8- 26. Summary Link Advertisements

For stub area, Type 3 summary link advertisements can also be used to describe a default route on a per-area basis. Default summary routes are used in stub area instead of flooding a complete set of external routes. When describing a default summary route, the advertisement's Link State ID is always set to the Default Destination – 0.0.0.0, and the Network Mask is set to 0.0.0.0.

Separate costs may be advertised for each IP Type of Service. Note that the cost for TOS 0 must be included, and is always listed first. If the T-bit is reset in the advertisement's Option field, only a route for TOS 0 is described by the advertisement. Otherwise, routes for the other TOS values are also described. If a cost for a certain TOS is not included, its cost defaults to that specified for TOS 0.

Field	Description
Network Mask	For Type 3 link state advertisements, this indicates the destination network's IP address mask. For example, when advertising the location of a class A network the value 0xff000000
TOS	The Type of Service that the following cost is relevant to.
Metric	The cost of this route. Expressed in the same units as the interface costs in the router links advertisements.

Autonomous Systems External Link Advertisements

Autonomous Systems (AS) link advertisements are Type 5 link state advertisements. These advertisements are originated by AS boundary routers. A separate advertisement is made for each destination known to the router that is external to the AS.

AS external link advertisements usually describe a particular external destination. For these advertisements the Link State ID field specifies an IP network number. AS external link advertisements are also used to describe a default route. Default routes are used when no specific route exists to the destination. When describing a default route, the Link Stat ID is always set the Default Destination address (0.0.0.0) and the Network Mask is set to 0.0.0.0.

The format of the AS External Link Advertisement is shown below:

AS External Link Advertisements

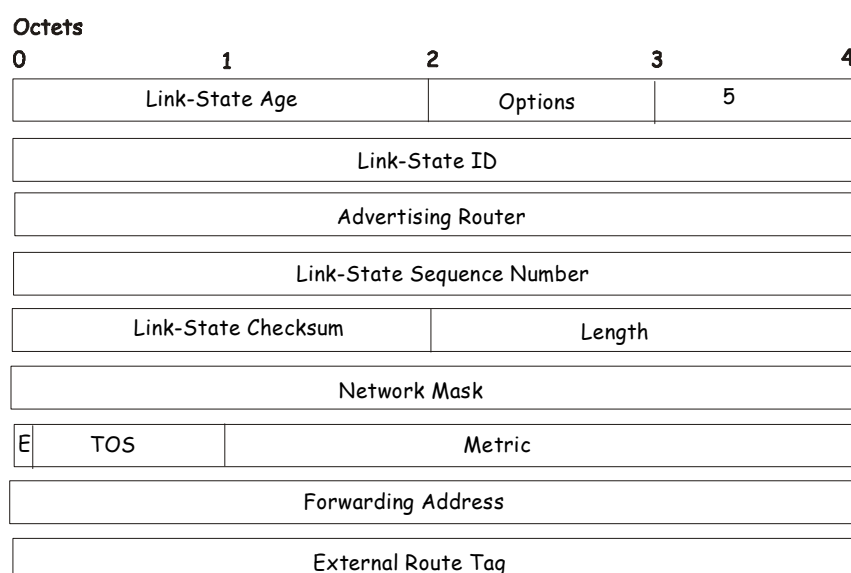

Figure 8- 27. AS External Link Advertisements

Field	Description
Network Mask	The IP address mask for the advertised destination.
E - bit	The type of external metric. If the E - bit is set, the metric specified is a Type 2 external metric. This means the metric is considered larger than any link state path. If the E - bit is zero, the specified metric is a Type 1 external metric. This means that is comparable directly to the link state metric.
Forwarding Address	Data traffic for the advertised destination will be forwarded to this address. If the Forwarding Address is set to 0.0.0.0, data traffic will be forwarded instead to the advertisement's originator.
TOS	The Type of Service that the following cost is relevant to.
Metric	The cost of this route. The interpretation of this metric depends on the external type indication (the E - bit above).
External Route Tag	A 32-bit field attached to each external route. This is not used by the OSPF protocol itself.

OSPF Global Settings

The **OSPF Global Settings** menu allows OSPF to be enabled or disabled on the Switch – without changing the Switch’s OSPF configuration. To view the following window, click **L3 Features > OSPF > OSPF Global Settings**. To enable OSPF, first supply an **OSPF Route ID** (see below), select *Enabled* from the **State** drop-down menu and click the **Apply** button.

Figure 8- 28. OSPF Global Settings window

The following parameters are used for general OSPF configuration:

Parameter	Description
OSPF Route ID	A 32-bit number (in the same format as an IP address – xxx.xxx.xxx.xxx) that uniquely identifies the Switch in the OSPF domain. It is common to assign the highest IP address assigned to the Switch (router). In this case, it would be 10.53.13.189, but any unique 32-bit number will do. If 0.0.0.0 is entered, the highest IP address assigned to the Switch will become the OSPF Route ID.
Current Route ID	Displays the OSPF Route ID currently in use by the Switch. This Route ID is displayed as a convenience to the user when changing the Switch’s OSPF Route ID.
State	Allows OSPF to be enabled or disabled globally on the Switch without changing the OSPF configuration.

OSPF Area Setting

This menu allows the configuration of OSPF Area IDs and to designate these areas as either **Normal** or **Stub**. Normal OSPF areas allow Link-State Database (LSDB) advertisements of routes to networks that are external to the area. Stub areas do not allow the LSDB advertisement of external routes. Stub areas use a default summary external route (0.0.0.0 or Area 0) to reach external destinations.

To set up an OSPF area configuration click **Layer 3 Features > OSPF > OSPF Area Settings** link to open the following dialog box:

Figure 8- 29. OSPF Area Settings and Table window

To add an OSPF Area to the table, type a unique **Area ID** (see below) select the **Type** from the drop-down menu. For a Stub type, choose *Enabled* or *Disabled* from the **Stub Import Summary LSA** drop-down menu and determine the **Stub Default Cost**. Click the **Add/Modify** button to add the area ID set to the table.

To remove an Area ID configuration set, simply click  in the **Delete** column for the configuration.

To change an existing set in the list, type the **Area ID** of the set you want to change, make the changes and click the **Add/Modify** button. The modified OSPF area ID will appear in the table.

OSPF Area Settings				
Area ID	Type	Stub Import Summary LSA	Stub Default Cost	
0.0.0.0	Normal	Disabled	1	
				Add/Modify
OSPF Area Table				
Area ID	Type	Stub Import Summary LSA	Stub Default Cost	Delete
0.0.0.0	Normal	None	None	✕
32.0.0.0	Normal	None	None	✕

Figure 8- 30. OSPF Area Settings example window

See the parameter descriptions below for information on the **OSPF Area ID Settings**.

The **Area ID** settings are as follows:

Parameter	Description
Area ID	A 32-bit number in the form of an IP address (xxx.xxx.xxx.xxx) that uniquely identifies the OSPF area in the OSPF domain.
Type	This field can be toggled between <i>Normal</i> and <i>Stub</i> using the space bar. When it is toggled to <i>Stub</i> , additional fields appear – Stub Import Summary LSA , and the Stub Default Cost .
Stub Import Summary LSA	Displays whether or not the selected Area will allow Summary Link-State Advertisements (Summary LSAs) to be imported into the area from other areas.
Stub Default Cost	Displays the default cost for the route to the stub of between 0 and 65,535. The default is 1.

OSPF Interface Settings

To set up OSPF interfaces, click **L3 Features > OSPF > OSPF Interface Settings** to view OSPF settings for existing IP interfaces. If there are no IP interfaces configured (besides the default System interface), only the System interface settings will appear listed. To change settings for in IP interface, click on the hyperlinked name of the interface to see the configuration menu for that interface.

OSPF Interface Settings					
Interface Name	IP Address	Area ID	Auth. Type	State	Metric
n10	10.20.6.251	0.0.0.0	None	Enabled	1
n11	11.1.1.251	32.0.0.0	None	Enabled	1
n21	21.1.1.251	0.0.0.0	None	Enabled	1
n31	31.1.1.251	32.0.0.0	None	Enabled	1
n41	41.1.1.251	0.0.0.0	None	Enabled	1
n1921	192.1.1.251	0.0.0.0	None	Enabled	1
n2001	201.1.1.1	0.0.0.0	None	Enabled	1
n2002	201.2.1.1	0.0.0.0	None	Enabled	1
n2003	201.3.1.1	0.0.0.0	None	Enabled	1
n2004	201.4.1.1	0.0.0.0	None	Enabled	1
n2005	201.5.1.1	0.0.0.0	None	Enabled	1
n2006	201.6.1.1	0.0.0.0	None	Enabled	1
n2007	201.7.1.1	0.0.0.0	None	Enabled	1
n2008	201.8.1.1	0.0.0.0	None	Enabled	1
System	211.1.1.251	0.0.0.0	None	Enabled	1
Testtesttest	223.255.255.254	0.0.0.0	None	Enabled	1

Figure 8- 31. OSPF Interface Settings window

OSPF Interface Settings - Edit	
Interface Name	System
IP Address	10.53.13.52(Link Up)
Network Medium Type	BROADCAST
Area ID	0.0.0.0
Router Priority(0-255)	1
Hello Interval(1-65535)	10
Dead Interval(1-65535)	40
State	Disabled
Auth. Type	None
Password/Auth. Key ID	
Metric(1-65535)	1
DR State	DOWN
DR Address	0.0.0.0
Backup DR Address	0.0.0.0
Transmit Delay	1
Retransmit Time	5
Active/Passive Interface	Active

[Show All OSPF Interface Entries](#)

Figure 8- 32. OSPF Interface Settings - Edit window

Configure each IP interface individually using the **OSPF Interface Settings - Edit** menu. Click the **Apply** button when you have entered the settings. The new configuration appears listed in the **OSPF Interface Settings** table. To return to the **OSPF Interface Settings** table, click the [Show All OSPF Interface Entries](#) link.

OSPF interface settings are described below. Some OSPF interface settings require previously configured OSPF settings. Read the descriptions below for details.

Parameter	Description
Interface Name	Displays the of an IP interface previously configured on the Switch.
Area ID	Allows the entry of an OSPF Area ID configured above.
Router Priority (0-255)	Allows the entry of a number between 0 and 255 representing the OSPF priority of the selected area. If a Router Priority of 0 is selected, the Switch cannot be elected as the Designated Router for the network.
Hello Interval (1-65535)	Allows the specification of the interval between the transmissions of OSPF Hello packets, in seconds. Between 1 and 65535 seconds can be specified. The Hello Interval , Dead Interval , Authorization Type , and Authorization Key should be the same for all routers on the same network.
Dead Interval (1-65535)	Allows the specification of the length of time between the receipt of Hello packets from a neighbor router before the selected area declares that router down. An interval between 1 and 65535 seconds can be specified. The Dead Interval must be evenly divisible by the Hello Interval .
State	Allows the OSPF interface to be disabled for the selected area without changing the configuration for that area.
Auth Type	<p>This field can be toggled between None, Simple, and MD5 using the space bar. This allows a choice of authorization schemes for OSPF packets that may be exchanged over the OSPF routing domain.</p> <ul style="list-style-type: none"> • None specifies no authorization. • Simple uses a simple password to determine if the packets are from an authorized OSPF router. When Simple is selected, the Auth Key field allows the entry of an 8-character password that must be the same as a password configured on a neighbor OSPF router. • MD5 uses a cryptographic key entered in the MD5 Key Table Configuration menu. When MD5 is selected, the Auth Key ID field allows the specification of the Key ID as defined in the MD5 configuration above. This must be the same MD5 Key as used by the neighboring router.
Password/Auth. Key ID	Enter a Key ID of up to 5 characters to set the Auth. Key ID for either the Simple Auth Type or the MD5 Auth Type, as specified in the previous parameter.
Metric (1-65535)	This field allows the entry of a number between 1 and 65,535 that is representative of the OSPF cost of reaching the selected OSPF interface. The default metric is 1.
DR State	A read only field describing the Designated Router state of the IP interface. This field may read DR if the interface is the designated router, or Backup DR if the interface is the Backup Designated Router. The highest IP address will be the Designated Router and is determined by the OSPF Hello Protocol of the Switch.
DR Address	The IP address of the aforementioned Designated Router.
Backup DR Address	The IP address of the aforementioned Backup Designated Router.
Transmit Delay	A read only field that denotes the estimated time to transmit a Link State Update Packet over this interface, in seconds.

Retransmit Time	A read only field that denotes the time between LSA retransmissions over this interface, in seconds.
Active or Passive Interface	The user may select Active or Passive for this OSPF interface. Active interfaces actively advertise OSPF to routers on other Intranets that are not part of this specific OSPF group. Passive interface will not advertise to any other routers than those within its OSPF intranet.

OSPF Virtual Link Settings

Click the **OSPF Virtual Interface Settings** link to view the current **OSPF Virtual Interface Settings**. There are not virtual interface settings configured by default, so the first time this table is viewed there will be not interfaces listed. To add a new OSPF virtual interface configuration set to the table, click the **Add** button. A new menu appears (see below). To change an existing configuration, click on the hyperlinked **Transit Area ID** for the set you want to change. The menu to modify an existing set is the same as the menu used to add a new one. To eliminate an existing configuration, click the **X** in the **Delete** column.

OSPF Virtual Link Settings								
Transit Area ID	Neighbor Router ID	Hello Interval	Dead Interval	Auth. Type	Transmit Delay	Retransmit Interval	Status	Delete
32.0.0.0	3.0.0.0	10	60	None	1	5	Down	X

Figure 8- 33. OSPF Virtual Interface Settings

The status of the virtual interface appears (Up or Down) in the **Status** column.

OSPF Virtual Link Settings - Add	
Transit Area ID	<input type="text" value="0.0.0.0"/>
Neighbor Router ID	<input type="text" value="0.0.0.0"/>
Hello Interval(1-65535)	<input type="text" value="10"/>
Dead Interval(1-65535)	<input type="text" value="60"/>
Auth Type	<input type="text" value="None"/>
Password/Auth. Key ID	<input type="text"/>
Transmit Delay	<input type="text" value="1"/>
Retransmit Interval	<input type="text" value="5"/>

[Show All OSPF Virtual Link Entries](#)

Figure 8- 34. OSPF Virtual Link Settings – Add

OSPF Virtual Link Settings - Edit	
Transit Area ID	<input type="text" value="32.0.0.0"/>
Neighbor Router ID	<input type="text" value="3.0.0.0"/>
Hello Interval(1-65535)	<input type="text" value="10"/>
Dead Interval(1-65535)	<input type="text" value="60"/>
Auth Type	None <input type="button" value="v"/>
Password/Auth. Key ID	<input type="text"/>
Transmit Delay	<input type="text" value="1"/>
Retransmit Interval	<input type="text" value="5"/>
<input type="button" value="Apply"/>	
Show All OSPF Virtual Link Entries	

Figure 8- 35. OSPF Virtual Link Settings - Edit

Configure the following parameters if you are adding or changing an **OSPF Virtual Interface**:

Parameter	Description
Transit Area ID	Allows the entry of an OSPF Area ID – previously defined on the Switch – that allows a remote area to communicate with the backbone (area 0). A Transit Area cannot be a Stub Area or a Backbone Area.
Neighbor Router	The OSPF router ID for the remote router. This is a 32-bit number in the form of an IP address (xxx.xxx.xxx.xxx) that uniquely identifies the remote area's Area Border Router.
Hello Interval (1-65535)	Specify the interval between the transmission of OSPF Hello packets, in seconds. Enter a value between 1 and 65535 seconds. The Hello Interval , Dead Interval , Authorization Type , and Authorization Key should have identical settings for all routers on the same network.
Dead Interval (1-65535)	Specify the length of time between (receiving) Hello packets from a neighbor router before the selected area declares that router down. Again, all routers on the network should use the same setting.
Auth Type	If using authorization for OSPF routers, select the type being used. MD5 key authorization must be set up in the MD5 Key Settings menu.
Password/Auth. Key ID	Enter a case-sensitive password for simple authorization or enter the MD5 key you set in the MD5 Key settings menu.
Transmit Delay	The number of seconds required to transmit a link state update over this virtual link. Transit delay takes into account transmission and propagation delays. This field is fixed at 1 second.
RetransInterval	The number of seconds between link state advertisement retransmissions for adjacencies belonging to this virtual link. This field is fixed at 5 seconds.

Click **Apply** to implement changes made.



NOTE: For OSPF to function properly some settings should be identical on all participating OSPF devices. These settings include the Hello Interval and Dead Interval. For networks using authorization for OSPF devices, the Authorization Type and Password or Key used must likewise be identical.

OSPF Area Aggregation Settings

Area Aggregation allows all of the routing information that may be contained within an area to be aggregated into a summary LSDB advertisement of just the network address and subnet mask. This allows for a reduction in the volume of LSDB advertisement traffic as well as a reduction in the memory overhead in the Switch used to maintain routing tables. Click **Layer 3 Features > OSPF > OSPF Area Aggregation Settings** link to view the current settings. There are no aggregation settings configured by default, so there will not be any listed the first accessing the menu. To add a new **OSPF Area Aggregation** setting, click the **Add** button. A new menu (pictured below) appears. To change an existing configuration, click on the hyperlinked Area ID for the set you want to change. The menu to modify an existing configuration is the same as the menu used to add a new one. To eliminate an existing configuration, click the **X** in the **Delete** column for the configuration being removed.

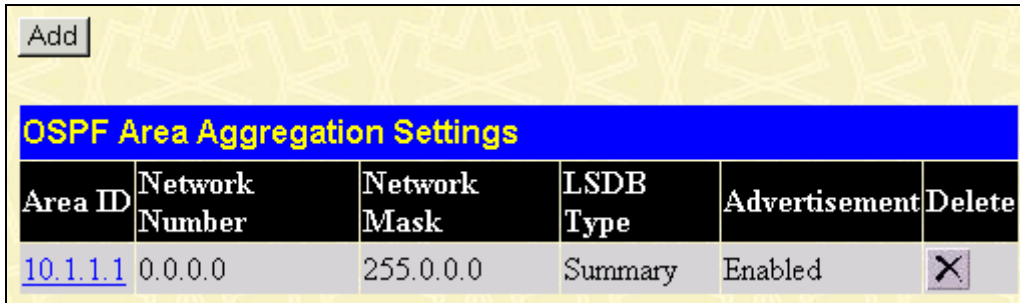

OSPF Area Aggregation Settings					
Area ID	Network Number	Network Mask	LSDB Type	Advertisement	Delete
10.1.1.1	0.0.0.0	255.0.0.0	Summary	Enabled	X

Figure 8- 36. OSPF Area Aggregation Settings

Use the menu below to change settings or add a new **OSPF Area Aggregation** setting.

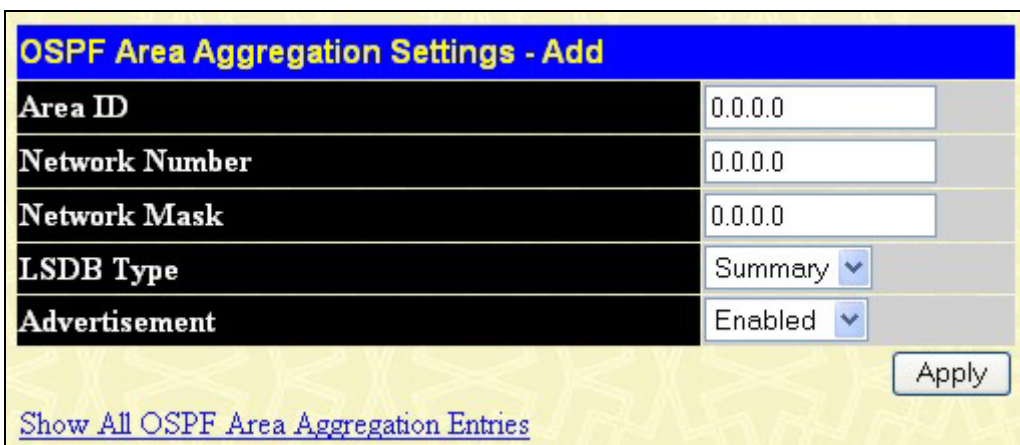

OSPF Area Aggregation Settings - Add	
Area ID	<input type="text" value="0.0.0.0"/>
Network Number	<input type="text" value="0.0.0.0"/>
Network Mask	<input type="text" value="0.0.0.0"/>
LSDB Type	Summary ▾
Advertisement	Enabled ▾
<input type="button" value="Apply"/>	
Show All OSPF Area Aggregation Entries	

Figure 8- 37. OSPF Area Aggregation Settings - Add

Specify the OSPF aggregation settings and click the **Apply** button to add or change the settings. The new settings will appear listed in the **OSPF Area Aggregation Settings** table. To view the table, click the [Show All OSPF Area Aggregation Entries](#) link to return to the previous window.

Use the following parameters to configure the following settings for **OSPF Area Aggregation Settings**:

Parameter	Description
Area ID	Allows the entry the OSPF Area ID for which the routing information will be aggregated. This Area ID must be previously defined on the Switch.
Network Number	Sometimes called the Network Address. The 32-bit number in the form of an IP address that uniquely identifies the network that corresponds to the OSPF Area above.
Network Mask	The corresponding network mask for the Network Number specified above.
LSDB Type	Specifies the type of address aggregation, which is set at <i>Summary</i> .
Advertisement	Select <i>Enabled</i> or <i>Disabled</i> to determine whether the selected OSPF Area will advertise it's summary LSDB (Network-Number and Network-Mask).

Click **Apply** to implement changes made.

OSPF Host Route Settings

OSPF host routes work in a way analogous to RIP, only this is used to share OSPF information with other OSPF routers. This is used to work around problems that might prevent OSPF information sharing between routers. To configure OSPF host routes, click the **OSPF Host Route Settings** link. To add a new OSPF Route, click the **Add** button. Configure the setting in the menu that appears. The **Add** and **Modify** menus for OSPF host route setting are nearly identical. The difference being that if you are changing an existing configuration you will be unable to change the **Host Address**. To change an existing configuration, click on the hyperlinked **Host Address** in the list for the configuration to change and proceed to change the metric or area ID. To eliminate an existing configuration, click the in the **Delete** column for the configuration being removed.

OSPF Host Route Settings			
Host Address	Metric	Area ID	Delete
10.1.1.1	2	224.0.0.1	<input checked="" type="checkbox"/>

Figure 8- 38. OSPF Host Route Settings table

Use the menus below to add or edit OSPF host routes.

OSPF Host Route Settings - Add

Host Address	<input type="text" value="0.0.0.0"/>
Metric (1-65535)	<input type="text" value="0"/>
Area ID	<input type="text" value="0.0.0.0"/>

[Show All OSPF Host Route Entries](#)

Figure 8- 39. OSPF Host Route Settings - Add

OSPF Host Route Settings - Edit

Host Address	<input type="text" value="10.1.1.1"/>
Metric (1-65535)	<input type="text" value="2"/>
Area ID	<input type="text" value="224.0.0.1"/>

[Show All OSPF Host Route Entries](#)

Figure 8- 40. OSPF Host Route Settings - Edit

Specify the host route settings and click the **Apply** button to add or change the settings. The new settings will appear listed in the **OSPF Host Route Settings** list. To view the previous window, click the [Show All OSPF Host Route Entries](#) link to return to the previous window.

The following fields are configured for OSPF host route:

Parameter	Description
Host Address	The IP address of the OSPF host.
Metric	A value between 1 and 65535 that will be advertised for the route.
Area ID	A 32-bit number in the form of an IP address (xxx.xxx.xxx.xxx) that uniquely identifies the OSPF area in the OSPF domain.

DHCP/BOOTP Relay

The relay hops count limit allows the maximum number of hops (routers) that the DHCP/BOOTP messages can be relayed through to be set. If a packet's hop count is more than the hop count limit, the packet is dropped. The range is between 1 and 16 hops, with a default value of 4. The relay time threshold sets the minimum time (in seconds) that the Switch will wait before forwarding a BOOTREQUEST packet. If the value in the seconds field of the packet is less than the relay time threshold, the packet will be dropped. The range is between 0 and 65,536 seconds, with a default value of 0 seconds.

DHCP / BOOTP Relay Global Settings

To enable and configure DHCP/BOOTP Relay Global Settings on the Switch, click **L3 Features > DHCP/BOOTP Relay > DHCP/BOOTP Relay Global Settings**:

DHCP/BOOTP Relay Global Settings	
BOOTP Relay State	Disabled ▾
BOOTP Relay Hops Count Limit (1-16)	4
BOOTP Relay Time Threshold (0-65535)	0
DHCP Relay Agent Information Option 82 State	Disabled ▾
DHCP Relay Agent Information Option 82 Check	Disabled ▾
DHCP Relay Agent Information Option 82 Policy	Replace ▾
Apply	

Figure 8- 41. DHCP/ BOOTP Relay Global Settings window

The following fields can be set:

Parameter	Description
Relay State	This field can be toggled between <i>Enabled</i> and <i>Disabled</i> using the pull-down menu. It is used to enable or disable the DHCP/BOOTP Relay service on the Switch. The default is <i>Disabled</i> .
Relay Hops Count Limit (1-16)	This field allows an entry between 1 and 16 to define the maximum number of router hops DHCP/BOOTP messages can be forwarded across. The default hop count is 4.
Relay Time Threshold (0-65535)	Allows an entry between 0 and 65535 seconds, and defines the maximum time limit for routing a DHCP/BOOTP packet. If a value of 0 is entered, the Switch will not process the value in the seconds field of the BOOTP or DHCP packet. If a non-zero value is entered, the Switch will use that value, along with the hop count to determine whether to forward a given BOOTP or DHCP packet.
DHCP Agent Information Option 82 State	<p>This field can be toggled between <i>Enabled</i> and <i>Disabled</i> using the pull-down menu. It is used to enable or disable the DHCP Agent Information Option 82 on the Switch. The default is <i>Disabled</i>.</p> <p><i>Enabled</i> –When this field is toggled to <i>Enabled</i> the relay agent will insert and remove DHCP relay information (option 82 field) in messages between DHCP servers and clients. When the relay agent receives the DHCP request, it adds the option 82 information, and the IP address of the relay agent (if the relay agent is configured), to the packet. Once the option 82 information has been added to the packet it is sent on to the DHCP server. When the DHCP server receives the packet, if the server is capable of option 82, it can implement policies like restricting the number of IP addresses that can be assigned to a single remote ID or circuit ID. Then the DHCP server echoes the option 82 field in the DHCP reply. The DHCP server unicasts the reply to the back to the relay agent if the request was relayed to the server by the relay agent. The switch verifies that it originally inserted the option 82 data. Finally, the relay agent removes the option 82 field and forwards the packet to the switch port that connects to the DHCP client that sent the DHCP request.</p> <p><i>Disabled</i>- If the field is toggled to <i>Disabled</i> the relay agent will not insert and remove DHCP relay information (option 82 field) in messages between DHCP servers and clients, and the check and policy settings will have no effect.</p>

<p>DHCP Agent Information Option 82 Check</p>	<p>This field can be toggled between <i>Enabled</i> and <i>Disabled</i> using the pull-down menu. It is used to enable or disable the Switches ability to check the validity of the packet's option 82 field.</p> <p><i>Enabled</i>– When the field is toggled to <i>Enable</i>, the relay agent will check the validity of the packet's option 82 field. If the switch receives a packet that contains the option-82 field from a DHCP client, the switch drops the packet because it is invalid. In packets received from DHCP servers, the relay agent will drop invalid messages.</p> <p><i>Disabled</i>- When the field is toggled to <i>Disabled</i>, the relay agent will not check the validity of the packet's option 82 field.</p>
<p>DHCP Agent Information Option 82 Policy</p>	<p>This field can be toggled between <i>Replace</i>, <i>Drop</i>, and <i>Keep</i> by using the pull-down menu. It is used to set the Switches policy for handling packets when the DHCP Agent Information Option 82 Check is set to <i>Disabled</i>. The default is <i>Replace</i>.</p> <p><i>Replace</i> - The option 82 field will be replaced if the option 82 field already exists in the packet received from the DHCP client.</p> <p><i>Drop</i> - The packet will be dropped if the option 82 field already exists in the packet received from the DHCP client.</p> <p><i>Keep</i> - The option 82 field will be retained if the option 82 field already exists in the packet received from the DHCP client.</p>

Click **Apply** to implement any changes that have been made.



NOTE: If the switch receives a packet that contains the option-82 field from a DHCP client and the information-checking feature is enabled, the switch drops the packet because it is invalid. However, in some instances, you might configure a client with the option-82 field. In this situation, you should disable the information-check feature so that the switch does not remove the option-82 field from the packet. You can configure the action that the switch takes when it receives a packet with existing option-82 information by configuring the **DHCP Agent Information Option 82 Policy**.

The Implementation of DHCP Information Option 82 in DES-3828P/DES-3828DC

The `config dhcp_relay option_82` command configures the DHCP relay agent information option 82 setting of the switch. The formats for the circuit ID sub-option and the remote ID sub-option are as follows:



NOTE: For the circuit ID sub-option of a standalone switch, the module field is always zero.

Circuit ID sub-option format:

1. 2. 3. 4. 5. 6. 7.

1	6	0	4	VLAN	Module	Port
---	---	---	---	------	--------	------

1 byte 1 byte 1 byte 1 byte 2 bytes 1 byte 1 byte

- a. Sub-option type
- b. Length
- c. Circuit ID type
- d. Length
- e. VLAN: the incoming VLAN ID of DHCP client packet.
- f. Module: For a standalone switch, the Module is always 0; For a stackable switch, the Module is the Unit ID.
- g. Port: The incoming port number of DHCP client packet, port number starts from 1.

Remote ID sub-option format:

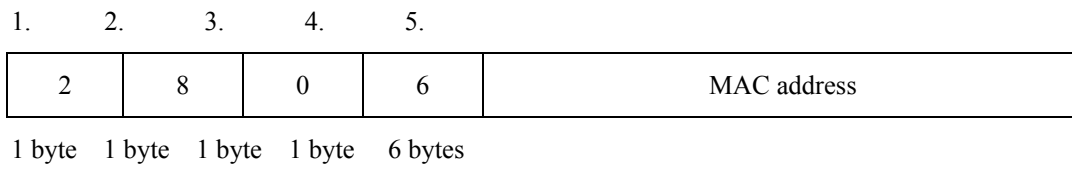

1. Sub-option type
2. Length
3. Remote ID type
4. Length
5. MAC address: The Switch's system MAC address.

Figure 8- 42. Circuit ID and Remote ID Sub-option Format

DHCP/BOOTP Relay Interface Settings

The **DHCP/ BOOTP Relay Interface Settings** allow the user to set up a server, by IP address, for relaying DHCP/ BOOTP information to the Switch. The user may enter a previously configured IP interface on the Switch that will be connected directly to the DHCP/BOOTP server using the following window. Properly configured settings will be displayed in the **BOOTP Relay Table** at the bottom of the following window, once the user clicks the **Add** button under the **Apply** heading. The user may add up to four server IPs per IP interface on the Switch. Entries may be deleted by clicking it's corresponding . To enable and configure **DHCP/BOOTP Relay Global Settings** on the Switch, click **L3 Features > DHCP/BOOTP Relay > DHCP/BOOTP Relay Interface Settings**:

DHCP/BOOTP Relay Interface Settings		
Interface	Server IP	Apply
<input type="text"/>	<input type="text" value="0.0.0.0"/>	<input type="button" value="Add"/>

DHCP/BOOTP Relay Interface Table				
Interface	Server 1	Server 2	Server 3	Server 4

Figure 8- 43. DHCP/BOOTP Relay Interface Settings and DHCP/BOOTP Relay Interface Table window

The following parameters may be configured or viewed.

Parameter	Description
Interface	The IP interface on the Switch that will be connected directly to the Server.
Server IP	Enter the IP address of the DHCP/BOOTP server. Up to four server IPs can be configured per IP Interface

DNS Relay

Computer users usually prefer to use text names for computers for which they may want to open a connection. Computers themselves, require 32 bit IP addresses. Somewhere, a database of network devices' text names and their corresponding IP addresses must be maintained.

The Domain Name System (DNS) is used to map names to IP addresses throughout the Internet and has been adapted for use within intranets.

For two DNS servers to communicate across different subnets, the **DNS Relay** of the Switch must be used. The DNS servers are identified by IP addresses.

Mapping Domain Names to Addresses

Name-to-address translation is performed by a program called a Name server. The client program is called a Name resolver. A Name resolver may need to contact several Name servers to translate a name to an address.

The Domain Name System (DNS) servers are organized in a somewhat hierarchical fashion. A single server often holds names for a single network, which is connected to a root DNS server - usually maintained by an ISP.

Domain Name Resolution

The domain name system can be used by contacting the name servers one at a time, or by asking the domain name system to do the complete name translation. The client makes a query containing the name, the type of answer required, and a code specifying whether the domain name system should do the entire name translation, or simply return the address of the next DNS server if the server receiving the query cannot resolve the name.

When a DNS server receives a query, it checks to see if the name is in its sub domain. If it is, the server translates the name and appends the answer to the query, and sends it back to the client. If the DNS server cannot translate the name, it determines what type of name resolution the client requested. A complete translation is called recursive resolution and requires the server to contact other DNS servers until the name is resolved. Iterative resolution specifies that if the DNS server cannot supply an answer, it returns the address of the next DNS server the client should contact.

Each client must be able to contact at least one DNS server, and each DNS server must be able to contact at least one root server.

The address of the machine that supplies domain name service is often supplied by a DHCP or BOOTP server, or can be entered manually and configured into the operating system at startup.

DNS Relay Global Settings

To configure the DNS function on the Switch, click **L3 Features > DNS Relay > DNS Relay Global Settings**, which will open the **DNS Relay Global Settings** window, as seen below:

DNS Relay Global Settings	
DNS State	Disabled ▾
Primary Name Server	0.0.0.0
Secondary Name Server	0.0.0.0
DNSR Cache State	Disabled ▾
DNSR Static Table State	Disabled ▾
Apply	

Figure 8- 44. DNS Relay Global Settings window

The following fields can be set:

Parameter	Description
DNS State	This field can be toggled between <i>Disabled</i> and <i>Enabled</i> using the pull-down menu, and is used to enable or disable the DNS Relay service on the Switch.
Primary Name Server	Allows the entry of the IP address of a primary domain name server (DNS).

Secondary Name Server	Allows the entry of the IP address of a secondary domain name server (DNS).
DNSR Cache Status	This can be toggled between <i>Disabled</i> and <i>Enabled</i> . This determines if a DNS cache will be enabled on the Switch.
DNSR Static Table State	This field can be toggled using the pull-down menu between <i>Disabled</i> and <i>Enabled</i> . This determines if the static DNS table will be used or not.

Click **Apply** to implement changes made.

DNS Relay Static Settings

To view the **DNS Relay Static Settings**, click **L3 Features > DNS Relay > DNS Relay Static Settings**, which will open the **DNS Relay Static Settings** window, as seen below:

Figure 8- 45. DNS Relay Static Settings

To add an entry into the **DNS Relay Static Table**, simply enter a **Domain Name** with its corresponding IP address and click **Add** under the **Apply** heading. A successful entry will be presented in the table below, as shown in the example above. To erase an entry from the table, click its corresponding under the Delete heading.

VRRP

VRRP or *Virtual Routing Redundancy Protocol* is a function on the Switch that dynamically assigns responsibility for a virtual router to one of the VRRP routers on a LAN. The VRRP router that controls the IP address associated with a virtual router is called the Master, and will forward packets sent to this IP address. This will allow any Virtual Router IP address on the LAN to be used as the default first hop router by end hosts. Utilizing VRRP, the administrator can achieve a higher available default path cost without needing to configure every end host for dynamic routing or routing discovery protocols.

Statically configured default routes on the LAN are prone to a single point of failure. VRRP is designed to eliminate these failures by setting an election protocol that will assign a responsibility for a virtual router to one of the VRRP routers on the LAN. When a virtual router fails, the election protocol will select a virtual router with the highest priority to be the Master router on the LAN. This retains the link and the connection is kept alive, regardless of the point of failure.

To configure VRRP for virtual routers on the Switch, an IP interface must be present on the system and it must be a part of a VLAN. VRRP IP interfaces may be assigned to every VLAN, and therefore IP interface, on the Switch. VRRP routers within the same VRRP group must be consistent in configuration settings for this protocol to function optimally.

VRRP Global Settings

To enable VRRP globally on the Switch, click **L3 Features > VRRP > VRRP Global Settings**:



Figure 8- 46. VRRP Global Settings window

The following fields can be set:

Parameter	Description
VRRP State	Use the pull-down menu to enable or disable VRRP globally on the Switch. The default is <i>Disabled</i> .
Non-Owner Response PING	Enabling this parameter will allow the virtual IP address to be pinged from other host end nodes to verify connectivity. This will only enable the ping connectivity check function. This command is <i>Disabled</i> by default.

Click **Apply** to implement changes made.

VRRP Virtual Router Settings

The following window will allow the user to view the parameters for the VRRP function on the Switch. To view this window, click **L3 Features > VRRP > VRRP Virtual Router Settings**:

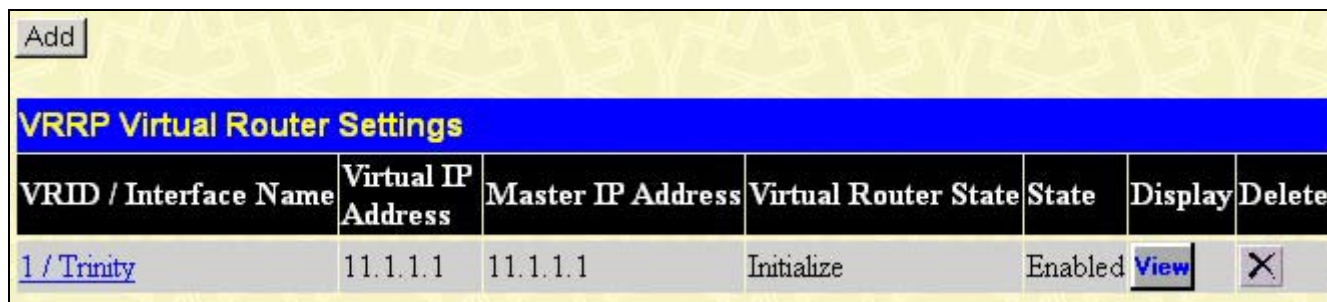



Figure 8- 47. VRRP Virtual Router Settings window

The following fields are displayed in the window above:

Parameter	Description
VRID / Interface Name	<i>VRID</i> - Displays the virtual router ID set by the user. This will uniquely identify the VRRP Interface on the network. <i>Interface Name</i> - An IP interface name that has been enabled for VRRP. This entry must have been previously set in the IP Interfaces table.
Virtual IP Address	The IP address of the Virtual router configured on the Switch.
Master IP Address	Displays the IP address of the Master router for the VRRP function.
Virtual Router State	Displays the current state of the Virtual Router on the Switch. Possible states include <i>Initialize</i> , <i>Master</i> and <i>Backup</i> .
State	Displays the VRRP state of the corresponding VRRP entry.
Display	Click the  button to display the settings for this particular VRRP entry.
Delete	Click the  to delete this VRRP entry.

Click the **Add** button to display the following window to configure a VRRP interface.

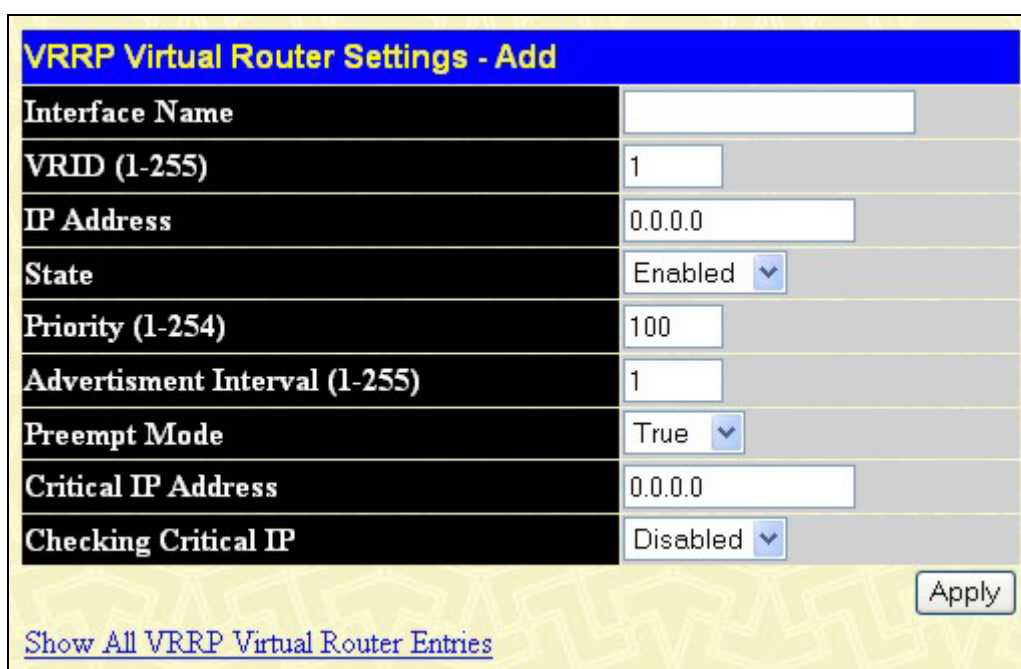

Figure 8- 48. VRRP Virtual Router Settings - Add

Or, the user may click the hyperlinked **Interface Name** to view the same window:

The following parameters may be set to configure an existing or new VRRP interface.

Parameter	Description
Interface Name	Enter the name of a previously configured IP interface for which to create a VRRP entry. This IP interface must be assigned to a VLAN on the Switch.
VRID (1-255)	Enter a value between 1 and 255 to uniquely identify this VRRP group on the Switch. All routers participating in this group must be assigned the same VRID value. This value MUST be different from other VRRP groups set on the Switch.
IP Address	Enter the IP address that will be assigned to the VRRP router. This IP address is also the default gateway that will be statically assigned to end hosts and must be set for all routers that participate in this group.

State	Used to enable (Up) and disable (Down) the VRRP IP interface on the Switch.
Priority (1-254)	Enter a value between 1 and 254 to indicate the router priority. The VRRP Priority value may determine if a higher priority VRRP router overrides a lower priority VRRP router. A higher priority will increase the probability that this router will become the Master router of the group. A lower priority will increase the probability that this router will become the backup router. VRRP routers that are assigned the same priority value will elect the highest physical IP address as the Master router. The default value is 100. (The value of 255 is reserved for the router that owns the IP address associated with the virtual router and is therefore set automatically.)
Advertisement Interval (1-255)	Enter a time interval value, in seconds, for sending VRRP message packets. This value must be consistent with all participating routers. The default is 1 second.
Preempt Mode	This entry will determine the behavior of backup routers within the VRRP group by controlling whether a higher priority backup router will preempt a lower priority Master router. A <i>True</i> entry, along with having the backup router's priority set higher than the masters priority, will set the backup router as the Master router. A <i>False</i> entry will disable the backup router from becoming the Master router. This setting must be consistent with all routers participating within the same VRRP group. The default setting is <i>True</i> .
Critical IP Address	Enter the IP address of the physical device that will provide the most direct route to the Internet or other critical network connections from this virtual router. This must be a real IP address of a real device on the network. If the connection from the virtual router to this IP address fails, the virtual router will automatically disabled. A new Master will be elected from the backup routers participating in the VRRP group. Different critical IP addresses may be assigned to different routers participating in the VRRP group, and can therefore define multiple routes to the Internet or other critical network connections.
Checking Critical IP	Use the pull-down menu to enable or disable the Critical IP address entered above.

Click **Apply** to implement changes made.

To view the settings for a particular VRRP setting, click the corresponding [View](#) in the **VRRP Interface Table** of the entry, which will display the following:

VRRP Virtual Router Settings - Display	
Interface Name	Trinity
Authentication type	No Authentication
VRID	1
Virtual IP Address	11.1.1.1
Virtual MAC Address	00:00:5e:00:01:01
Virtual Router State	Initialize
State	Enabled
Priority	255
Master IP Address	11.1.1.1
Critical IP Address	0.0.0.0
Checking Critical IP	Disabled
Advertisement Interval	1
Preempt Mode	True
Virtual Router Up Time	0

[Show All VRRP Virtual Router Entries](#)

Figure 8- 49. VRRP Virtual Router Settings - Display window

This window displays the following information:

Parameter	Description
Interface Name	An IP interface name that has been enabled for VRRP. This entry must have been previously set in the IP Interface Settings table.
Authentication type	Displays the type of authentication used to compare VRRP packets received by a virtual router. Possible authentication types include: <ul style="list-style-type: none"> • <i>No authentication</i> - No authentication has been selected to compare VRRP packets received by a virtual router. • <i>Simple Text Password</i> - A <i>Simple</i> password has been selected to compare VRRP packets received by a virtual router, for authentication. • <i>IP Authentication Header</i> - An MD5 message digest algorithm has been selected to compare VRRP packets received by a virtual router, for authentication.
VRID	Displays the virtual router ID set by the user. This will uniquely identify the VRRP Interface on the network.
Virtual IP Address	The IP address of the Virtual router configured on the Switch.
Virtual MAC Address	The MAC address of the device that holds the Virtual router.
Virtual Router State	Displays the current status of the virtual router. Possible states include <i>Initialize</i> , <i>Master</i> and <i>Backup</i> .
Admin. State	Displays the current state of the router. <i>Up</i> will be displayed if the virtual router is enabled and <i>Down</i> , if the virtual router is disabled.
Priority	Displays the priority of the virtual router. A higher priority will increase the probability that this router will become the Master router of the group. A lower priority will increase the probability that this router will become the backup router. The lower the number, the higher the priority.
Master IP Address	Displays the IP address of the Master router for the VRRP function.
Critical IP Address	Displays the critical IP address of the VRRP function. This address will judge if a virtual router is qualified to be a master router.
Checking Critical IP	Displays the status of the Critical IP address. May be enabled or disabled.
Advertisement Interval	Displays the time interval, in seconds, which VRRP messages are sent out to the network.
Preempt Mode	Displays the mode for determining the behavior of backup routers set on this VRRP interface. <i>True</i> will denote that this will be the backup router, if the routers priority is set higher than the master router. <i>False</i> will disable the backup router from becoming the master router.
Virtual Router Up Time	Displays the time, in minutes, since the virtual router has been initialized

VRRP Authentication Settings

The **VRRP Authentication Settings** window is used to set the authentication for each Interface configured for VRRP. This authentication is used to identify incoming message packets received by a router. If the authentication is not consistent with incoming packets, they will be discarded. The **Authentication Type** must be consistent with all routers participating within the VRRP group.

To view the following window, click **L3 Features > VRRP > VRRP Authentication Settings**.

VRRP Authentication Settings	
Interface Name	Authentication Type
System	No Authentication
Trinity	No Authentication

Figure 8- 50. VRRP Authentication Settings window

To configure the authentication for a pre-created interface, click its hyperlinked name, revealing the following window to configure:

VRRP Authentication Settings - Edit	
Interface Name	Trinity
Authentication Type	None <input type="button" value="v"/>
Authentication Data	<input type="text"/>
<input type="button" value="Apply"/>	
Show All VRRP Interface Entries	

Figure 8- 51. VRRP Authentication Settings – Edit window

The following parameters may be viewed or configured:

Parameter	Description
Interface Name	The name of a previously created IP interface for which to configure the VRRP authentication.
Authentication Type	Specifies the type of authentication used. The Authentication Type must be consistent with all routers participating within the VRRP group. The choices are: <ul style="list-style-type: none"> <i>None</i> - Selecting this parameter indicates that VRRP protocol exchanges will not be authenticated. <i>Simple</i> - Selecting this parameter will require the user to set a simple password in the Auth. Data field for comparing VRRP message packets received by a router. If the two passwords are not exactly the same, the packet will be dropped. <i>IP</i> - Selecting this parameter will require the user to set a MD5 message digest for authentication in comparing VRRP messages received by the router. If the two values are inconsistent, the packet will be dropped.
Authentication Data	This field is only valid if the user selects <i>Simple</i> or <i>IP</i> in the Authentication Type field. <ul style="list-style-type: none"> <i>Simple</i> will require the user to enter an alphanumeric string of no more than eight characters to identify VRRP packets received by a router. <i>IP</i> will require the user to enter a MD5 message digest for authentication in comparing VRRP messages received by the router. <p>This entry must be consistent with all routers participating in the same IP interface.</p>

Click **Apply** to implement changes made.

IP Multicast Routing Protocol

The functions supporting IP multicasting are added under the **IP Multicast Routing Protocol** folder, from the **L3 Features** folder. **IGMP**, **DVMRP**, and **PIM-DM** can be enabled or disabled on the Switch without changing the individual protocol's configuration by using the **DES-3800 Web Management Tool**.

IGMP

Computers and network devices that want to receive multicast transmissions need to inform nearby routers that they will become members of a multicast group. The **Internet Group Management Protocol (IGMP)** is used to communicate this information. IGMP is also used to periodically check the multicast group for members that are no longer active.

In the case where there is more than one multicast router on a subnetwork, one router is elected as the 'querier'. This router then keeps track of the membership of the multicast groups that have active members. The information received from IGMP is then used to determine if multicast packets should be forwarded to a given subnetwork or not. The router can check, using IGMP, to see if there is at least one member of a multicast group on a given subnetwork. If there are no members on a subnetwork, packets will not be forwarded to that subnetwork.

IGMP Versions 1 and 2

Multicast groups allow members to join or leave at any time. IGMP provides the method for members and multicast routers to communicate when joining or leaving a multicast group.

IGMP version 1 is defined in RFC 1112. It has a fixed packet size and no optional data.

The format of an IGMP packet is shown below:

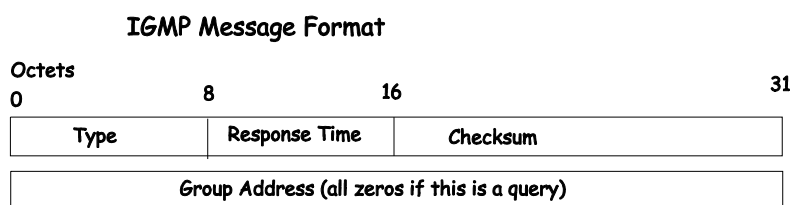

Figure 8- 52. IGMP Message Format

The IGMP Type codes are shown below:

Type	Meaning
0x11	Membership Query (if Group Address is 0.0.0.0)
0x11	Specific Group Membership Query (if Group Address is Present)
0x16	Membership Report (version 2)
0x17	Leave a Group (version 2)
0x12	Membership Report (version 1)

Table 8- 4. IGMP Type Codes

IGMP packets enable multicast routers to keep track of the membership of multicast groups, on their respective subnetworks. The following outlines what is communicated between a multicast router and a multicast group member using IGMP.

A host sends an IGMP "report" to join a group

A host will never send a report when it wants to leave a group (for version 1).

A host will send a "leave" report when it wants to leave a group (for version 2).

Multicast routers send IGMP queries (to the all-hosts group address: 224.0.0.1) periodically to see whether any group members exist on their subnetworks. If there is no response from a particular group, the router assumes that there are no group members on the network.

The Time-to-Live (TTL) field of query messages is set to 1 so that the queries will not be forwarded to other subnetworks.

IGMP version 2 introduces some enhancements such as a method to elect a multicast querier for each LAN, an explicit leave message, and query messages that are specific to a given group.

The states a computer will go through to join or to leave a multicast group are shown below:

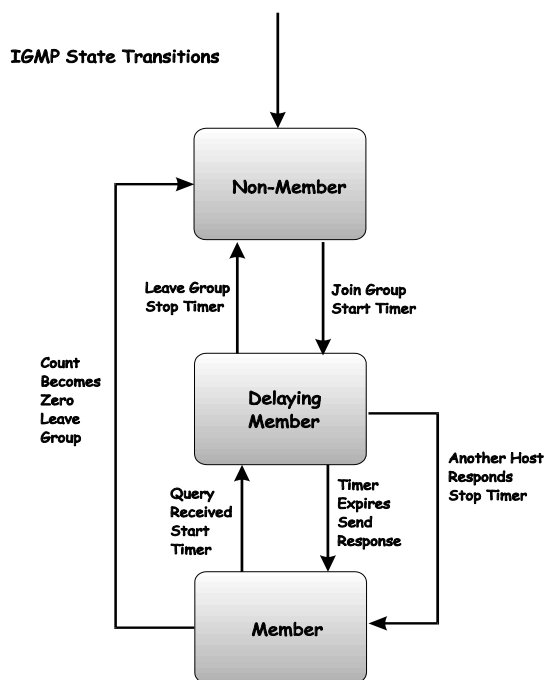

Figure 8- 53. IGMP State Transitions

IGMP Version 3

The current release of the xStack DES-3800 switch series now implements IGMPv3. Improvements of IGMPv3 over version 2 include:

- The introduction of the *SSM* or *Source Specific Multicast*. In previous versions of IGMP, the host would receive all packets sent to the multicast group. Now, a host will receive packets only from a specific source or sources. This is done through the implementation of *include* and *exclude* filters used to accept or deny traffic from these specific sources.
- In IGMP v2, Membership reports could contain only one multicast group whereas in v3, these reports can contain multiple multicast groups and multiple sources within the multicast group.
- Leaving a multicast group could only be accomplished using a specific leave message in v2. In v3, leaving a multicast group is done through a Membership report which includes a block message in the group report packet.
- For version 2, the host could respond to a group query but in version 3, the host is now capable to answer queries specific to the group and the source.

IGMP v3 is backwards compatible with other versions of IGMP.

The IGMPv3 Type supported codes are shown below:

Type	Meaning
0x11	Membership Query
0x12	Version 1 Membership Report
0x16	Version 2 Membership Report
0x17	Version 2 Leave Group
0x22	IGMPv3 Membership Report

Timers

As previously mentioned, IGMPv3 incorporates filters to include or exclude sources. These filters are kept updated using timers. IGMPv3 utilizes two types of timers, one for the group and one for the source. The purpose of the filter mode is to reduce the reception state of a multicast group so that all members of the multicast group are satisfied. This filter mode is dependant on membership reports and timers of the multicast group. These filters are used to maintain a list of multicast sources and groups of multicast receivers that more accurately reflect the actual sources and receiving groups at any one time on the network.

Source timers are used to keep sources present and active within a multicast group on the Switch. These source timers are refreshed if a group report packet is received by the Switch, which holds information pertaining to the active source group record part of a report packet. If the filter mode is exclude, traffic is being denied from at least one specific source, yet other hosts may be accepting traffic from the multicast group. If the group timer expires for the multicast group, the filter mode is changed to include and other hosts can receive traffic from the source. If no group report packet is received and the filter mode is include, the Switch presumes that traffic from the source is no longer wanted on the attached network and the source record list is then deleted after all source timers expire. If there is no source list record in the multicast group, the multicast group will be deleted from the Switch.

Timers are also used for IGMP version 1 and 2 members, which are a part of a multicast group when the Switch is running IGMPv3. This timer is based on a host within the multicast group that is running IGMPv1 or v2. Receiving a group report from an IGMPv1 or v2 host within the multicast group will refresh the timer and keep the v1 and/or v2 membership alive in v3.



NOTE: The length of time for all timers utilized in IGMPv3 can be determined using IGMP configurations to perform the following calculation:

$$(Query\ Interval \times Robustness\ Variable) + One\ Query\ Response\ Interval$$

IGMP Interface Settings

The Internet Group Multicasting Protocol (IGMP) can be configured on the Switch on a per-IP interface basis. To view the **IGMP Interface Table**, open the **IP Multicast Routing Protocol** folder under **L3 Features** and click **IGMP Interface Settings**. Each IP interface configured on the Switch is displayed in the below **IGMP Interface Settings** dialog box. To configure IGMP for a particular interface, click the corresponding hyperlink for that IP interface. This will open another **IGMP Interface Settings – Edit** window:

IGMP Interface Settings							
Interface Name	IP Address	Version	Query Interval	Max Response Time	Robustness Variable	Last Member Query Interval	State
System	10.53.13.52	3	125	10	2	1	Disabled
Trinity	11.1.1.1	3	125	10	2	1	Disabled

Figure 8- 54. IGMP Interface Settings window

IGMP Interface Settings - Edit	
Interface Name	Trinity
IP Address	11.1.1.1
Version	3
Query Interval (1- 31744)	125
Max Response Time (1-25)	10
Robustness Variable (1-255)	2
Last Member Query Interval (1-25)	1
State	Disabled
Apply	
Show All IGMP Interface Entries	

Figure 8- 55. IGMP Interface Settings – Edit window

This window allows the configuration of IGMP for each IP interface configured on the Switch. IGMP can be configured as Version 1, 2 or 3 by toggling the **Version** field using the pull-down menu. The length of time between queries can be varied by entering a value between 1 and 31,744 seconds in the **Query Interval** field. The maximum length of time between the receipt of a query and the sending of an IGMP response report can be varied by entering a value in the **Max Response Time** field.

The **Robustness Variable** field allows IGMP to be ‘tuned’ for sub-networks that are expected to lose many packets. A high value (max. 255) for the robustness variable will help compensate for ‘lossy’ sub-networks. A low value (min. 2) should be used for less ‘lossy’ sub-networks.

The following fields can be set:

Parameter	Description
Interface Name	Displays the name of the IP interface that is to be configured for IGMP. This must be a previously configured IP interface.
IP Address	Displays the IP address corresponding to the IP interface name above.
Version	Enter the IGMP version (1, 2 or 3) that will be used to interpret IGMP queries on the interface.
Query Interval	Allows the entry of a value between 1 and 31744 seconds, with a default of 125 seconds. This specifies the length of time between sending IGMP queries.
Max Response Time	Sets the maximum amount of time allowed before sending an IGMP response report. A value between 1 and 25 seconds can be entered, with a default of 10 seconds.
Robustness Variable	A tuning variable to allow for subnetworks that are expected to lose a large number of packets. A value between 1 and 255 can be entered, with larger values being specified for subnetworks that are expected to lose larger numbers of packets.
Last Member Query Interval	Specifies the maximum amount of time between group-specific query messages, including those sent in response to leave group messages. A value between 1 and 25. The default is 1 second.
State	This field can be toggled between <i>Enabled</i> and <i>Disabled</i> and enables or disables IGMP for the IP interface. The default is <i>Disabled</i> .

Click **Apply** to implement changes made.

DVMRP Interface Configuration

The Distance Vector Multicast Routing Protocol (**DVMRP**) is a hop-based method of building multicast delivery trees from multicast sources to all nodes of a network. Because the delivery trees are ‘pruned’ and ‘shortest path’, DVMRP is relatively efficient. Because multicast group membership information is forwarded by a distance-vector algorithm, propagation is slow. DVMRP is optimized for high delay (high latency) relatively low bandwidth networks, and can be considered as a ‘best-effort’ multicasting protocol.

DVMRP resembles the Routing Information Protocol (RIP), but is extended for multicast delivery. DVMRP builds a routing table to calculate ‘shortest paths’ back to the source of a multicast message, but defines a ‘route cost’ (similar to the hop count in RIP) as a relative number that represents the real cost of using this route in the construction of a multicast delivery tree to be ‘pruned’ - once the delivery tree has been established.

When a sender initiates a multicast, DVMRP initially assumes that all users on the network will want to receive the multicast message. When an adjacent router receives the message, it checks its unicast routing table to determine the interface that gives the shortest path (lowest cost) back to the source. If the multicast was received over the shortest path, then the adjacent router enters the information into its tables and forwards the message. If the message is not received on the shortest path back to the source, the message is dropped.

Route cost is a relative number that is used by DVMRP to calculate which branches of a multicast delivery tree should be ‘pruned’. The ‘cost’ is relative to other costs assigned to other DVMRP routes throughout the network.

The higher the route cost, the lower the probability that the current route will be chosen to be an active branch of the multicast delivery tree (not ‘pruned’) - if there is an alternative route.

DVMRP Global Settings

To enable DVMRP globally on the Switch, click **L3 Features > IP Multicast Routing Protocol > DVMRP Global Settings**. This will give the user access to the following screen:



Figure 8- 56. DVMRP Global Settings window

Use the pull down menu, choose *Enabled*, and click **Apply** to implement the DVMRP function on the Switch.

DVMRP Interface Settings

To view the **DVMRP Interface Table**, click **L3 Features > IP Multicast Routing Protocol > DVMRP Interface Settings**. This menu allows the **Distance-Vector Multicast Routing Protocol (DVMRP)** to be configured for each IP interface defined on the Switch. Each IP interface configured on the Switch is displayed in the below **DVMRP Interface Configuration** dialog box. To configure DVMRP for a particular interface, click the corresponding hyperlink for that IP interface. This will open the **DVMRP Interface Settings** window:

DVMRP Interface Settings					
Interface Name	IP Address	Neighbor Timeout	Probe	Metric	State
System	10.53.13.52	35	10	1	Disabled
Trinity	11.1.1.1	35	10	1	Disabled

Figure 8- 57. DVMRP Interface Settings window

DVMRP Interface Settings - Edit	
Interface Name	Trinity
IP Address	11.1.1.1
Neighbor Timeout (1-65535 sec)	<input type="text" value="35"/>
Probe Interval (1-65535 sec)	<input type="text" value="10"/>
Metric (1-31)	<input type="text" value="1"/>
State	Disabled <input type="button" value="v"/>
<input type="button" value="Apply"/>	
Show All DVMRP Interface Entries	

Figure 8- 58. DVMRP Interface Settings - Edit window

The following fields can be set:

Parameter	Description
Interface Name	Displays the name of the IP interface for which DVMRP is to be configured. This must be a previously defined IP interface.
IP Address	Displays the IP address corresponding to the IP Interface name entered above.
Neighbor Timeout Interval (1-65535)	This field allows an entry between 1 and 65,535 seconds and defines the time period DVMRP will hold Neighbor Router reports before issuing poison route messages. The default is 35 seconds.
Probe Interval (1-65535)	This field allows an entry between 1 and 65,535 seconds and defines the interval between 'probes'. The default is 10.
Metric (1-31)	This field allows an entry between 1 and 31 and defines the route cost for the IP interface. The DVMRP route cost is a relative number that represents the real cost of using this route in the construction of a multicast delivery tree. It is similar to, but not defined as, the hop count in RIP. The default cost is 1.
State	This field can be toggled between <i>Enabled</i> and <i>Disabled</i> and enables or disables DVMRP for the IP interface. The default is <i>Disabled</i> .

Click **Apply** to implement changes made. Click [Show All DVMRP Interface Entries](#) to return to the **DVMRP Interface Settings** window.

PIM-DM Interface Configuration

The *Protocol Independent Multicast - Dense Mode* (PIM-DM) protocol should be used in networks with a low delay (low latency) and high bandwidth as PIM-DM is optimized to guarantee delivery of multicast packets, not to reduce overhead.

The PIM-DM multicast routing protocol assumes that all downstream routers want to receive multicast messages and relies upon explicit prune messages from downstream routers to remove branches from the multicast delivery tree that do not contain multicast group members.

PIM-DM has no explicit ‘join’ messages. It relies upon periodic flooding of multicast messages to all interfaces and then either waiting for a timer to expire (the **Join/Prune Interval**) or for the downstream routers to transmit explicit ‘prune’ messages indicating that there are no multicast members on their respective branches. PIM-DM then removes these branches (‘prunes’ them) from the multicast delivery tree.

Because a member of a pruned branch of a multicast delivery tree may want to join a multicast delivery group (at some point in the future), the protocol periodically removes the ‘prune’ information from its database and floods multicast messages to all interfaces on that branch. The interval for removing ‘prune’ information is the **Join/Prune Interval**.

PIM-DM Configuration

To enable PIM-DM globally on the Switch, go to **L3 Features > IP Multicast Routing Protocol > PIM-DM > PIM-DM Global Settings**. This will give the user access to the following screen:



Figure 8- 59. PIM DM Global Setting window

Use the pull down menu, choose *Enabled*, and click **Apply** to set the PIM-DM function on the Switch.

PIM-DM Interface Configuration

To view the **PIM-DM Table**, click **L3 Features > IP Multicast Routing Protocol > PIM-DM > PIM-DM Interface Settings**. This window allows the **PIM-DM** to be configured for each IP interface defined on the Switch. Each IP interface configured on the Switch is displayed in the below **PIM-DM Interface Settings** dialog box. To configure PIM-DM for a particular interface, click the corresponding hyperlink for that IP interface. This will open the **PIM-DM Interface Settings** window:

PIM-DM Interface Settings				
Interface Name	IP Address	Hello Interval	Join/Prune Interval	State
System	10.53.13.52	30	60	Disabled
Trinity	11.1.1.1	30	60	Disabled

Figure 8- 60. PIM-DM Interface Settings window

To view the configuration window for a specific entry, click its hyperlinked name, revealing the following window.

Figure 8- 61. PIM-DM Interface Settings - Edit window

The following fields can be set or viewed:

Parameter	Description
Interface Name	Allows the entry of the name of the IP interface for which PIM-DM is to be configured. This must be a previously defined IP interface.
IP Address	Displays the IP address for the IP interface named above.
Hello Interval (1-18724)	This field allows an entry of between 1 and 18724 seconds and determines the interval between sending Hello packets to other routers on the network. The default is 30 seconds.
Join/Prune Interval (1-18724)	This field allows an entry of between 1 and 18724 seconds. This interval also determines the time interval the router uses to automatically remove prune information from a branch of a multicast delivery tree and begin to flood multicast messages to all branches of that delivery tree. These two actions are equivalent. The default is 60 seconds.
State	This field can be toggled between <i>Enabled</i> and <i>Disabled</i> using the pull-down menu, and is used to enable or disable PIM-DM for the IP interface. The default is <i>Disabled</i> .

Click **Apply** to implement changes made. Click [Show All PIM-DM Interface Entries](#) to return to the **PIM-DM Interface Table**.

Section 9

QoS

Bandwidth Control

QoS Scheduling Mechanism

QoS Output Scheduling

802.1P Default Priority

802.1P User Priority

WRED Settings

The DES-3800 Series supports 802.1p priority queuing Quality of Service. The following section discusses the implementation of QoS (Quality of Service) and benefits of using 802.1p priority queuing.

Advantages of QoS

QoS is an implementation of the IEEE 802.1p standard that allows network administrators a method of reserving bandwidth for important functions that require a large bandwidth or have a high priority, such as VoIP (voice-over Internet Protocol), web browsing applications, file server applications or video conferencing. Not only can a larger bandwidth be created, but other less critical traffic can be limited, so excessive bandwidth can be saved. The Switch has separate hardware queues on every physical port to which packets from various applications can be mapped to, and, in turn prioritized. View the following map to see how the DES-3800 Series implements 802.1P priority queuing.

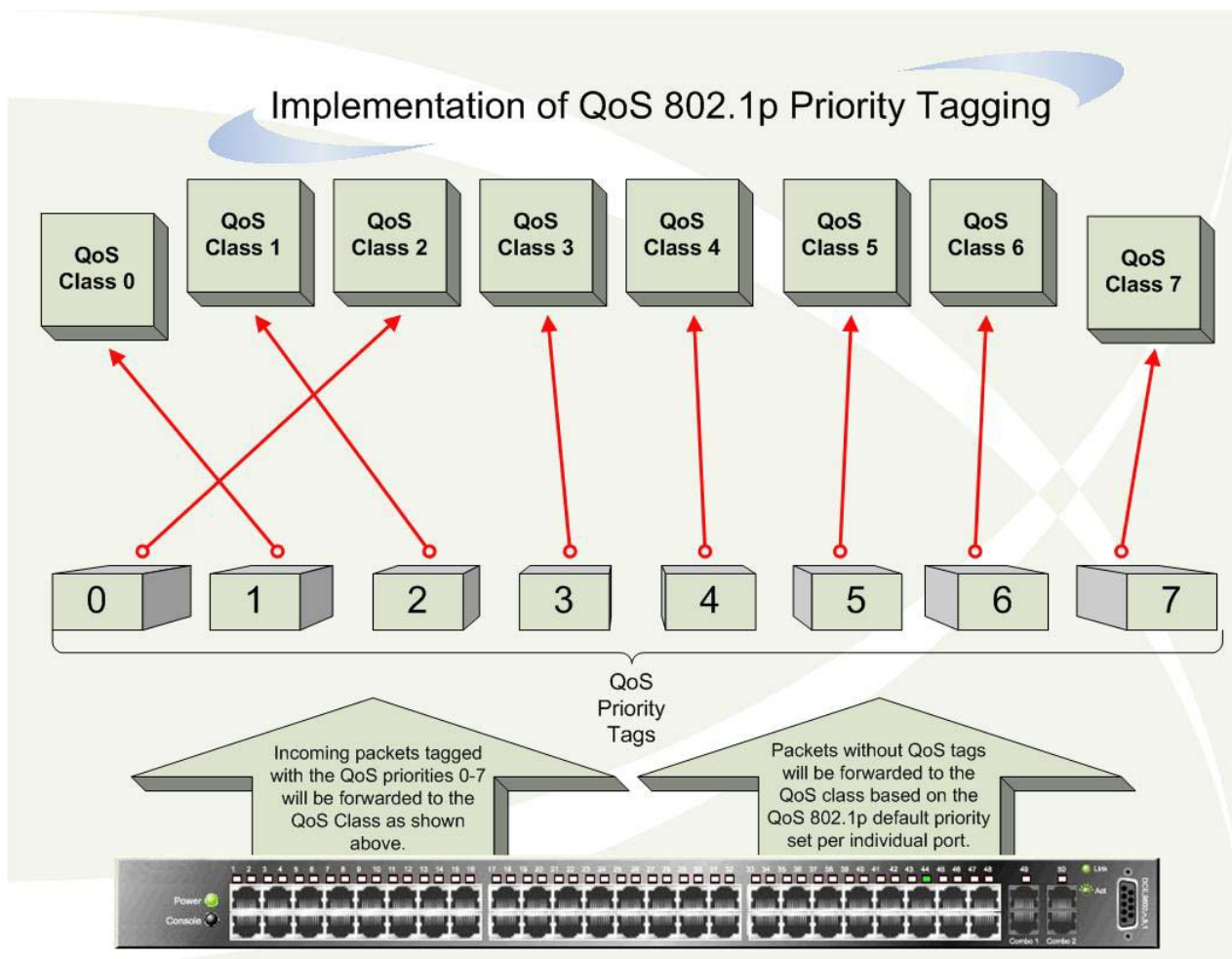

Figure 9- 1. Mapping QoS on the Switch

The picture above shows the default priority setting for the Switch. Class-7 has the highest priority of the eight priority queues on the Switch. In order to implement QoS, the user is required to instruct the Switch to examine the header of a packet to see if it has the proper identifying tag tagged. Then the user may forward these tagged packets to designated queues on the Switch where they will be emptied, based on priority.

For example, lets say a user wishes to have a video conference between two remotely set computers. The administrator can add priority tags to the video packets being sent out, utilizing the Access Profile commands. Then, on the receiving end, the administrator instructs the Switch to examine packets for this tag, acquires the tagged packets and maps them to a class queue on the Switch. Then in turn, the administrator will set a priority for this queue so that will be emptied before any other packet is forwarded. This results in the end user receiving all packets sent as quickly as possible, thus prioritizing the queue and allowing for an uninterrupted stream of packets, which optimizes the use of bandwidth available for the video conference.

Understanding QoS

The Switch has eight priority queues. These priority queues are labeled as 7, the high queue to 0, the lowest queue. The eight priority tags, specified in IEEE 802.1p are mapped to the Switch's priority tags as follows:

- Priority 0 is assigned to the Switch's Q2 queue.
- Priority 1 is assigned to the Switch's Q0 queue.
- Priority 2 is assigned to the Switch's Q1 queue.
- Priority 3 is assigned to the Switch's Q3 queue.
- Priority 4 is assigned to the Switch's Q4 queue.
- Priority 5 is assigned to the Switch's Q5 queue.
- Priority 6 is assigned to the Switch's Q6 queue.
- Priority 7 is assigned to the Switch's Q7 queue.

For strict priority-based scheduling, any packets residing in the higher priority queues are transmitted first. Multiple strict priority queues empty based on their priority tags. Only when these queues are empty, are packets of lower priority transmitted.

For weighted round robin queuing, the number of packets sent from each priority queue depends upon the assigned weight. For a configuration of 8 CoS queues, A~H with their respective weight value: 8~1, the packets are sent in the following sequence: A1, B1, C1, D1, E1, F1, G1, H1, A2, B2, C2, D2, E2, F2, G2, A3, B3, C3, D3, E3, F3, A4, B4, C4, D4, E4, A5, B5, C5, D5, A6, B6, C6, A7, B7, A8, A1, B1, C1, D1, E1, F1, G1, H1.

For weighted round robin queuing, if each CoS queue has the same weight value, then each CoS queue has an equal opportunity to send packets just like round robin queuing.

For weighted round-robin queuing, if the weight for a CoS is set to 0, then it will continue processing the packets from this CoS until there are no more packets for this CoS. The other CoS queues that have been given a nonzero value, and depending upon the weight, will follow a common weighted round-robin scheme.

Remember that the DES-3800 Series has eight priority queues (and eight Classes of Service) for each port on the Switch.

Port Bandwidth

The bandwidth control settings are used to place a ceiling on the transmitting and receiving data rates for any selected port. In the **QoS** folder, click **Bandwidth Control**, to view the window shown to the left.

Bandwidth Settings					
From	To	Type	No Limit	Rate (64-1000000) (Kbit/sec)	Apply
Port 1 ▾	Port 1 ▾	Both ▾	Disabled ▾	1	Apply

Port Bandwidth Table		
Port	RX Rate (Kbit/sec)	TX Rate (Kbit/sec)
1	No Limit	No Limit
2	No Limit	No Limit
3	No Limit	No Limit
4	No Limit	No Limit
5	No Limit	No Limit
6	No Limit	No Limit
7	No Limit	No Limit
8	No Limit	No Limit
9	No Limit	No Limit
10	No Limit	No Limit
11	No Limit	No Limit
12	No Limit	No Limit
13	No Limit	No Limit
14	No Limit	No Limit
15	No Limit	No Limit
16	No Limit	No Limit
17	No Limit	No Limit
18	No Limit	No Limit
19	No Limit	No Limit
20	No Limit	No Limit
21	No Limit	No Limit
22	No Limit	No Limit
23	No Limit	No Limit
24	No Limit	No Limit
25	No Limit	No Limit
26	No Limit	No Limit
27	No Limit	No Limit
28	No Limit	No Limit

Figure 9- 2. Bandwidth Settings window

The following parameters can be set or are displayed:

Parameter	Description
From/To	A consecutive group of ports may be configured starting with the selected port.
Type	This drop-down menu allows you to select between <i>RX</i> (receive), <i>TX</i> (transmit), and <i>Both</i> . This setting will determine whether the bandwidth ceiling is applied to receiving, transmitting, or both receiving and transmitting packets.
No Limit	This drop-down menu allows you to specify that the selected port will have no bandwidth limit. <i>Enabled</i> disables the limit.
Rate	This field allows you to enter the data rate, in Kbits per second, that will be the limit for the selected port. The value must be a multiple of 64, between 64 and 1000000.

Click **Apply** to set the bandwidth control for the selected ports. Results of configured Bandwidth Settings will be displayed in the **Port Bandwidth Table**.

QoS Scheduling Mechanism

Changing the output scheduling used for the hardware queues in the Switch can customize QoS. As with any changes to QoS implementation, careful consideration should be given to how network traffic in lower priority queues is affected. Changes in scheduling may result in unacceptable levels of packet loss or significant transmission delay. If you choose to customize this setting, it is important to monitor network performance, especially during peak demand, as bottlenecks can quickly develop if the QoS settings are not suitable. In the **QoS** folder, click **QoS Scheduling Mechanism**, to view the window shown below.

QoS Scheduling Mechanism	
Scheduling Mechanism	Strict
Apply	
QoS Scheduling Mechanism Table	
Class ID	Mechanism
Class-0	Strict
Class-1	Strict
Class-2	Strict
Class-3	Strict
Class-4	Strict
Class-5	Strict
Class-6	Strict
Class-7	Strict

Figure 9- 3. QoS Output Scheduling window

The **Scheduling Mechanism** has the following parameters.

Parameter	Description
Strict	The highest class of service is the first to process traffic. That is, the highest class of service will finish before other queues empty.
Weight Robin	Use the weighted round-robin (<i>WRR</i>) algorithm to handle packets in an even distribution in priority classes of service.

Click **Apply** to implement changes made.



NOTE: The settings you assign to the queues, numbers 0-7, represent the IEEE 802.1p priority tag number. Do not confuse these settings with port numbers.

QoS Output Scheduling

QoS can be customized by changing the output scheduling used for the hardware classes of service in the Switch. As with any changes to QoS implementation, careful consideration should be given to how network traffic in lower priority classes of service is affected. Changes in scheduling may result in unacceptable levels of packet loss or significant transmission delay. If choosing to customize this setting, it is important to monitor network performance, especially during peak demand, as bottlenecks can quickly develop if the QoS settings are not suitable. In the **QoS** folder click **QoS Output Scheduling**, to view the screen shown below.

QoS Output Scheduling	
	Max. Packets
Class-0	1
Class-1	2
Class-2	3
Class-3	4
Class-4	5
Class-5	6
Class-6	7
Class-7	8

Apply

Figure 9- 4. QoS Output Scheduling window

The following values may be assigned to the QoS classes to set the scheduling.

Parameter	Description
Max. Packets	Specifies the maximum number of packets the above specified hardware priority class of service will be allowed to transmit before allowing the next lowest priority queue to transmit its packets. A value between 0 and 15 can be specified.

Click **Apply** to implement changes made.

802.1p Default Priority

The Switch allows the assignment of a default 802.1p priority to each port on the Switch. In the **QoS** folder, click **802.1p Default Priority**, to view the window shown below.

802.1p Default Priority			
From	To	Priority(0--7)	Apply
Port 1 <input type="button" value="v"/>	Port 1 <input type="button" value="v"/>	<input type="text" value="0"/>	<input type="button" value="Apply"/>

802.1p Default Priority	
Port	Priority
1	0
2	0
3	0
4	0
5	0
6	0
7	0
8	0
9	0
10	0
11	0
12	0
13	0
14	0
15	0
16	0
17	0
18	0
19	0
20	0
21	0
22	0
23	0
24	0
25	0
26	0
27	0
28	0

Figure 9- 5. 802.1p Default Priority Settings window

This window allows you to assign a default 802.1p priority to any given port on the Switch. The priority queues are numbered from 0, the lowest priority, to 7, the highest priority. Click **Apply** to implement your settings.

802.1p User Priority

The DES-3800 Series allows the assignment of a user priority to each of the 802.1p priorities. In the **QoS** folder, click **802.1p User Priority**, to view the screen shown below.

802.1p User Priority	
Priority-0	Class-2
Priority-1	Class-0
Priority-2	Class-1
Priority-3	Class-3
Priority-4	Class-4
Priority-5	Class-5
Priority-6	Class-6
Priority-7	Class-7

Apply

Figure 9- 6. QoS Class of Traffic window

Once you have assigned a priority to the port groups on the Switch, you can then assign this Class to each of the 8 levels of 802.1p priorities. Click **Apply** to set your changes.

WRED Settings

WRED or Weighted Random Early Discard is another implementation for QoS that will help the overall throughput for your QoS queues. Based on the egress queue of the QoS function set on the Switch, this method will analyze these packets and their QoS queue to determine if there will be an overflow of packets entering the QoS queues and consequentially, minimize the packet flow into these queues by dropping random packets. WRED employs two methods of avoiding congestion within the QoS queue.

1. Every QoS queue has a minimum and a maximum level for acceptance of packets. Once the maximum threshold has been reached for this queue, the switch will begin discarding all ingress packets, this minimizing the allotted bandwidth for QoS. When below the minimum threshold, the switch will accept all ingress packets.
2. When the ingress packets are somewhere between the maximum and minimum queue, the Switch will use a slope probability function to determine a random method of dropping packets based on the fill percentage of the QoS queue. If queues are closer to being full, the Switch will increase the discarding of random packets to even out the flow to the queues and avoid overflows to higher priority queues.

WRED State: Disable Apply

WRED Setting

Port List: From: Port 1 To: Port 1

Class ID: all

Cfg. Parameter: All Parameters

Drop Start: 50 % (0-100)

Drop Slope: 45 degrees(0-90)

Average Time: 100 microseconds(1-32768)

Apply

Figure 9- 7. WRED Settings window

To configure WRED settings for the Switch, configure the following fields and click **Apply**. Note that WRED State may be separately globally enabled and disabled and has its own **Apply** button for this reason.

Parameter	Description
WRED State	Allows the user to globally enable and disable the WRED function on this switch without altering previously made configurations. Use the pull-down menu and click the Apply button, located directly adjacent to the WRED State configuration field.
Port List	Use the pull-down menus to select a port or range of ports to be configured for WRED.
Class ID	Select the CoS ID, from 0-7, to configure for the WRED parameters. Selecting <i>all</i> will set the parameters configured here for all CoS queues.
Cfg. Parameter	Use the pull-down menu if you desire to configure a particular parameter of the WRED settings for a specified queue or port. The user may choose <i>All Parameters</i> , which will allow the user to configure <i>Drop Start</i> , <i>Drop Slope</i> and <i>Average Time</i> , simultaneously for a desired CoS queue, or select a specific parameter only to be configured. These parameters can be configured in the following three fields.
Drop Start	Select a percentage between 0 and 100 to initialize the discarding of random packets. This percentage is based on the fill percentage of the egress QoS queue stated in the Class ID field. (Once the specified queue reaches the target percentage specified here, the Switch will begin randomly discarding packets)
Drop Slope	The drop slope is a formula resulting in a degree which compares the average size of a queue to the percentage of the maximum and minimum Drop Start function previously stated. A value closer to 90° will wait a longer time before dropping packets than a value set closer to 0°.
Average Time	Enter a time, in microseconds, that the Switch will check the CoS queues to determine abnormalities in the settings and boundaries which will trigger the WRED function to initialize.

Click **Apply** to implement changes made.

Section 10

ACL

Access Profile Table

CPU Interface Filtering

Access profiles allow you to establish criteria to determine whether or not the Switch will forward packets based on the information contained in each packet's header. These criteria can be specified on a basis of Packet Content, MAC address, or IP address.

Access Profile Table

Creating an access profile is divided into two basic parts. The first is to specify which part or parts of a frame the Switch will examine, such as the MAC source address or the IP destination address. The second part is entering the criteria the Switch will use to determine what to do with the frame. The entire process is described below in two parts. To display the currently configured Access Profiles on the Switch, open the **ACL** folder and click the **Access Profile Table** link. This will open the **Access Profile Table** page, as shown below.

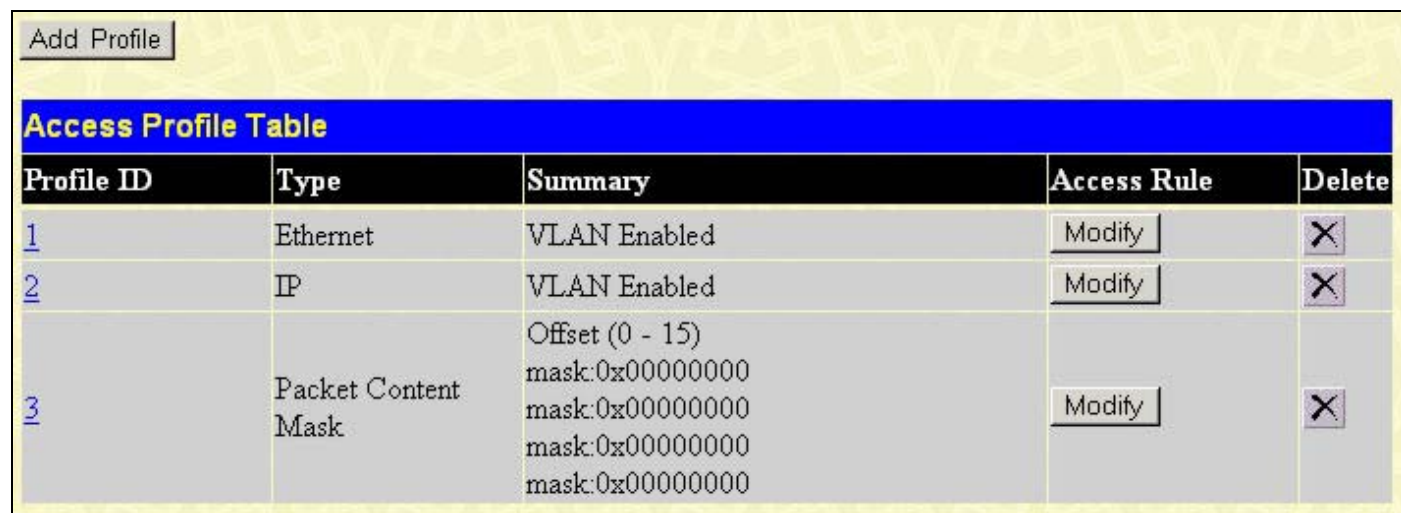

Access Profile Table				
Profile ID	Type	Summary	Access Rule	Delete
1	Ethernet	VLAN Enabled	<input type="button" value="Modify"/>	<input type="button" value="X"/>
2	IP	VLAN Enabled	<input type="button" value="Modify"/>	<input type="button" value="X"/>
3	Packet Content Mask	Offset (0 - 15) mask:0x00000000 mask:0x00000000 mask:0x00000000 mask:0x00000000	<input type="button" value="Modify"/>	<input type="button" value="X"/>

Figure 10- 1. Access Profile Table

To add an entry to the **Access Profile Table**, click the **Add Profile** button. This will open the **Access Profile Configuration** page, as shown below. There are three **Access Profile Configuration** pages; one for **Ethernet** (or MAC address-based) profile configuration, one for **IP** address-based profile configuration, and one for the **Packet Content Mask**. You can switch between the three **Access Profile Configuration** pages by using the **Type** drop-down menu. The page shown below is the **Ethernet Access Profile Configuration** page.

Access Profile Configuration

Profile ID (1-255)	4
Type	Ethernet
VLAN	<input type="checkbox"/>
Source MAC	<input type="checkbox"/> 00-00-00-00-00-00
Destination MAC	<input type="checkbox"/> 00-00-00-00-00-00
802.1p	<input type="checkbox"/>
Ethernet type	<input type="checkbox"/>

[Show All Access Profile Table Entries](#)

Figure 10- 2. Access Profile Table (Ethernet)

The following parameters can be set, for the **Ethernet** type:

Parameter	Description
Profile ID (1-255)	Type in a unique identifier number for this profile set. This value can be set from 1 – 255.
Type	Select profile based on Ethernet (MAC Address), IP address, or packet content mask. This will change the menu according to the requirements for the type of profile. <ul style="list-style-type: none"> Select <i>Ethernet</i> to instruct the Switch to examine the layer 2 part of each packet header. Select <i>IP</i> to instruct the Switch to examine the IP address in each frame's header. Select <i>Packet Content Mask</i> to specify a mask to hide the content of the packet header.
VLAN	Selecting this option instructs the Switch to examine the VLAN identifier of each packet header and use this as the full or partial criterion for forwarding.
Source MAC	Source MAC Mask - Enter a MAC address mask for the source MAC address.
Destination MAC	Destination MAC Mask - Enter a MAC address mask for the destination MAC address.
802.1p	Selecting this option instructs the Switch to examine the 802.1p priority value of each packet header and use this as the, or part of the criterion for forwarding.
Ethernet type	Selecting this option instructs the Switch to examine the Ethernet type value in each frame's header.

The page shown below is the **IP Access Profile Configuration** page.

Figure 10- 3. Access Profile Configuration (IP)

The following parameters can be set, for **IP**:

Parameter	Description
Profile ID (1-255)	Type in a unique identifier number for this profile set. This value can be set from 1 -255.
Type	Select profile based on Ethernet (MAC Address), IP address, Packet Content Mask. This will change the menu according to the requirements for the type of profile. <ul style="list-style-type: none"> Select <i>Ethernet</i> to instruct the Switch to examine the layer 2 part of each packet header. Select <i>IP</i> to instruct the Switch to examine the IP address in each frame's header. Select <i>Packet Content Mask</i> to specify a mask to hide the content of the packet header.
VLAN	Selecting this option instructs the Switch to examine the VLAN part of each packet header and use this as the, or part of the criterion for forwarding.
Source IP Mask	Enter an IP address mask for the source IP address.
Destination IP Mask	Enter an IP address mask for the destination IP address.
DSCP	Selecting this option instructs the Switch to examine the DiffServ Code part of each packet header and use this as the, or part of the criterion for forwarding.

Protocol	<p>Selecting this option instructs the Switch to examine the protocol type value in each frame's header. You must then specify what protocol(s) to include according to the following guidelines:</p> <p>Select ICMP to instruct the Switch to examine the Internet Control Message Protocol (ICMP) field in each frame's header.</p> <ul style="list-style-type: none"> Select Type to further specify that the access profile will apply an ICMP type value, or specify Code to further specify that the access profile will apply an ICMP code value. <p>Select IGMP to instruct the Switch to examine the Internet Group Management Protocol (IGMP) field in each frame's header.</p> <ul style="list-style-type: none"> Select Type to further specify that the access profile will apply an IGMP type value <p>Select TCP to use the TCP port number contained in an incoming packet as the forwarding criterion. Selecting TCP requires that you specify a source port mask and/or a destination port mask. The user may also identify which flag bits to filter. Flag bits are parts of a packet that determine what to do with the packet. The user may filter packets by filtering certain flag bits within the packets, by checking the boxes corresponding to the flag bits of the TCP field. The user may choose between urg (urgent), ack (acknowledgement), psb (push), rst (reset), syn (synchronize), fin (finish).</p> <ul style="list-style-type: none"> src port mask - Specify a TCP port mask for the source port in hex form (hex 0x0-0xffff), which you wish to filter. dest port mask - Specify a TCP port mask for the destination port in hex form (hex 0x0-0xffff) which you wish to filter. <p>Select UDP to use the UDP port number contained in an incoming packet as the forwarding criterion. Selecting UDP requires that you specify a source port mask and/or a destination port mask.</p> <ul style="list-style-type: none"> src port mask - Specify a TCP port mask for the source port in hex form (hex 0x0-0xffff). dest port mask - Specify a TCP port mask for the destination port in hex form (hex 0x0-0xffff). <p>protocol id - Enter a value defining the protocol ID in the packet header to mask. Specify the protocol ID mask in hex form (hex 0x0-0xffffffff) or a user value.</p>
-----------------	---

Click **Apply** to implement changes made.

The page shown below is the **ACL Packet Content Mask** configuration window.

Figure 10- 4. Access Profile Configuration (Packet Content Mask)

This screen will aid the user in configuring the Switch to mask packet headers beginning with the offset value specified. The following fields are used to configure the **Packet Content Mask**:

Parameter	Description
Profile ID (1-255)	Type in a unique identifier number for this profile set. This value can be set from 1 - 255.
Type	<p>Select profile based on Ethernet (MAC Address), IP address, or packet content mask. This will change the menu according to the requirements for the type of profile.</p> <ul style="list-style-type: none"> • Select <i>Ethernet</i> to instruct the Switch to examine the layer 2 part of each packet header. • Select <i>IP</i> to instruct the Switch to examine the IP address in each frame's header. • Select <i>Packet Content Mask</i> to specify a mask to hide the content of the packet header.
Offset	<p>This field will instruct the Switch to mask the packet header beginning with the offset value specified:</p> <ul style="list-style-type: none"> • <i>value (0-15)</i> - Enter a value in hex form to mask the packet from the beginning of the packet to the 15th byte. • <i>value (16-31)</i> – Enter a value in hex form to mask the packet from byte 16 to byte 31. • <i>value (32-47)</i> – Enter a value in hex form to mask the packet from byte 32 to byte 47. • <i>value (48-63)</i> – Enter a value in hex form to mask the packet from byte 48 to byte 63. • <i>value (64-79)</i> – Enter a value in hex form to mask the packet from byte 64 to byte 79.

Click **Apply** to implement changes made.

To establish the rule for a previously created Access Profile:

In the ACL folder, click the **Access Profile Table** link opening the **Access Profile Table**. The window shown below will appear.

Access Profile Table				
Profile ID	Type	Summary	Access Rule	Delete
1	Ethernet	VLAN Enabled	<input type="button" value="Modify"/>	<input type="button" value="X"/>
2	IP	VLAN Enabled	<input type="button" value="Modify"/>	<input type="button" value="X"/>
3	Packet Content Mask	Offset (0 - 15) mask:0x00000000 mask:0x00000000 mask:0x00000000 mask:0x00000000	<input type="button" value="Modify"/>	<input type="button" value="X"/>

Figure 10- 5. Access Profile Table window

To create a new rule set for an access profile click the **Add** button. The window shown below (**Access Profile Rule**) will be displayed. To remove a previously created rule, click the corresponding button.

Access Rule Table					
Profile ID	Mode	Type	Summary	Detail	Delete
1	Permit	Ethernet	Access ID: 1	<input type="button" value="View"/>	<input type="button" value="X"/>

[Show All Access Profile Entries](#)

Figure 10- 6. Access Rule Table

Click **Add Rule** to add a new Rule for an existing profile. The **Access Rule Configuration** window will appear.

To remove a previously created rule, select it and click the button. To add a new Access Rule, click the **Add Rule** button, and the Access Rule Configuration window will appear:

Figure 10- 7. Access Rule Configuration window - Ethernet.

To set the Access Rule for Ethernet, adjust the following parameters and click **Apply**.

Parameters	Description
Profile ID	This is the identifier number for this profile set.
Mode	Select Permit to specify that the packets that match the access profile are forwarded by the Switch, according to any additional rule added (see below). Select Deny to specify that packets that do not match the access profile are not forwarded by the Switch and will be filtered.
Access ID	Type in a unique identifier number for this access. This value can be set from 1 - 65535. <ul style="list-style-type: none"> • Auto Assign – Checking this field will instruct the Switch to automatically assign an Access ID for the rule being created.
Type	Selected profile based on Ethernet (MAC Address), IP address, Packet Content Mask . <ul style="list-style-type: none"> • <i>Ethernet</i> instructs the Switch to examine the layer 2 part of each packet header. • <i>IP</i> instructs the Switch to examine the IP address in each frame's header. • <i>Packet Content Mask</i> instructs the Switch to examine the packet header.
Priority (0-7)	This parameter is specified if you want to re-write the 802.1p default priority previously set in the Switch, which is used to determine the CoS queue to which packets are forwarded to. Once this field is specified, packets accepted by the Switch that match this priority are forwarded to the CoS queue specified previously by the user. <i>Replace priority with</i> – Click the corresponding box if you want to re-write the 802.1p default priority of a packet to the value entered in the Priority field, which meets the criteria specified previously in this command, before forwarding it on to the specified CoS queue. Otherwise, a packet will have its incoming 802.1p user priority re-written to its original value before being forwarded by the Switch. For more information on priority queues, CoS queues and mapping for 802.1p, see the QoS section of this manual.
VLAN Name	Allows the entry of a name for a previously configured VLAN.
Source MAC	Source MAC Address - Enter a MAC Address for the source MAC address.

Destination MAC	Destination MAC Address - Enter a MAC Address mask for the destination MAC address.
802.1p (0-7)	Enter a value from 0-7 to specify that the access profile will apply only to packets with this 802.1p priority value.
Ethernet Type	Specifies that the access profile will apply only to packets with this hexadecimal 802.1Q Ethernet type value (hex 0x0-0xffff) in the packet header. The Ethernet type value may be set in the form: hex 0x0-0xffff, which means the user may choose any combination of letters and numbers ranging from a-f and from 0-9999.
Port	The Access Rule may be configured on a per-port basis by entering the port number of the switch in the switch stack into this field. When a range of ports is to be configured, the Auto Assign check box MUST be clicked in the Access ID field of this window. If not, the user will be presented with an error message and the access rule will not be configured. The beginning and end of the port list range are separated by a dash. For example, 3 specifies port 3. 2 - 4 specifies the range of ports from 2 to 4.

To view the settings of a previously, correctly configured rule, click [View](#) in the **Access Rule Table** to view the window shown below. Clicking the hyperlink for the Profile ID on the **Access Profile Table** will also bring up the **Access Rule Display** window.

Access Rule Display	
Profile ID	1
Access ID	1
Mode	Permit
Type	Ethernet
Priority	-----
Replace Dscp	-----
VLAN Name	Trinity
Source MAC	-----
Destination MAC	-----
802.1p	-----
Ethernet Type	-----
Port	10

[Show All Access Rule Entries](#)

Figure 10- 8. Access Rule Display window (Ethernet)

Figure 10- 9. Access Rule Configuration window (IP)

Configure the following **Access Rule Configuration** settings for IP:

Parameter	Description
Profile ID	This is the identifier number for this profile set.
Mode	Select Permit to specify that the packets that match the access profile are forwarded by the Switch, according to any additional rule added (see below). Select Deny to specify that packets that do not match the access profile are not forwarded by the Switch and will be filtered.
Access ID	Type in a unique identifier number for this access. This value can be set from 1 - 65535. <ul style="list-style-type: none"> • Auto Assign – Checking this field will instruct the Switch to automatically assign an Access ID for the rule being created.
Type	Selected profile based on Ethernet (MAC Address), IP address, or Packet Content Mask . <ul style="list-style-type: none"> • <i>Ethernet</i> instructs the Switch to examine the layer 2 part of each packet header. • <i>IP</i> instructs the Switch to examine the IP address in each frame's header. • <i>Packet Content Mask</i> instructs the Switch to examine the packet header.
Priority (0-7)	This parameter is specified if you want to re-write the 802.1p default priority previously set in the Switch, which is used to determine the CoS queue to which packets are forwarded to. Once this field is specified, packets accepted by the Switch that match this priority are forwarded to the CoS queue specified previously by the user. <i>Replace priority with</i> – Click the corresponding box if you want to re-write the 802.1p default priority of a packet to the value entered in the Priority field, which meets the criteria specified previously in this command, before forwarding it on to the specified CoS queue. Otherwise, a packet will have its incoming 802.1p user priority re-written to its original value before being forwarded by the Switch. For more information on priority queues, CoS queues and mapping for 802.1p, see the QoS section of this manual.
Replace Dscp (0-63)	Select this option to instruct the Switch to replace the DSCP value (in a packet that meets the selected criteria) with the value entered in the adjacent field.

VLAN Name	Allows the entry of a name for a previously configured VLAN.
Source IP	Source IP Address - Enter an IP Address mask for the source IP address.
Destination IP	Destination IP Address- Enter an IP Address mask for the destination IP address.
Dscp (0-63)	This field allows the user to enter a DSCP value in the space provided, which will instruct the Switch to examine the DiffServ Code part of each packet header and use this as the, or part of the criterion for forwarding. The user may choose a value between 0 and 63.
Protocol	This field allows the user to modify the protocol used to configure the Access Rule Table ; depending on which protocol the user has chosen in the Access Profile Table .
Port	The Access Rule may be configured on a per-port basis by entering the port or range of ports. When a range of ports is to be configured, the Auto Assign check box MUST be clicked in the Access ID field of this window. If not, the user will be presented with an error message and the access rule will not be configured. The beginning and end of the port list range are separated by a dash. For example, 3 specifies port 3. 2 - 4 specifies the range of ports from 2 to 4.

To view the settings of a previously correctly configured rule, click [View](#) in the **Access Rule Table**.

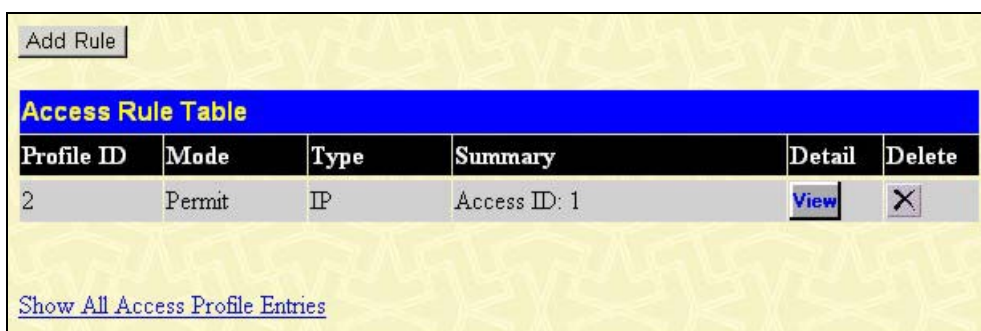

Figure 10- 10. Access Rule Table

The window shown below will appear. Clicking the hyperlink for the Profile ID on the **Access Profile Table**, will also bring up the **Access Rule Display** window.

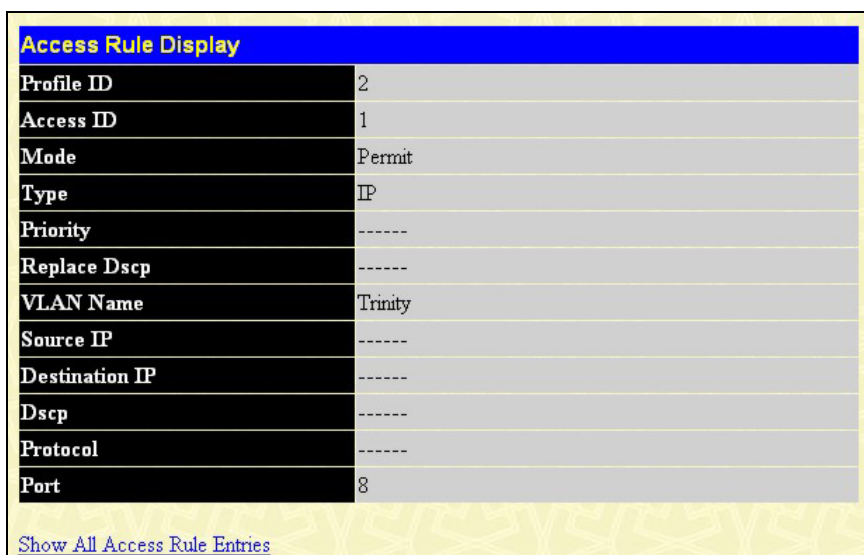

Figure 10- 11. Access Rule Display window (IP)

To configure the **Access Rule for Ethernet**, open the **Access Profile Table** (Figure 10-5) and click **Add** for an Ethernet entry. This will open the following screen:

To configure the Access Rule for **Packet Content Mask**, open the **Access Profile Table** and click **Modify** for a **Packet Content Mask** entry. This will open the following screen:

Access Rule Table					
Profile ID	Mode	Type	Summary	Detail	Delete
3	Permit	Packet Content Mask	Access ID: 1	View	<input type="button" value="X"/>

[Show All Access Profile Entries](#)

Figure 10- 12. Access Rule Table (Packet Content Mask)

To remove a previously created rule, click its corresponding button. To add a new Access Rule, click the **Add** button:

Access Rule Configuration

Profile ID: 3

Mode: Permit Deny

Access ID (1-65535): 2 Auto assign

Type: Packet Content Mask

Priority (0-7): replace priority

Replace Dscp (0-63):

Offset:

- value(0-15) mask: 00000000
- value(16-31) mask: 00000000
- value(32-47) mask: 00000000
- value(48-63) mask: 00000000
- value(64-79) mask: 00000000

Port:

Figure 10- 13. Access Rule Configuration - Packet Content Mask

To set the Access Rule for the **Packet Content Mask**, adjust the following parameters and click **Apply**.

Parameter	Description
Profile ID	This is the identifier number for this profile set.
Mode	Select Permit to specify that the packets that match the access profile are forwarded by the Switch, according to any additional rule added (see below). Select Deny to specify that packets that do not match the access profile are not forwarded by the Switch and will be filtered.
Access ID	Type in a unique identifier number for this access. This value can be set from 1 - 65535. <ul style="list-style-type: none"> Auto Assign – Checking this field will instruct the Switch to automatically assign an Access ID for the rule being created.

Type	<p>Selected profile based on Ethernet (MAC Address), IP address, or Packet Content Mask.</p> <ul style="list-style-type: none"> • <i>Ethernet</i> instructs the Switch to examine the layer 2 part of each packet header. • <i>IP</i> instructs the Switch to examine the IP address in each frame's header. • <i>Packet Content Mask</i> instructs the Switch to examine the packet header.
Priority	<p>This parameter is specified if you want to re-write the 802.1p default priority previously set in the Switch, which is used to determine the CoS queue to which packets are forwarded to. Once this field is specified, packets accepted by the Switch that match this priority are forwarded to the CoS queue specified previously by the user.</p> <p><i>Replace priority with</i> – Click the corresponding box if you want to re-write the 802.1p default priority of a packet to the value entered in the Priority field, which meets the criteria specified previously in this command, before forwarding it on to the specified CoS queue. Otherwise, a packet will have its incoming 802.1p user priority re-written to its original value before being forwarded by the Switch.</p> <p>For more information on priority queues, CoS queues and mapping for 802.1p, see the QoS section of this manual.</p>
Offset	<p>This field will instruct the Switch to mask the packet header beginning with the offset value specified:</p> <ul style="list-style-type: none"> • <i>value (0-15)</i> - Enter a value in hex form to mask the packet from the beginning of the packet to the 15th byte. • <i>value (16-31)</i> - Enter a value in hex form to mask the packet from byte 16 to byte 31. • <i>value (32-47)</i> - Enter a value in hex form to mask the packet from byte 32 to byte 47. • <i>value (48-63)</i> - Enter a value in hex form to mask the packet from byte 48 to byte 63. • <i>value (64-79)</i> - Enter a value in hex form to mask the packet from byte 64 to byte 79.
Port	<p>The Access Rule may be configured on a per-port basis by entering the port number of the switch in the switch stack into this field. When a range of ports is to be configured, the Auto Assign check box MUST be clicked in the Access ID field of this window. If not, the user will be presented with an error message and the access rule will not be configured. The beginning and end of the port list range are separated by a dash. For example, 3 specifies port 3. 2 - 4 specifies the range of ports from 2 to 4.</p>

To view the settings of a previously correctly configured rule, click [View](#) in the **Access Rule Table** to view the following screen:

Access Rule Display	
Profile ID	3
Access ID	1
Mode	Permit
Type	Packet Content Mask
Priority	-----
Replace Dscp	-----
Offset	Offset (0 - 15)
	mask:0x00000000
	mask:0x00000000
	mask:0x00000000
	mask:0x00000000
	Offset (16 - 31)
	mask:0x00000000
	mask:0x00000000
	mask:0x00000000
	mask:0x00000000
	Offset (32 - 47)
	mask:0x00000000
	mask:0x00000000
	mask:0x00000000
	mask:0x00000000
	Offset (48 - 63)
mask:0x00000000	
mask:0x00000000	
mask:0x00000000	
mask:0x00000000	
Offset (64 - 79)	
mask:0x00000000	
mask:0x00000000	
mask:0x00000000	
mask:0x00000000	
Port	7
Show All Access Rule Entries	

Figure 10- 14. Access Rule Display window (Packet Content Mask)

CPU Interface Filtering

Due to a chipset limitation and the need for extra switch security, the xStack DES-3800 switch series incorporates CPU Interface filtering. This added feature increases the running security of the Switch by enabling the user to create a list of access rules for packets destined for the Switch’s CPU interface. Employed similarly to the Access Profile feature previously mentioned, CPU interface filtering examines Ethernet, IP and Packet Content Mask packet headers destined for the CPU and will either forward them or filter them, based on the user’s implementation. As an added feature for the CPU Filtering, the Switch allows the CPU filtering mechanism to be enabled or disabled globally, permitting the user to create various lists of rules without immediately enabling them.

Creating an access profile for the CPU is divided into two basic parts. The first is to specify which part or parts of a frame the Switch will examine, such as the MAC source address or the IP destination address. The second part is entering the criteria the Switch will use to determine what to do with the frame. The entire process is described below.

CPU Interface Filtering Profile Table

Click **ACL > CPU Interface Filtering > CPU Interface Filtering Table** to display the CPU Access Profile Table entries created on the Switch. To view the configurations for an entry, click the hyperlinked **Profile ID** number.

CPU Interface Filtering Profile Table				
Profile ID	Type	Summary	Access Rule	Delete
1	Ethernet	VLAN Enabled	<input type="button" value="Modify"/>	<input type="button" value="X"/>
2	IP	VLAN Enabled	<input type="button" value="Modify"/>	<input type="button" value="X"/>
3	Packet Content Mask	Offset (0 - 15) mask:0x00000000 mask:0x00000000 mask:0x00000000 mask:0x00000000	<input type="button" value="Modify"/>	<input type="button" value="X"/>

Figure 10- 15. CPU Interface Filtering Table

To add an entry to the **CPU Interface Filtering Profile Table**, click the **Add** button. This will open the **CPU Interface Filtering Profile Configuration** page, as shown below. There are three **CPU Access Profile Configuration** pages; one for **Ethernet** (or MAC address-based) profile configuration, one for **IP** address-based profile configuration and one for the **Packet Content Mask**. You can switch between the three **CPU Access Profile Configuration** pages by using the **Type** drop-down menu. The page shown below is the **Ethernet CPU Interface Filtering Configuration** page.

CPU Interface Filtering Profile Configuration	
Profile ID (1-5)	<input type="text" value="4"/>
Type	Ethernet <input type="button" value="v"/>
VLAN	<input type="checkbox"/>
Source MAC	<input type="checkbox"/> <input type="text" value="00-00-00-00-00-00"/>
Destination MAC	<input type="checkbox"/> <input type="text" value="00-00-00-00-00-00"/>
802.1p	<input type="checkbox"/>
Ethernet type	<input type="checkbox"/>
<input type="button" value="Apply"/>	
Show All CPU Interface Filtering Profile Table Entries	

Figure 10- 16. CPU Interface Filtering Profile Configuration – Ethernet

Parameter	Description
Profile ID (1-5)	Type in a unique identifier number for this profile set. This value can be set from 1 - 5.
Type	Select profile based on Ethernet (MAC Address), IP address or packet content mask. This will change the menu according to the requirements for the type of profile. <ul style="list-style-type: none"> Select <i>Ethernet</i> to instruct the Switch to examine the layer 2 part of each packet header. Select <i>IP</i> to instruct the Switch to examine the IP address in each frame's header. Select <i>Packet Content Mask</i> to specify a mask to hide the content of the packet header.
VLAN	Selecting this option instructs the Switch to examine the VLAN identifier of each packet header and use this as the full or partial criterion for forwarding.
Source MAC	Source MAC Mask - Enter a MAC address mask for the source MAC address.
Destination MAC	Destination MAC Mask - Enter a MAC address mask for the destination MAC address.
802.1p	Enter a value from 0-7 to specify that the access profile will apply only to packets with this 802.1p priority value.
Ethernet type	Selecting this option instructs the Switch to examine the Ethernet type value in each frame's header.

Click **Apply** to set this entry in the Switch's memory.

The page shown below is the **CPU Interface Filtering Profile Configuration** for IP page.

CPU Interface Filtering Profile Configuration

Profile ID(1-5)

Type ▾

VLAN

Source IP Mask

Destination IP Mask

Dscp

Protocol

- ICMP type code
- IGMP type
- TCP
 - src port mask
 - dest port mask
 - flag bit
 - urg ack psh
 - rst syn fin
- UDP
 - src port mask
 - dest port mask
- protocol id
 - user value
 - user mask
 - user mask
 - user mask
 - user mask
 - user mask

[Show All CPU Interface Filtering Profile Table Entries](#)

Figure 10- 17. CPU Interface Filtering Configuration window- IP

The following parameters can be modified:

Parameter	Description
Profile ID (1-5)	Type in a unique identifier number for this profile set. This value can be set from 1 - 5.
Type	Select profile based on Ethernet (MAC Address), IP address or Packet Content Mask. This will change the menu according to the requirements for the type of profile. <ul style="list-style-type: none"> Select <i>Ethernet</i> to instruct the Switch to examine the layer 2 part of each packet header. Select <i>IP</i> to instruct the Switch to examine the IP address in each frame's header. Select <i>Packet Content Mask</i> to specify a mask to hide the content of the packet header.
VLAN	Selecting this option instructs the Switch to examine the VLAN part of each packet header and use this as the, or part of the criterion for forwarding.
Source IP Mask	Enter an IP address mask for the source IP address.
Destination IP Mask	Enter an IP address mask for the destination IP address.
DSCP	Selecting this option instructs the Switch to examine the DiffServ Code part of each packet header and use this as the, or part of the criterion for forwarding.
Protocol	Selecting this option instructs the Switch to examine the protocol type value in each frame's header. You must then specify what protocol(s) to include according to the following guidelines: Select ICMP to instruct the Switch to examine the Internet Control Message Protocol (ICMP) field in each frame's header. <ul style="list-style-type: none"> Select Type to further specify that the access profile will apply an ICMP type value, or specify Code to further specify that the access profile will apply an ICMP code value. Select IGMP to instruct the Switch to examine the Internet Group Management Protocol (IGMP) field in each frame's header. <ul style="list-style-type: none"> Select Type to further specify that the access profile will apply an IGMP type value. Select TCP to use the TCP port number contained in an incoming packet as the forwarding criterion. Selecting TCP requires that you specify a source port mask and/or a destination port mask. The user may also identify which flag bits to filter. Flag bits are parts of a packet that determine what to do with the packet. The user may filter packets by filtering certain flag bits within the packets, by checking the boxes corresponding to the flag bits of the TCP field. The user may choose between urg (urgent), ack (acknowledgement), psh (push), rst (reset), syn (synchronize), fin (finish). <ul style="list-style-type: none"> src port mask - Specify a TCP port mask for the source port in hex form (hex 0x0-0xffff), which you wish to filter. dest port mask - Specify a TCP port mask for the destination port in hex form (hex 0x0-0xffff) which you wish to filter. Select UDP to use the UDP port number contained in an incoming packet as the forwarding criterion. Selecting UDP requires that you specify a source port mask and/or a destination port mask. <ul style="list-style-type: none"> src port mask - Specify a TCP port mask for the source port in hex form (hex 0x0-0xffff). dest port mask - Specify a TCP port mask for the destination port in hex form (hex 0x0-0xffff). protocol id - Enter a value defining the protocol ID in the packet header to mask. Specify the protocol ID mask in hex form (hex 0x0-0xffffffff).

Click **Apply** to set this entry in the Switch's memory.

The page shown below is the **CPU Interface Filtering Profile Configuration** window for the **Packet Content Mask**.

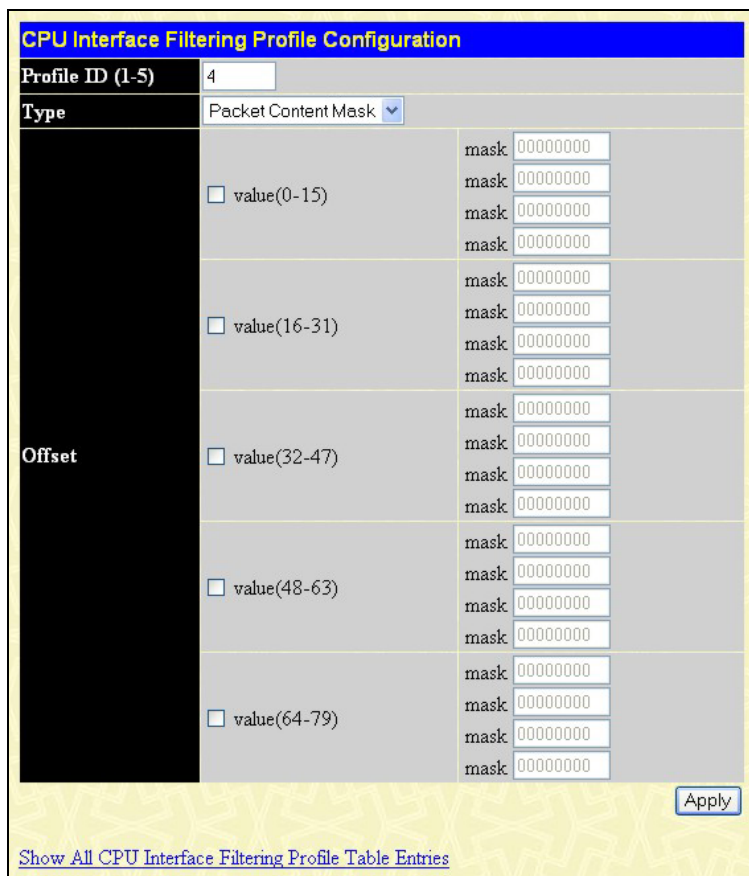

Figure 10- 18. CPU Interface Filtering Configuration window- Packet Content

This screen will aid the user in configuring the Switch to mask packet headers beginning with the offset value specified. The following fields are used to configure the **Packet Content Mask**:

Parameter	Description
Profile ID (1-4)	Type in a unique identifier number for this profile set. This value can be set from 1 - 5.
Type	<p>Select profile based on Ethernet (MAC Address), IP address or packet content mask. This will change the menu according to the requirements for the type of profile.</p> <ul style="list-style-type: none"> Select <i>Ethernet</i> to instruct the Switch to examine the layer 2 part of each packet header. Select <i>IP</i> to instruct the Switch to examine the IP address in each frame's header. Select <i>Packet Content Mask</i> to specify a mask to hide the content of the packet header.
Offset	<p>This field will instruct the Switch to mask the packet header beginning with the offset value specified:</p> <ul style="list-style-type: none"> <i>value (0-15)</i> - Enter a value in hex form to mask the packet from the beginning of the packet to the 15th byte. <i>value (16-31)</i> – Enter a value in hex form to mask the packet from byte 16 to byte 31. <i>value (32-47)</i> – Enter a value in hex form to mask the packet from byte 32 to byte 47. <i>value (48-63)</i> – Enter a value in hex form to mask the packet from byte 48 to byte 63. <i>value (64-79)</i> – Enter a value in hex form to mask the packet from byte 64 to byte 79.

Click **Apply** to implement changes made.

To establish the rule for a previously created CPU Access Profile:

In the ACL folder, click **CPU Interface Filtering** to open the **CPU Interface Filtering Profile Table**.

Profile ID	Type	Summary	Access Rule	Delete
1	Ethernet	VLAN Enabled	Modify	X
2	IP	VLAN Enabled	Modify	X
3	Packet Content Mask	Offset (0 - 15) mask:0x00000000 mask:0x00000000 mask:0x00000000 mask:0x00000000	Modify	X

Figure 10- 19. CPU Interface Filtering Profile Table - Add

In this window, the user may add a rule to a previously created CPU access profile by clicking the corresponding **Add Rule** button of the entry to configure **Ethernet, IP or Packet Content Mask**.

Profile ID	Mode	Type	Summary	Detail	Delete
1	Permit	Ethernet	Access ID: 1	View	X

[Show All CPU Interface Filtering Profile Entries](#)

Figure 10- 20. CPU Interface Filtering Rule Table

Click the **Add Rule** button to continue on to the **CPU Interface Filtering Rule Table** window. A new and unique window, for Ethernet, IP and Packet Content will open as shown in the examples below.

To change a rule for a previously created CPU Access Profile Rule:

In this window, the user may change a rule that has been previously created by clicking the corresponding **Modify** button of the entry.

Profile ID	Type	Summary	Access Rule	Delete
1	Ethernet	VLAN Enabled	Modify	X
2	IP	VLAN Enabled	Modify	X
3	Packet Content Mask	Offset (0 - 15) mask:0x00000000 mask:0x00000000 mask:0x00000000 mask:0x00000000	Modify	X

Figure 10- 21. CPU Interface Filtering Profile Table –Modify

The **CPU Interface Filtering Rule Table** will open. Click [View](#) to observe a previously created rule or to delete.

Add Rule

CPU Interface Filtering Rule Table					
Profile ID	Mode	Type	Summary	Detail	Delete
1	Deny	Ethernet	Access ID: 1	View	

[Show All CPU Interface Filtering Profile Entries](#)

Figure 10- 22. CPU Interface Filtering Rule Table – Ethernet

The CPU Interface Filtering Rule Configuration allows the user to create a rule for a previously created CPU Access Profile.

CPU Interface Filtering Rule Configuration	
Profile ID	1
Mode	<input checked="" type="radio"/> Permit <input type="radio"/> Deny
Access ID (1-65535)	2
Type	Ethernet
VLAN Name	
Source MAC	00-00-00-00-00-00
Destination MAC	00-00-00-00-00-00
802.1p (0-7)	0
Ethernet Type	

[Show All CPU Interface Filtering Rule Entries](#)

[Apply](#)

Figure 10- 23. CPU Interface Filtering Rule Configuration – Ethernet

To set the CPU Access Rule for Ethernet, adjust the following parameters and click **Apply**.

Parameters	Description
Profile ID	This is the identifier number for this profile set.
Mode	Select Permit to specify that the packets that match the access profile are forwarded by the Switch, according to any additional rule added (see below). Select Deny to specify that packets that do not match the access profile are not forwarded by the Switch and will be filtered.
Access ID	Type in a unique identifier number for this access and priority. This value can be set from 1 - 65535.
Type	Selected profile based on Ethernet (MAC Address), IP address or Packet Content. <ul style="list-style-type: none"> <i>Ethernet</i> instructs the Switch to examine the layer 2 part of each packet header. <i>IP</i> instructs the Switch to examine the IP address in each frame's header. <i>Packet Content Mask</i> instructs the Switch to examine the packet header.
VLAN Name	Allows the entry of a name for a previously configured VLAN.
Source MAC	Source MAC Address - Enter a MAC Address for the source MAC address.
Destination MAC	Destination MAC Address - Enter a MAC Address mask for the destination MAC address.

802.1P (0-7)	Enter a value from 0-7 to specify that the access profile will apply only to packets with this 802.1p priority value.
Ethernet Type	Specifies that the access profile will apply only to packets with this hexadecimal 802.1Q Ethernet type value (hex 0x0-0xffff) in the packet header. The Ethernet type value may be set in the form: hex 0x0-0xffff, which means the user may choose any combination of letters and numbers ranging from a-f and from 0-9999.

To view the settings of a previously configured rule, click [View](#) in the **Access Rule Table** to view the following screen:

CPU Interface Filtering Rule Display	
Profile ID	1
Access ID	1
Mode	Permit
Type	Ethernet
Priority	-----
Replace Dscp	-----
VLAN Name	Trinity
Source MAC	-----
Destination MAC	-----
802.1p	-----
Ethernet Type	-----

[Show All CPU Interface Filtering Rule Entries](#)

Figure 10- 24. CPU Interface Filtering Rule Display – Ethernet

The following window is the **CPU Interface Filtering Rule Table** for IP.

CPU Interface Filtering Rule Table					
Profile ID	Mode	Type	Summary	Detail	Delete
2	Permit	IP	Access ID: 1	View	<input type="button" value="X"/>

[Show All CPU Interface Filtering Profile Entries](#)

Figure 10- 25. CPU Interface Filtering Rule Table – IP

To create a new rule set for an access profile click the **Add** button. A new window is displayed. To remove a previously created rule, click the corresponding button. The following window is used for the CPU IP Rule configuration.

Figure 10- 26. CPU Interface Filtering Rule Configuration – IP

Configure the following **Access Rule Configuration** settings for IP:

Parameter	Description
Profile ID	This is the identifier number for this profile set.
Mode	Select Permit to specify that the packets that match the access profile are forwarded by the Switch, according to any additional rule added (see below). Select Deny to specify that packets that do not match the access profile are not forwarded by the Switch and will be filtered.
Access ID	Type in a unique identifier number for this access. This value can be set from 1 -65535.
Type	Selected profile based on Ethernet (MAC Address), IP address or Packet Content. <ul style="list-style-type: none"> • <i>Ethernet</i> instructs the Switch to examine the layer 2 part of each packet header. • <i>IP</i> instructs the Switch to examine the IP address in each frame's header. • <i>Packet Content Mask</i> instructs the Switch to examine the packet header.
VLAN Name	Allows the entry of a name for a previously configured VLAN.
Source IP	Source IP Address - Enter an IP Address mask for the source IP address.
Destination IP	Destination IP Address- Enter an IP Address mask for the destination IP address.
Dscp (0-63)	This field allows the user to enter a DSCP value in the space provided, which will instruct the Switch to examine the DiffServ Code part of each packet header and use this as the, or part of the criterion for forwarding. The user may choose a value between 0 and 63.
Protocol	This field allows the user to modify the protocol used to configure the Access Rule Table ; depending on which protocol the user has chosen in the Access Profile Table .

To view the settings of a previously correctly configured rule, click [View](#) in the **Access Rule Table** to view the following screen:

CPU Interface Filtering Rule Display	
Profile ID	2
Access ID	1
Mode	Permit
Type	IP
Priority	-----
Replace Dscp	-----
VLAN Name	Trinity
Source IP	-----
Destination IP	-----
Dscp	-----
Protocol	-----

[Show All CPU Interface Filtering Rule Entries](#)

Figure 10- 27. CPU Interface Filtering Rule Display - IP

The following window is the CPU Interface Filtering Rule Table for Packet Content.

Add

CPU Interface Filtering Rule Table					
Profile ID	Mode	Type	Summary	Detail	Delete
3	Permit	Packet Content Mask	Access ID: 1	View	<input type="button" value="X"/>

[Show All CPU Interface Filtering Profile Entries](#)

Figure 10- 28. CPU Interface Filtering Rule Table – Packet Content

To remove a previously created rule, select it and click the button. To add a new CPU Access Rule, click the **Add** button:

CPU Interface Filtering Rule Configuration		
Profile ID	3	
Mode	<input checked="" type="radio"/> Permit <input type="radio"/> Deny	
Access ID (1-65535)	2	
Type	Packet Content Mask	
Offset	<input type="checkbox"/> value(0-15)	mask 00000000
		mask 00000000
		mask 00000000
		mask 00000000
	<input type="checkbox"/> value(16-31)	mask 00000000
		mask 00000000
		mask 00000000
		mask 00000000
	<input type="checkbox"/> value(32-47)	mask 00000000
		mask 00000000
		mask 00000000
		mask 00000000
	<input type="checkbox"/> value(48-63)	mask 00000000
		mask 00000000
		mask 00000000
		mask 00000000
	<input type="checkbox"/> value(64-79)	mask 00000000
		mask 00000000
		mask 00000000
		mask 00000000

[Show All CPU Interface Filtering Rule Entries](#)

Figure 10- 29. CPU Interface Filtering Rule Configuration - Packet Content Mask

To set the Access Rule for Ethernet, adjust the following parameters and click **Apply**.

Parameters	Description
Profile ID	This is the identifier number for this profile set.
Mode	<p>Select Permit to specify that the packets that match the access profile are forwarded by the Switch, according to any additional rule added (see below).</p> <p>Select Deny to specify that packets that do not match the access profile are not forwarded by the Switch and will be filtered.</p>
Access ID	Type in a unique identifier number for this access. This value can be set from 1 - 65535.
Type	<p>Selected profile based on Ethernet (MAC Address), IP address or Packet Content.</p> <ul style="list-style-type: none"> • <i>Ethernet</i> instructs the Switch to examine the layer 2 part of each packet header. • <i>IP</i> instructs the Switch to examine the IP address in each frame's header. • <i>Packet Content Mask</i> instructs the Switch to examine the packet header.
Offset	<p>This field will instruct the Switch to mask the packet header beginning with the offset value specified:</p> <ul style="list-style-type: none"> • <i>value (0-15)</i> - Enter a value in hex form to mask the packet from the beginning of the packet to the 15th byte. • <i>value (16-31)</i> - Enter a value in hex form to mask the packet from byte 16 to byte 31. • <i>value (32-47)</i> - Enter a value in hex form to mask the packet from byte 32 to byte 47. • <i>value (48-63)</i> - Enter a value in hex form to mask the packet from byte 48 to byte 63. • <i>value (64-79)</i> - Enter a value in hex form to mask the packet from byte 64 to byte 79.

To view the settings of a previously correctly configured rule, click [View](#) in the **Access Rule Table** to view the following screen:

CPU Interface Filtering Rule Display	
Profile ID	3
Access ID	1
Mode	Permit
Type	Packet Content Mask
Priority	-----
	Offset (0 - 15)
	mask:0x00000000
	mask:0x00000000
	mask:0x00000000
	mask:0x00000000
	mask:0x00000000
	Offset (16 - 31)
	mask:0x00000000
	mask:0x00000000
	mask:0x00000000
	mask:0x00000000
	Offset (32 - 47)
	mask:0x00000000
Offset	mask:0x00000000
	mask:0x00000000
	mask:0x00000000
	Offset (48 - 63)
	mask:0x00000000
	mask:0x00000000
	mask:0x00000000
	mask:0x00000000
	Offset (64 - 79)
	mask:0x00000000
	mask:0x00000000
	mask:0x00000000
	mask:0x00000000

[Show All CPU Interface Filtering Rule Entries](#)

Figure 6- 55. CPU Interface Filtering Rule Display – Packet Content

Section 11

Security

Traffic Control

Port Security

Port Lock Entries

802.1X

Trusted Host

Access Authentication Control

Traffic Segmentation

SSL

SSH

IP MAC Binding

Limited IP Multicast Range Settings

WAC Configuration

Safeguard Engine

Traffic Control

On a computer network, packets such as Multicast packets and Broadcast packets continually flood the network as normal procedure. At times, this traffic may increase do to a malicious endstation on the network or a malfunctioning device, such as a faulty network card. Thus, switch throughput problems will arise and consequently affect the overall performance of the switch network. To help rectify this packet storm, the Switch will monitor and control the situation.

The packet storm is monitored to determine if too many packets are flooding the network, based on the threshold level provided by the user. Once a packet storm has been detected, the Switch will drop packets coming into the Switch until the storm has subsided. This method can be utilized by selecting the **Drop** option of the **Action** field in the window below.

The Switch will also scan and monitor packets coming into the Switch by monitoring the Switch's chip counter. This method is only viable for Broadcast and Multicast storms because the chip only has counters for these two types of packets. Once a storm has been detected (that is, once the packet threshold set below has been exceeded), the Switch will shutdown the port to all incoming traffic with the exception of STP BPDU packets, for a time period specified using the CountDown field. If this field times out and the packet storm continues, the port will be placed in a Shutdown Forever mode which will produce a warning message to be sent to the Trap Receiver. Once in Shutdown Forever mode, the only method of recovering this port is to manually recoup it using the **Port Configuration** window in the **Administration** folder and selecting the disabled port and returning it to an Enabled status. To utilize this method of Storm Control, choose the **Shutdown** option of the **Action** field in the window below.

To view the following window to configure Traffic Control, click **Security > Traffic Control**.

Trap Setting

Traffic Control Trap Apply

Traffic Control Trap: none

Traffic Control Settings

Storm Type Broadcast State: Disable

Action drop

Port List From: Port 1 To: Port 1

Threshold (pps) 128000

Time Interval 5

Countdown 0

Apply

Traffic Control Table

Port	Broadcast Storm (State / Threshold)	Multicast Storm (State / Threshold)	DLF (State / Threshold)	Action	Time Interval	Count down
1	Disabled / 128000	Disabled / 128000	Disabled / 128000	Drop	5	0
2	Disabled / 128000	Disabled / 128000	Disabled / 128000	Drop	5	0
3	Disabled / 128000	Disabled / 128000	Disabled / 128000	Drop	5	0
4	Disabled / 128000	Disabled / 128000	Disabled / 128000	Drop	5	0
5	Disabled / 128000	Disabled / 128000	Disabled / 128000	Drop	5	0
6	Disabled / 128000	Disabled / 128000	Disabled / 128000	Drop	5	0
7	Disabled / 128000	Disabled / 128000	Disabled / 128000	Drop	5	0
8	Disabled / 128000	Disabled / 128000	Disabled / 128000	Drop	5	0
9	Disabled / 128000	Disabled / 128000	Disabled / 128000	Drop	5	0
10	Disabled / 128000	Disabled / 128000	Disabled / 128000	Drop	5	0
11	Disabled / 128000	Disabled / 128000	Disabled / 128000	Drop	5	0
12	Disabled / 128000	Disabled / 128000	Disabled / 128000	Drop	5	0
13	Disabled / 128000	Disabled / 128000	Disabled / 128000	Drop	5	0
14	Disabled / 128000	Disabled / 128000	Disabled / 128000	Drop	5	0
15	Disabled / 128000	Disabled / 128000	Disabled / 128000	Drop	5	0
16	Disabled / 128000	Disabled / 128000	Disabled / 128000	Drop	5	0
17	Disabled / 128000	Disabled / 128000	Disabled / 128000	Drop	5	0
18	Disabled / 128000	Disabled / 128000	Disabled / 128000	Drop	5	0
19	Disabled / 128000	Disabled / 128000	Disabled / 128000	Drop	5	0
20	Disabled / 128000	Disabled / 128000	Disabled / 128000	Drop	5	0
21	Disabled / 128000	Disabled / 128000	Disabled / 128000	Drop	5	0
22	Disabled / 128000	Disabled / 128000	Disabled / 128000	Drop	5	0
23	Disabled / 128000	Disabled / 128000	Disabled / 128000	Drop	5	0
24	Disabled / 128000	Disabled / 128000	Disabled / 128000	Drop	5	0
25	Disabled / 128000	Disabled / 128000	Disabled / 128000	Drop	5	0
26	Disabled / 128000	Disabled / 128000	Disabled / 128000	Drop	5	0
27	Disabled / 128000	Disabled / 128000	Disabled / 128000	Drop	5	0
28	Disabled / 128000	Disabled / 128000	Disabled / 128000	Drop	5	0

Figure 6- 56. Traffic Control Settings and Traffic Control Table window

The user may set the following parameters:

Parameter	Description
Trap Setting	
Storm Trap	<p>Enable sending of Storm Trap messages when the type of action taken by the Traffic Control function in handling a Traffic Storm is one of the following:</p> <p><i>None</i> – Will send no Storm trap warning messages regardless of action taken by the Traffic Control mechanism.</p> <p><i>Storm Occurred</i> – Will send Storm Trap warning messages upon the occurrence of a Traffic Storm only.</p> <p><i>Storm Cleared</i> – Will send Storm Trap messages when a Traffic Storm has been cleared by the Switch only.</p> <p><i>Both</i> – Will send Storm Trap messages when a Traffic Storm has been both detected and cleared by the Switch.</p> <p>This function cannot be implemented in the Hardware mode. (When Drop is chosen in the Action field.</p>
Traffic Control Settings	
Storm Type	Select the type of Storm Type to detect, either Broadcast Multicast or DLF. Once selected , use the pull-down menu to enable or disable this storm detection.
Action	<p>Select the method of traffic Control from the pull down menu. The choices are:</p> <p><i>Drop</i> – Utilizes the hardware Traffic Control mechanism, which means the Switch's hardware will determine the Packet Storm based on the Threshold value stated and drop packets until the issue is resolved.</p> <p><i>Shutdown</i> – Utilizes the Switch's software Traffic Control mechanism to determine the Packet Storm occurring. Once detected, the port will deny all incoming traffic to the port except STP BPDUs, which are essential in keeping the Spanning Tree operational on the Switch. If the Countdown timer has expired and yet the Packet Storm continues, the port will be placed in Shutdown Forever mode and is no longer operational until the user manually resets the port using the Port Configuration window in the Administration folder and selecting the disabled port and returning it to an Enabled status. Choosing this option obligates the user to configure the Interval setting as well, which will provide packet count samplings from the Switch's chip to determine if a Packet Storm is occurring.</p>
Port List	Select the ports to be manually recovered from the Shutdown state.
Threshold	Specifies the maximum number of packets per second that will trigger the Traffic Control function to commence. The configurable threshold range is from 0-255000 with a default setting of 128000.
Time Interval	The Interval will set the time between Multicast and Broadcast packet counts sent from the Switch's chip to the Traffic Control function. These packet counts are the determining factor in deciding when incoming packets exceed the Threshold value. The Interval may be set between 5 and 30 seconds with the default setting of 5 seconds.
Count Down	The Count Down timer is set to determine the amount of time, in minutes, that the Switch will wait before shutting down the port that is experiencing a traffic storm. This parameter is only useful for ports configured as Shutdown in their Action field and therefore will not operate for Hardware based Traffic Control implementations. The possible time settings for this field are 0, 5-30 minutes. 0 is the default setting for this field and 0 will denote that the port will immediately shutdown.

Storm Trap	<p>Enable sending of Storm Trap messages when the type of action taken by the Traffic Control function in handling a Traffic Storm is one of the following:</p> <p><i>None</i> – Will send no Storm trap warning messages regardless of action taken by the Traffic Control mechanism.</p> <p><i>Storm Occurred</i> – Will send Storm Trap warning messages upon the occurrence of a Traffic Storm only.</p> <p><i>Storm Cleared</i> – Will send Storm Trap messages when a Traffic Storm has been cleared by the Switch only.</p> <p><i>Both</i> – Will send Storm Trap messages when a Traffic Storm has been both detected and cleared by the Switch.</p> <p>This function cannot be implemented in the Hardware mode. (When Drop is chosen in the Action field.)</p>
-------------------	--

Click Apply to implement the settings made.



NOTE: Traffic Control cannot be implemented on ports that are set for Link Aggregation (Port Trunking).



NOTE: Ports that are in the Shutdown forever mode will be seen as Discarding in Spanning Tree windows and implementations though these ports will still be forwarding BPDUs to the Switch's CPU.



NOTE: Ports that are in Shutdown Forever mode will be seen as link down in all windows and screens until the user recovers these ports.

Port Security

A given ports' (or a range of ports') dynamic MAC address learning can be locked such that the current source MAC addresses entered into the MAC address forwarding table can not be changed once the port lock is enabled. Using the **Admin State** pull-down menu to *Enabled*, and clicking **Apply** can lock the port.

Port Security is a security feature that prevents unauthorized computers (with source MAC addresses) unknown to the Switch prior to locking the port (or ports) from connecting to the Switch's locked ports and gaining access to the network. To view the following window, open the **Security** folder and click **Port Security**.

From	To	Admin State	Max.Addr (0-16)	Mode	Apply
Port 1	Port 1	Disabled	0	DeleteOnReset	Apply

Port	Admin State	Max.Learning Addr	Lock Address Mode
1	Disabled	1	DeleteOnReset
2	Disabled	1	DeleteOnReset
3	Disabled	1	DeleteOnReset
4	Disabled	1	DeleteOnReset
5	Disabled	1	DeleteOnReset
6	Disabled	1	DeleteOnReset
7	Disabled	1	DeleteOnReset
8	Disabled	1	DeleteOnReset
9	Disabled	1	DeleteOnReset
10	Disabled	1	DeleteOnReset
11	Disabled	1	DeleteOnReset
12	Disabled	1	DeleteOnReset
13	Disabled	1	DeleteOnReset
14	Disabled	1	DeleteOnReset
15	Disabled	1	DeleteOnReset
16	Disabled	1	DeleteOnReset
17	Disabled	1	DeleteOnReset
18	Disabled	1	DeleteOnReset
19	Disabled	1	DeleteOnReset
20	Disabled	1	DeleteOnReset
21	Disabled	1	DeleteOnReset
22	Disabled	1	DeleteOnReset
23	Disabled	1	DeleteOnReset
24	Disabled	1	DeleteOnReset
25	Disabled	1	DeleteOnReset
26	Disabled	1	DeleteOnReset
27	Disabled	1	DeleteOnReset
28	Disabled	1	DeleteOnReset

Figure 11- 1. Port Security Settings window

The following parameters can be set:

Parameter	Description
From/To	A consecutive group of ports may be configured starting with the selected port.
Admin State	This pull-down menu allows you to enable or disable Port Security (locked MAC address table for the selected ports).
Max. Learning Addr. (0-16)	The number of MAC addresses that will be in the MAC address-forwarding table for the selected switch and group of ports.
Lock Address Mode	This pull-down menu allows you to select how the MAC address table locking will be implemented on the Switch, for the selected group of ports. The options are: <ul style="list-style-type: none"> • <i>Permanent</i> – The locked addresses will not age out after the aging timer expires. • <i>DeleteOnTimeout</i> – The locked addresses will age out after the aging timer expires. • <i>DeleteOnReset</i> – The locked addresses will not age out until the Switch has been reset.

Click **Apply** to implement changes made.

Port Lock Entries

The **Port Lock Entries Table** window is used to remove an entry from the port security entries learned by the Switch and entered into the forwarding database. To view the following window, click **Security > Port Lock Entries**:

Port Lock Entries Table					
VID	VLAN Name	MAC Address	Port	Type	Delete

Figure 11- 2. Port Lock Entries Table

This function is only operable if the **Mode** in the **Port Security** window is selected as **Permanent** or **DeleteOnReset**, or in other words, only addresses that are permanently learned by the Switch can be deleted. Once the entry has been defined by entering the correct information into the window above, click the under the **Delete** heading of the corresponding MAC address to be deleted. Click the **Next** button to view the next page of entries listed in this table. This window displays the following information:

Parameter	Description
VID	The VLAN ID of the entry in the forwarding database table that has been permanently learned by the Switch.
VLAN NAME	The VLAN Name of the entry in the forwarding database table that has been permanently learned by the Switch.
MAC Address	The MAC address of the entry in the forwarding database table that has been permanently learned by the Switch.
Port	The ID number of the port that has permanently learned the MAC address.
Type	The type of MAC address in the forwarding database table. Only entries marked <i>Secured_Permanent</i> can be deleted.
Delete	Click the <input type="checkbox"/> in this field to delete the corresponding MAC address that was permanently learned by the Switch.

Port Access Entity (802.1X)

802.1x Port-Based and MAC-Based Access Control

The IEEE 802.1x standard is a security measure for authorizing and authenticating users to gain access to various wired or wireless devices on a specified Local Area Network by using a Client and Server based access control model. This is accomplished by using a RADIUS server to authenticate users trying to access a network by relaying Extensible Authentication Protocol over LAN (EAPOL) packets between the Client and the Server. The following figure represents a basic EAPOL packet:

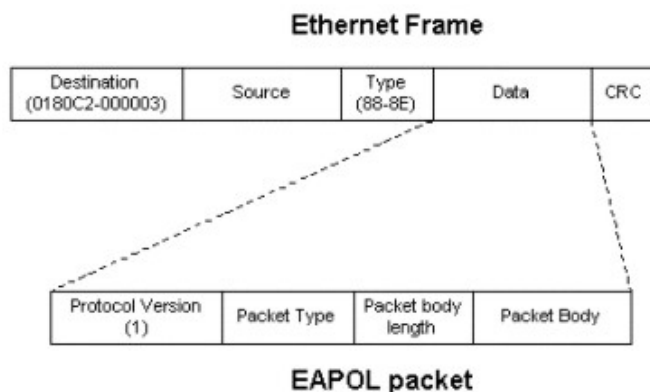

Figure 11- 3. The EAPOL Packet

Utilizing this method, unauthorized devices are restricted from connecting to a LAN through a port to which the user is connected. EAPOL packets are the only traffic that can be transmitted through the specific port until authorization is granted. The 802.1x Access Control method holds three roles, each of which are vital to creating and upkeeping a stable and working Access Control security method.

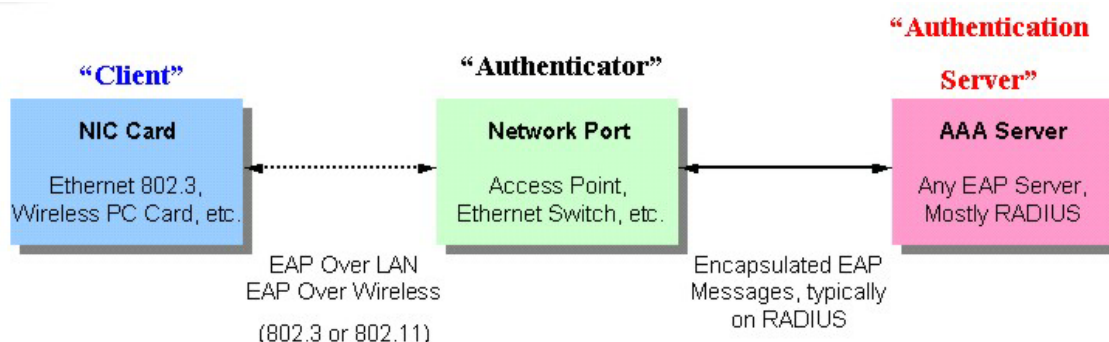

Figure 11- 4. The three roles of 802.1x

The following section will explain the three roles of Client, Authenticator and Authentication Server in greater detail.

Authentication Server

The Authentication Server is a remote device that is connected to the same network as the Client and Authenticator, must be running a RADIUS Server program and must be configured properly on the Authenticator (Switch). Clients connected to a port on the Switch must be authenticated by the Authentication Server (RADIUS) before attaining any services offered by the Switch on the LAN. The role of the Authentication Server is to certify the identity of the Client attempting to access the network by exchanging secure information between the RADIUS server and the Client through EAPOL packets and, in turn, informs the Switch whether or not the Client is granted access to the LAN and/or switches services.

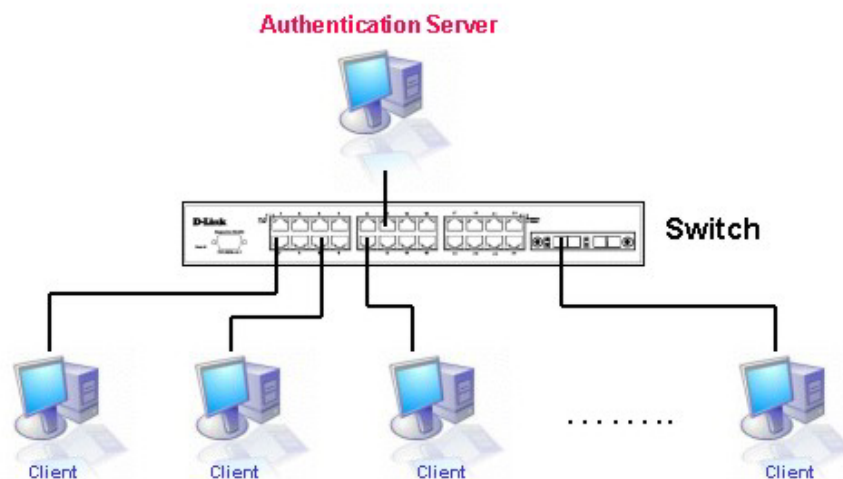

Figure 11- 5. The Authentication Server

Authenticator

The Authenticator (the Switch) is an intermediary between the Authentication Server and the Client. The Authenticator serves two purposes when utilizing 802.1x. The first purpose is to request certification information from the Client through EAPOL packets, which is the only information allowed to pass through the Authenticator before access is granted to the Client. The second purpose of the Authenticator is to verify the information gathered from the Client with the Authentication Server, and to then relay that information back to the Client.

Three steps must be implemented on the Switch to properly configure the Authenticator.

1. The 802.1x State must be *Enabled*. (**DES-3800 Web Management Tool**)
2. The 802.1x settings must be implemented by port (**Security / 802.1x / Configure 802.1X Authenticator Parameter**)
3. A RADIUS server must be configured on the Switch. (**Security / 802.1x / Authentic RADIUS Server**)

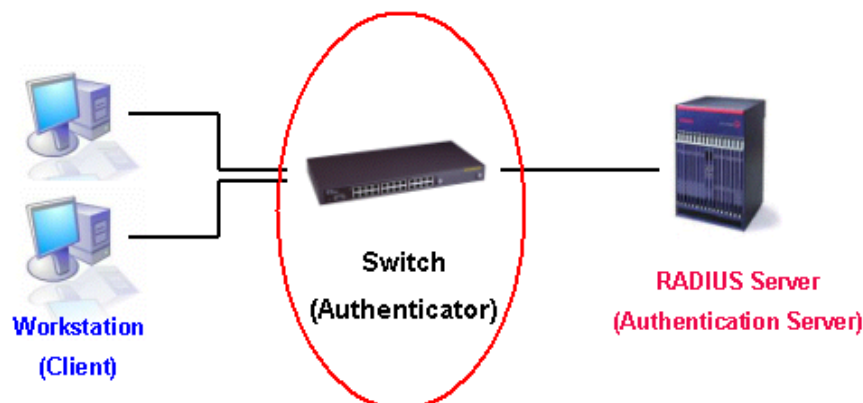

Figure 11- 6. The Authenticator

Client

The Client is simply the endstation that wishes to gain access to the LAN or switch services. All endstations must be running software that is compliant with the 802.1x protocol. For users running Windows XP, that software is included within the operating system. All other users are required to attain 802.1x client software from an outside source. The Client will request access to the LAN and or Switch through EAPOL packets and, in turn will respond to requests from the Switch.

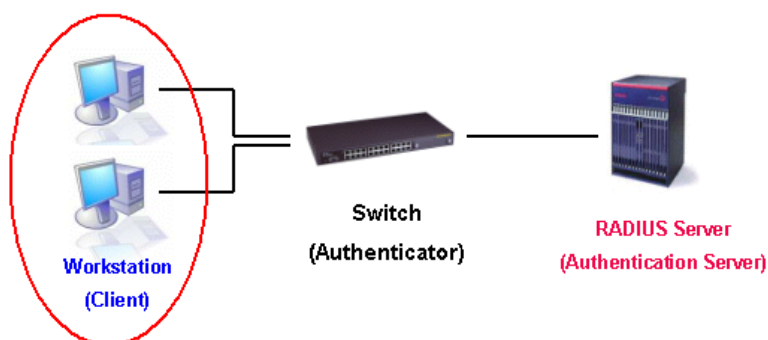

Figure 11- 7. The Client

Authentication Process

Utilizing the three roles stated above, the 802.1x protocol provides a stable and secure way of authorizing and authenticating users attempting to access the network. Only EAPOL traffic is allowed to pass through the specified port before a successful authentication is made. This port is “locked” until the point when a Client with the correct username and password (and MAC address if 802.1x is enabled by MAC address) is granted access and therefore successfully “unlocks” the port. Once unlocked, normal traffic is allowed to pass through the port. The following figure displays a more detailed explanation of how the authentication process is completed between the three roles stated above.

802.1X Authentication process

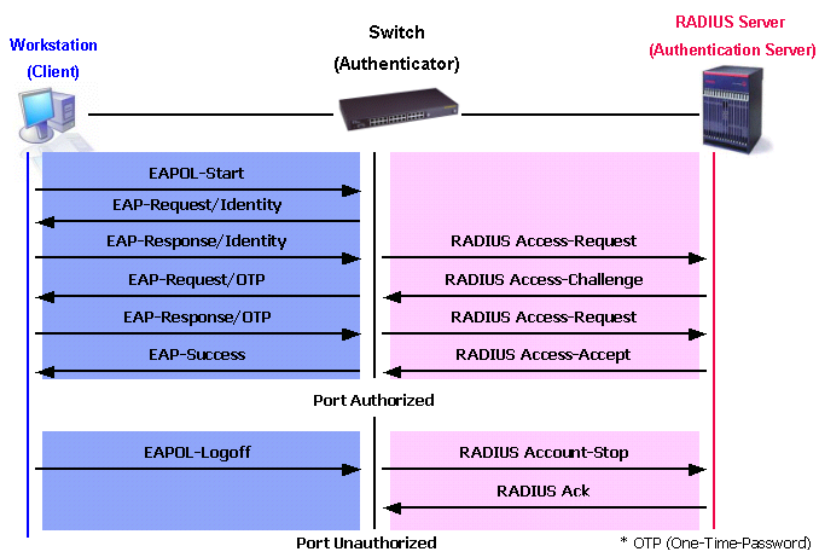

Figure 11- 8. The 802.1x Authentication Process

The D-Link implementation of 802.1x allows network administrators to choose between two types of Access Control used on the Switch, which are:

1. Port-Based Access Control – This method requires only one user to be authenticated per port by a remote RADIUS server to allow the remaining users on the same port access to the network.
2. MAC-Based Access Control – Using this method, the Switch will automatically learn up to three MAC addresses by port and set them in a list. Each MAC address must be authenticated by the Switch using a remote RADIUS server before being allowed access to the Network.

Understanding 802.1x Port-based and MAC-based Network Access Control

The original intent behind the development of 802.1X was to leverage the characteristics of point-to-point in LANs. As any single LAN segment in such infrastructures has no more than two devices attached to it, one of which is a Bridge Port. The Bridge Port detects events that indicate the attachment of an active device at the remote end of the link, or an active device becoming inactive. These events can be used to control the authorization state of the Port and initiate the process of authenticating the attached device if the Port is unauthorized. This is the Port-Based Network Access Control.

Port-Based Network Access Control

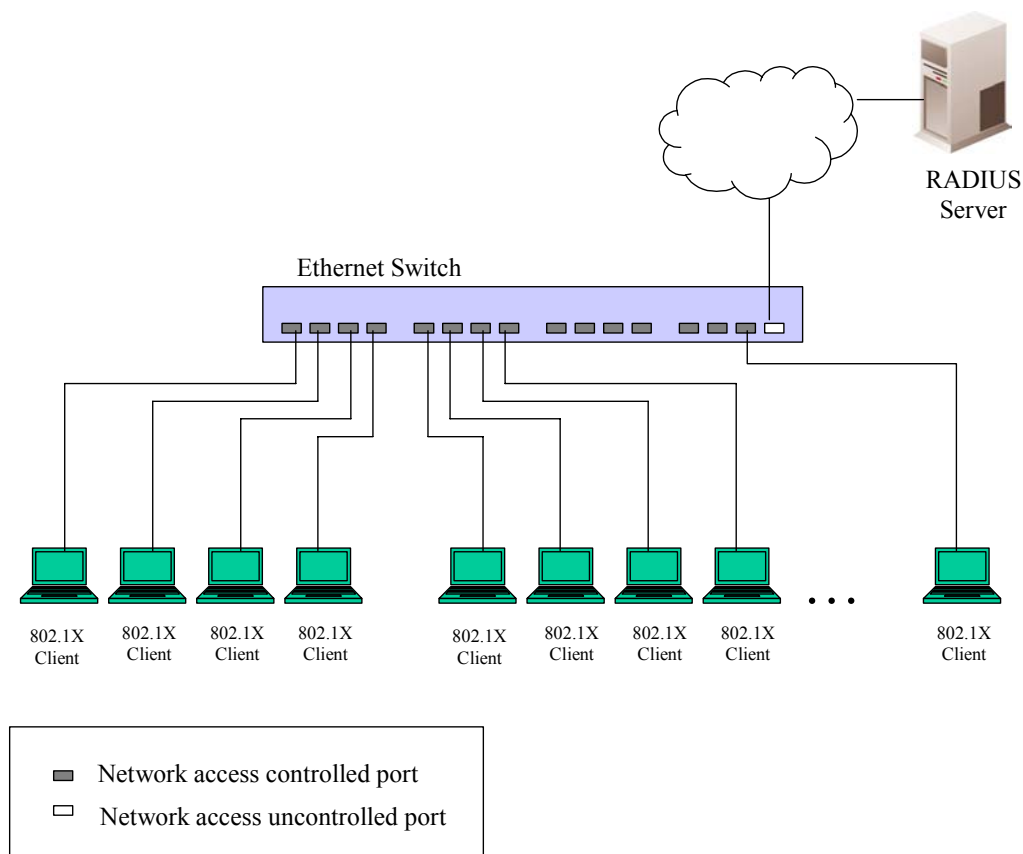

Figure 11- 9. Example of Typical Port-Based Configuration

Once the connected device has successfully been authenticated, the Port then becomes Authorized, and all subsequent traffic on the Port is not subject to access control restriction until an event occurs that causes the Port to become Unauthorized. Hence, if the Port is actually connected to a shared media LAN segment with more than one attached device, successfully authenticating one of the attached devices effectively provides access to the LAN for all devices on the shared segment. Clearly, the security offered in this situation is open to attack.

MAC-Based Network Access Control

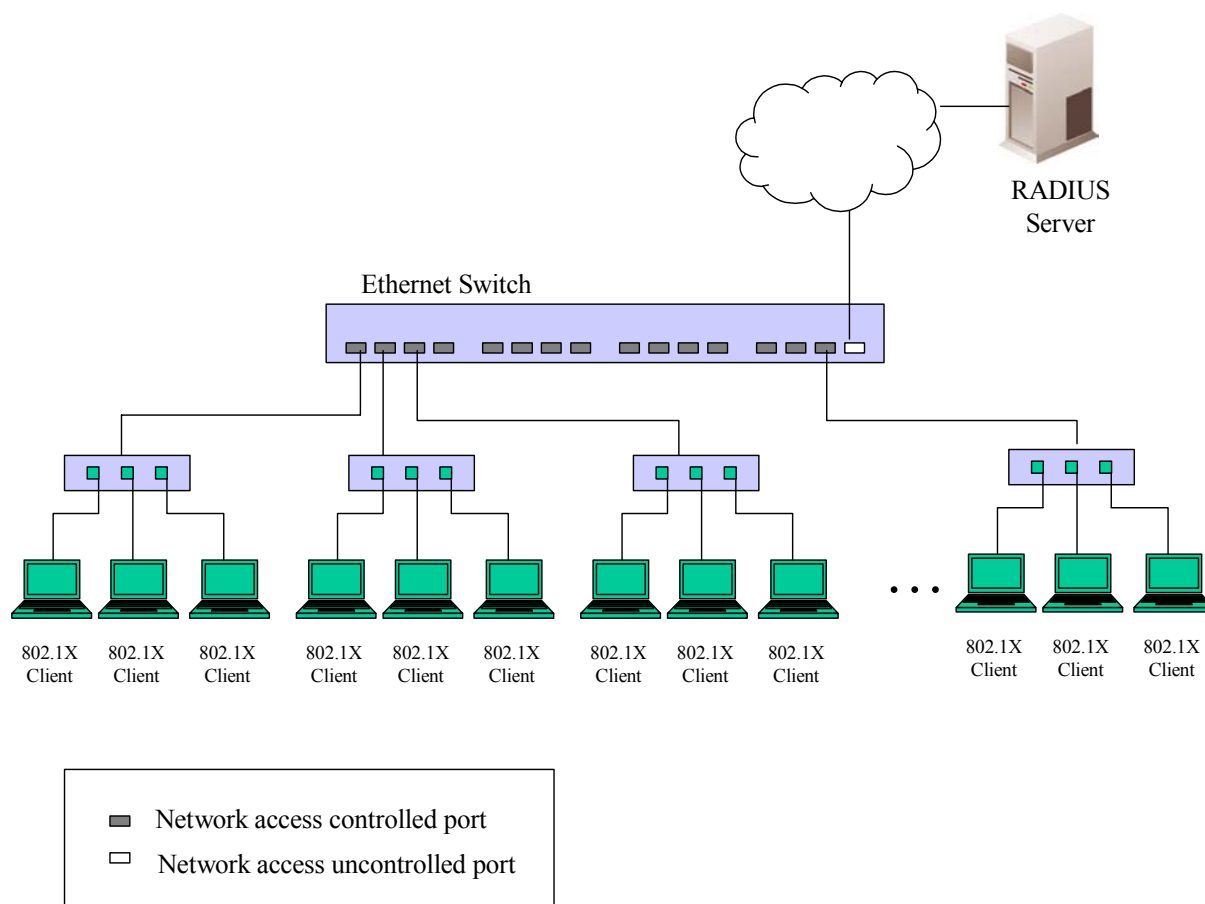

Figure 11- 10. Example of Typical MAC-Based Configuration

In order to successfully make use of 802.1X in a shared media LAN segment, it would be necessary to create “logical” Ports, one for each attached device that required access to the LAN. The Switch would regard the single physical Port connecting it to the shared media segment as consisting of a number of distinct logical Ports, each logical Port being independently controlled from the point of view of EAPOL exchanges and authorization state. The Switch learns each attached devices’ individual MAC addresses, and effectively creates a logical Port that the attached device can then use to communicate with the LAN via the Switch.

Configure 802.1x Authenticator Parameter

To configure the 802.1X Authenticator Settings, click **Security > Configure 802.1X Authenticator Parameter**:

Configure 802.1X Authenticator Parameter										
Port	AdmDir	Port Control	TxPeriod	Quiet Period	Supp-Timeout	Server-Timeout	MaxReq	ReAuth Period	ReAuth Enabled	Capability
1	both	Auto	30	60	30	30	2	3600	No	None
2	both	Auto	30	60	30	30	2	3600	No	None
3	both	Auto	30	60	30	30	2	3600	No	None
4	both	Auto	30	60	30	30	2	3600	No	None
5	both	Auto	30	60	30	30	2	3600	No	None
6	both	Auto	30	60	30	30	2	3600	No	None
7	both	Auto	30	60	30	30	2	3600	No	None
8	both	Auto	30	60	30	30	2	3600	No	None
9	both	Auto	30	60	30	30	2	3600	No	None
10	both	Auto	30	60	30	30	2	3600	No	None
11	both	Auto	30	60	30	30	2	3600	No	None
12	both	Auto	30	60	30	30	2	3600	No	None
13	both	Auto	30	60	30	30	2	3600	No	None
14	both	Auto	30	60	30	30	2	3600	No	None
15	both	Auto	30	60	30	30	2	3600	No	None
16	both	Auto	30	60	30	30	2	3600	No	None
17	both	Auto	30	60	30	30	2	3600	No	None
18	both	Auto	30	60	30	30	2	3600	No	None
19	both	Auto	30	60	30	30	2	3600	No	None
20	both	Auto	30	60	30	30	2	3600	No	None
21	both	Auto	30	60	30	30	2	3600	No	None
22	both	Auto	30	60	30	30	2	3600	No	None
23	both	Auto	30	60	30	30	2	3600	No	None
24	both	Auto	30	60	30	30	2	3600	No	None
25	both	Auto	30	60	30	30	2	3600	No	None
26	both	Auto	30	60	30	30	2	3600	No	None
27	both	Auto	30	60	30	30	2	3600	No	None
28	both	Auto	30	60	30	30	2	3600	No	None

Figure 11- 11. 802.1X Authenticator Settings window

To configure the settings by port, click on the hyperlinked port number under the Port heading, which will display the following table to configure:

802.1X Authenticator Settings	
From	Port 1
To	Port 1
AdmDir	both
PortControl	auto
TxPeriod	30
QuietPeriod	60
SuppTimeout	30
ServerTimeout	30
MaxReq	2
ReAuthPeriod	3600
ReAuth	Disabled
Capability	None

[Show Authenticators Setting](#) Apply

Figure 11- 12. 802.1X Authenticator Settings window (Modify)

This window allows you to set the following features:

Parameter	Description
From [] To []	Enter the port or ports to be set.
AdmCtrlDir <both>	<p>Sets the administrative-controlled direction to either <i>in</i> or <i>both</i>.</p> <p>If <i>in</i> is selected, control is only exerted over incoming traffic through the port you selected in the first field.</p> <p>If <i>both</i> are selected, control is exerted over both incoming and outgoing traffic through the controlled port selected in the first field.</p>
PortControl < Auto >	<p>This allows you to control the port authorization state.</p> <p>Select <i>forceAuthorized</i> to disable 802.1X and cause the port to transition to the authorized state without any authentication exchange required. This means the port transmits and receives normal traffic without 802.1X-based authentication of the client.</p> <p>If <i>forceUnauthorized</i> is selected, the port will remain in the unauthorized state, ignoring all attempts by the client to authenticate. The Switch cannot provide authentication services to the client through the interface.</p> <p>If <i>Auto</i> is selected, it will enable 802.1X and cause the port to begin in the unauthorized state, allowing only EAPOL frames to be sent and received through the port. The authentication process begins when the link state of the port transitions from down to up, or when an EAPOL-start frame is received. The Switch then requests the identity of the client and begins relaying authentication messages between the client and the authentication server.</p> <p>The default setting is <i>Auto</i>.</p>
TxPeriod [30]	This sets the TxPeriod of time for the authenticator PAE state machine. This value determines the period of an EAP Request/Identity packet transmitted to the client. The default setting is 30 seconds.
QuietPeriod [60]	This allows you to set the number of seconds that the Switch remains in the quiet state following a failed authentication exchange with the client. The default setting is 60 seconds.
SuppTimeout [30]	This value determines timeout conditions in the exchanges between the Authenticator and the client. The default setting is 30 seconds.
ServerTimeout [30]	This value determines timeout conditions in the exchanges between the Authenticator and the authentication server. The default setting is 30 seconds.

MaxReq [2]	The maximum number of times that the Switch will retransmit an EAP Request to the client before it times out of the authentication sessions. The default setting is 2.
ReAuthPeriod [3600]	A constant that defines a nonzero number of seconds between periodic reauthentication of the client. The default setting is 3600 seconds.
ReAuth <Disabled>	Determines whether regular reauthentication will take place on this port. The default setting is <i>Disabled</i> .
Capability	This allows the 802.1x Authenticator settings to be applied on a per-port basis. Select <i>Authenticator</i> to apply the settings to the port. When the setting is activated A user must pass the authentication process to gain access to the network. Select <i>None</i> disable 802.1x functions on the port.

Click **Apply** to implement your configuration changes.

Authentic RADIUS Server

The RADIUS feature of the Switch allows you to facilitate centralized user administration as well as providing protection against a sniffing, active hacker. The Web Manager offers three windows.

Click **Security > 802.1x > Authentic RADIUS Server** to open the **Authentic RADIUS Server** window shown below:

Figure 11- 13. Authentic RADIUS Server window

This window displays the following information:

Parameter	Description
Succession	Choose the desired RADIUS server to configure: <i>First</i> , <i>Second</i> or <i>Third</i> .
RADIUS Server	Set the RADIUS server IP.
Authentic Port	Set the RADIUS authentic server(s) UDP port. The default port is 1812.
Accounting Port	Set the RADIUS account server(s) UDP port. The default port is 1813.
Key	Set the key the same as that of the RADIUS server.
Confirm Key	Confirm the shared key is the same as that of the RADIUS server.
Status	This allows you to set the RADIUS Server as <i>Valid</i> (Enabled) or <i>Invalid</i> (Disabled).

Trusted Host

Go to the **Security** folder and click on the **Trusted Host** link; the following window will appear.

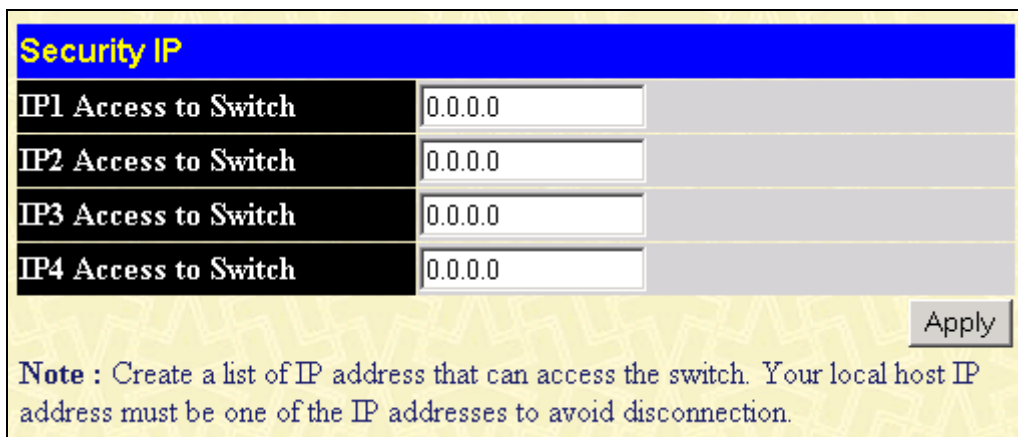

The screenshot shows a web interface window titled "Security IP". It contains a table with four rows, each representing an IP address for access to the switch. The first column lists the IP address, and the second column contains a text input field with "0.0.0.0" entered. To the right of the table is an "Apply" button. Below the table is a note: "Note : Create a list of IP address that can access the switch. Your local host IP address must be one of the IP addresses to avoid disconnection."

Security IP	
IP1 Access to Switch	<input type="text" value="0.0.0.0"/>
IP2 Access to Switch	<input type="text" value="0.0.0.0"/>
IP3 Access to Switch	<input type="text" value="0.0.0.0"/>
IP4 Access to Switch	<input type="text" value="0.0.0.0"/>

Apply

Note : Create a list of IP address that can access the switch. Your local host IP address must be one of the IP addresses to avoid disconnection.

Figure 11- 14. Security IP Management window

Use the Security IP Management to permit remote stations to manage the Switch. If you choose to define one or more designated management stations, only the chosen stations, as defined by IP address, will be allowed management privilege through the web manager or Telnet session. To define a management station IP setting, type in the IP address and click the **Apply** button.

Access Authentication Control

The TACACS/XTACACS/TACACS+/RADIUS commands let you secure access to the Switch using the TACACS/XTACACS/TACACS+/RADIUS protocols. When a user logs in to the Switch or tries to access the administrator level privilege, he or she is prompted for a password. If TACACS/XTACACS/TACACS+/RADIUS authentication is enabled on the Switch, it will contact a TACACS/XTACACS/TACACS+/RADIUS server to verify the user. If the user is verified, he or she is granted access to the Switch.

There are currently three versions of the TACACS security protocol, each a separate entity. The Switch's software supports the following versions of TACACS:

- **TACACS** (Terminal Access Controller Access Control System) - Provides password checking and authentication, and notification of user actions for security purposes utilizing via one or more centralized TACACS servers, utilizing the UDP protocol for packet transmission.
- **Extended TACACS (XTACACS)** - An extension of the TACACS protocol with the ability to provide more types of authentication requests and more types of response codes than TACACS. This protocol also uses UDP to transmit packets.
- **TACACS+ (Terminal Access Controller Access Control System plus)** - Provides detailed access control for authentication for network devices. TACACS+ is facilitated through Authentication commands via one or more centralized servers. The TACACS+ protocol encrypts all traffic between the Switch and the TACACS+ daemon, using the TCP protocol to ensure reliable delivery

In order for the TACACS/XTACACS/TACACS+/RADIUS security function to work properly, a TACACS/XTACACS/TACACS+/RADIUS server must be configured on a device other than the Switch, called an Authentication Server Host and it must include usernames and passwords for authentication. When the user is prompted by the Switch to enter usernames and passwords for authentication, the Switch contacts the TACACS/XTACACS/TACACS+/RADIUS server to verify, and the server will respond with one of three messages:

- The server verifies the username and password, and the user is granted normal user privileges on the Switch.
- The server will not accept the username and password and the user is denied access to the Switch.
- The server doesn't respond to the verification query. At this point, the Switch receives the timeout from the server and then moves to the next method of verification configured in the method list.

The Switch has four built-in **Authentication Server Groups**, one for each of the TACACS, XTACACS, TACACS+ and RADIUS protocols. These built-in Authentication Server Groups are used to authenticate users trying to access the Switch. The users will set **Authentication Server Hosts** in a preferable order in the built-in Authentication Server Groups and when a user tries to gain access to the Switch, the Switch will ask the first Authentication Server Hosts for authentication. If no authentication is made, the second server host in the list will be queried, and so on. The built-in Authentication Server Groups can only have hosts that are running the specified protocol. For example, the TACACS Authentication Server Groups can only have TACACS Authentication Server Hosts.

The administrator for the Switch may set up six different authentication techniques per user-defined method list (TACACS/XTACACS/TACACS+/RADIUS/local/none) for authentication. These techniques will be listed in an order preferable, and defined by the user for normal user authentication on the Switch, and may contain up to eight authentication techniques. When a user attempts to access the Switch, the Switch will select the first technique listed for authentication. If the first technique goes through its Authentication Server Hosts and no authentication is returned, the Switch will then go to the next technique listed in the server group for authentication, until the authentication has been verified or denied, or the list is exhausted.

Please note that users granted access to the Switch will be granted normal user privileges on the Switch. To gain access to administrator level privileges, the user must access the **Enable Admin** window and then enter a password, which was previously configured by the administrator of the Switch.



NOTE: TACACS, XTACACS and TACACS+ are separate entities and are not compatible. The Switch and the server must be configured exactly the same, using the same protocol. (For example, if the Switch is set up for TACACS authentication, so must be the host server.)

Authentication Policy and Parameter Settings

This command will enable an administrator-defined authentication policy for users trying to access the Switch. When enabled, the device will check the Login Method List and choose a technique for user authentication upon login.

To access the following window, click **Security > Access Authentication Control > Authentication Policy and Parameter Settings**:

Authentication Policy and Parameter Settings	
Authentication Policy	Disabled
Response Timeout (0-255)	30
User Attempts (1-255)	3
Apply	

Figure 11- 15. Policy & Parameters Settings window

The following parameters can be set:

Parameters	Description
Authentication Policy	Use the pull-down menu to enable or disable the Authentication Policy on the Switch.
Response Timeout (0-255)	This field will set the time the Switch will wait for a response of authentication from the user. The user may set a time between 0 and 255 seconds. The default setting is 30 seconds.
User Attempts (1-255)	This command will configure the maximum number of times the Switch will accept authentication attempts. Users failing to be authenticated after the set amount of attempts will be denied access to the Switch and will be locked out of further authentication attempts. Command line interface users will have to wait 60 seconds before another authentication attempt. Telnet and web users will be disconnected from the Switch. The user may set the number of attempts from 1 to 255. The default setting is 3.

Click **Apply** to implement changes made.

Application Authentication Settings

This window is used to configure switch configuration applications (console, Telnet, SSH, web) for login at the user level and at the administration level (Enable Admin) utilizing a previously configured method list. To view the following window, click **Security > Access Authentication Control > Application Authentication Settings**:

Application Authentication Settings		
Application	Login Method List	Enable Method List
Console	default	default
Telnet	default	default
SSH	default	default
HTTP	default	default
Apply		

Figure 11- 16. Application's Authentication Settings window

The following parameters can be set:

Parameter	Description
Application	Lists the configuration applications on the Switch. The user may configure the Login Method List and Enable Method List for authentication for users utilizing the Console (Command Line Interface) application, the Telnet application, SSH and the WEB (HTTP) application.
Login Method List	Using the pull down menu, configure an application for normal login on the user level, utilizing a previously configured method list. The user may use the default Method List or other Method List configured by the user. See the Login Method Lists window, in this section, for more information.
Enable Method List	Using the pull down menu, configure an application for normal login on the user level, utilizing a previously configured method list. The user may use the default Method List or other Method List configured by the user. See the Enable Method Lists window, in this section, for more information

Click **Apply** to implement changes made.

Authentication Server Group

This window will allow users to set up *Authentication Server Groups* on the Switch. A server group is a technique used to group TACACS/XTACACS/TACACS+/RADIUS server hosts into user-defined categories for authentication using method lists. The user may define the type of server group by protocol or by previously defined server group. The Switch has three built-in Authentication Server Groups that cannot be removed but can be modified. Up to eight authentications server hosts may be added to any particular group.

To view the following window, click **Security > Access Authentication Control > Authentication Server Group**:



Figure 11- 17. Authentication Server Group Settings window

This screen displays the Authentication Server Groups on the Switch. The Switch has four built-in Authentication Server Groups that cannot be removed but can be modified. To modify a particular group, click its hyperlinked Group Name, which will then display the following window.

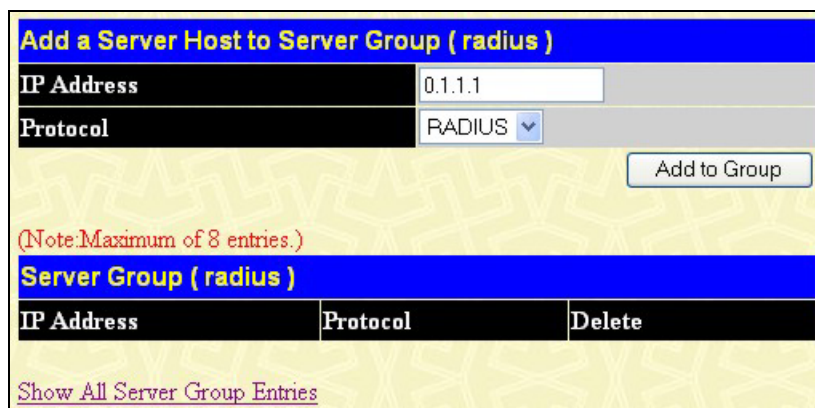

Figure 11- 18. Add a Server Host to Server Group (radius) window

To add an Authentication Server Host to the list, enter its IP address in the IP Address field, choose the protocol associated with the IP address of the Authentication Server Host and click **Add to Group** to add this Authentication Server Host to the group.

To add a user-defined group to the list, click the Add button in the **Authentication Server Group** window, which will display the following window.



Figure 11- 19. Authentication Server Group Table Add Settings

Simply enter a group name of no more than 15 alphanumeric characters to define the user group to add. After clicking **Apply**, the new user-defined group will be displayed in the **Authentication Server Group** window. Here, it can be configured as the user desires.



NOTE: The user must configure Authentication Server Hosts using the Authentication Server Hosts window before adding hosts to the list. Authentication Server Hosts must be configured for their specific protocol on a remote centralized server before this function can work properly.



NOTE: The four built in server groups can only have server hosts running the same TACACS daemon. TACACS/XTACACS/TACACS+ protocols are separate entities and are not compatible with each other.

Authentication Server Host

This window will set user-defined *Authentication Server Hosts* for the TACACS/XTACACS/TACACS+/RADIUS security protocols on the Switch. When a user attempts to access the Switch with Authentication Policy enabled, the Switch will send authentication packets to a remote TACACS/XTACACS/TACACS+/RADIUS server host on a remote host. The TACACS/XTACACS/TACACS+/RADIUS server host will then verify or deny the request and return the appropriate message to the Switch. More than one authentication protocol can be run on the same physical server host but, remember that TACACS/XTACACS/TACACS+/RADIUS are separate entities and are not compatible with each other. The maximum supported number of server hosts is 16.

To view the following window, click **Security > Access Authentication Control > Authentication Server Host**:

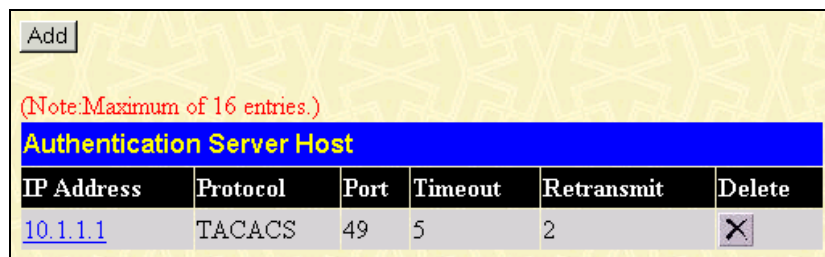

Figure 11- 20. Authentication Server Host Settings window

To add an Authentication Server Host, click the **Add** button, revealing the following window:

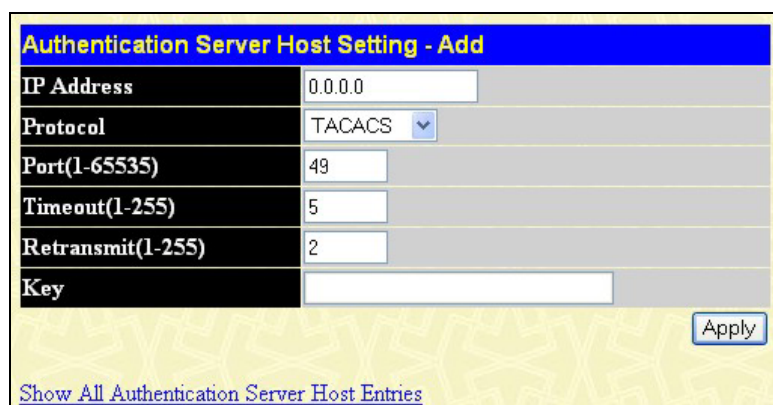

Figure 11- 21. Authentication Server Host Settings – Add window

To edit an Authentication Server Host, click the IP address hyperlink, revealing the following window:

Figure 11- 22. Authentication Server Host Setting –Edit window

Configure the following parameters to add an Authentication Server Host:

Parameter	Description
IP Address	The IP address of the remote server host the user wishes to add.
Protocol	The protocol used by the server host. The user may choose one of the following: <ul style="list-style-type: none"> • <i>TACACS</i> - Enter this parameter if the server host utilizes the TACACS protocol. • <i>XTACACS</i> - Enter this parameter if the server host utilizes the XTACACS protocol. • <i>TACACS+</i> - Enter this parameter if the server host utilizes the TACACS+ protocol. • <i>RADIUS</i> - Enter this parameter if the server host utilizes the RADIUS protocol.
Port (1-65535)	Enter a number between 1 and 65535 to define the virtual port number of the authentication protocol on a server host. The default port number is 49 for TACACS/XTACACS/TACACS+ servers and 1813 for RADIUS servers but the user may set a unique port number for higher security.
Timeout (1-255)	Enter the time in seconds the Switch will wait for the server host to reply to an authentication request. The default value is 5 seconds.
Retransmit (1-255)	Enter the value in the retransmit field to change how many times the device will resend an authentication request when the TACACS server does not respond.
Key	Authentication key to be shared with a configured TACACS+ or RADIUS servers only. Specify an alphanumeric string up to 254 characters.

Click **Apply** to add the server host.



NOTE: More than one authentication protocol can be run on the same physical server host but, remember that TACACS/XTACACS/TACACS+ are separate entities and are not compatible with each other

Login Method Lists

This command will configure a user-defined or default Login Method List of authentication techniques for users logging on to the Switch. The sequence of techniques implemented in this command will affect the authentication result. For example, if a user enters a sequence of techniques, for example TACACS – XTACACS - local, the Switch will send an authentication request to the first TACACS host in the server group. If no response comes from the server host, the Switch will send an authentication request to the second tacacs host in the server group and so on, until the list is exhausted. At that point, the Switch will restart the same sequence with the following protocol listed, XTACACS. If no authentication takes place using the XTACACS list, the local account database set in the Switch is used to authenticate the user. When the local method is used, the privilege level will be dependant on the local account privilege configured on the Switch.

Successful login using any of these techniques will give the user a "User" privilege only. If the user wishes to upgrade his or her status to the administrator level, the user must use the **Enable Admin** window, in which the user must enter a previously configured password, set by the administrator. (See the Enable Admin part of this section for more detailed information concerning the Enable Admin command.)

To view the following window click **Security > Access Authentication Control > Login Method Lists**:

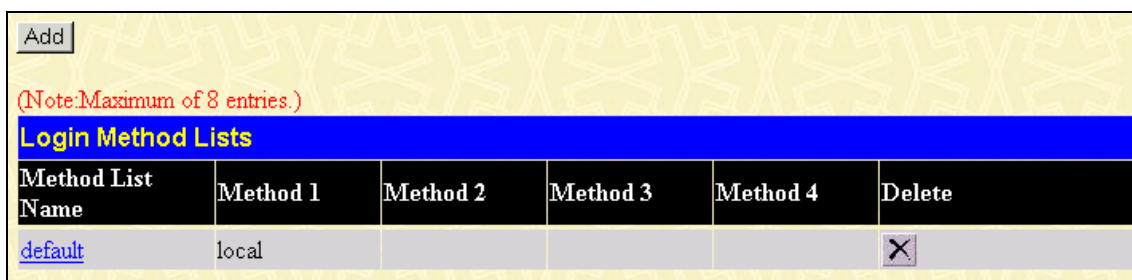

Figure 11- 23. Login Method Lists Settings window

The Switch contains one Method List that is set and cannot be removed, yet can be modified. To delete a Login Method List defined by the user, click the X under the Delete heading corresponding to the entry desired to be deleted. To modify a Login Method List, click on its hyperlinked Method List Name. To configure a new Method List, click the **Add** button.

Both actions will result in the same window to configure:



Figure 11- 24. Login Method List - Edit window (default)

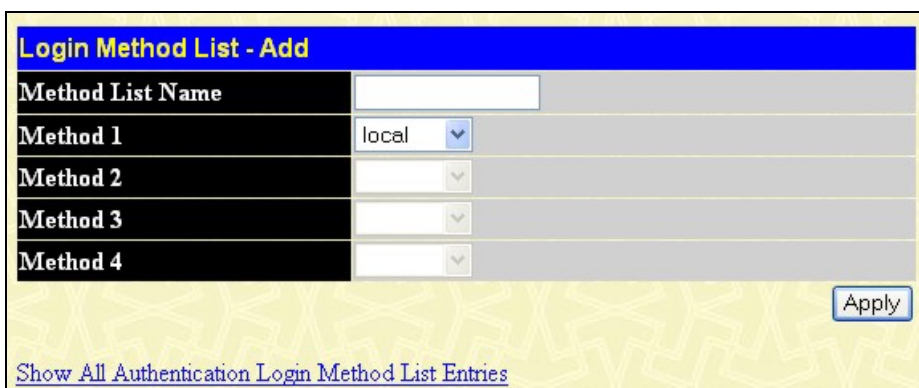

Figure 11- 25. Login Method List – Add window

To define a Login Method List, set the following parameters and click **Apply**:

Parameter	Description
Method List Name	Enter a method list name defined by the user of up to 15 characters.
Method 1, 2, 3, 4	<p>The user may add one, or a combination of up to four of the following authentication methods to this method list:</p> <ul style="list-style-type: none"> • <i>tacacs</i> - Adding this parameter will require the user to be authenticated using the TACACS protocol from a remote TACACS server. • <i>xtacacs</i> - Adding this parameter will require the user to be authenticated using the XTACACS protocol from a remote XTACACS server. • <i>tacacs+</i> - Adding this parameter will require the user to be authenticated using the TACACS+ protocol from a remote TACACS+ server. • <i>radius</i> - Adding this parameter will require the user to be authenticated using the RADIUS protocol from a remote RADIUS server. • <i>server_group</i> - Adding this parameter will require the user to be authenticated using a user-defined server group previously configured on the Switch. • <i>local</i> - Adding this parameter will require the user to be authenticated using the local user account database on the Switch. • <i>none</i> - Adding this parameter will require an authentication to access the Switch.

Enable Method Lists

The **Enable Method List Settings** window is used to set up Method Lists to promote users with user level privileges to Administrator (Admin) level privileges using authentication methods on the Switch. Once a user acquires normal user level privileges on the Switch, he or she must be authenticated by a method on the Switch to gain administrator privileges on the Switch, which is defined by the Administrator. A maximum of eight Enable Method Lists can be implemented on the Switch, one of which is a default Enable Method List. This default Enable Method List cannot be deleted but can be configured.

The sequence of methods implemented in this command will affect the authentication result. For example, if a user enters a sequence of methods like TACACS - XTACACS - Local Enable, the Switch will send an authentication request to the first TACACS host in the server group. If no verification is found, the Switch will send an authentication request to the second TACACS host in the server group and so on, until the list is exhausted. At that point, the Switch will restart the same sequence with the following protocol listed, XTACACS. If no authentication takes place using the XTACACS list, the Local Enable password set in the Switch is used to authenticate the user.

Successful authentication using any of these methods will give the user an "Admin" privilege.



NOTE: To set the Local Enable Password, see the next section, entitled Local Enable Password.

To view the following table, click **Security > Access Authentication Control > Enable Method Lists**:

Add					
(Note: Maximum of 8 entries.)					
Enable Method Lists					
Method List Name	Method 1	Method 2	Method 3	Method 4	Delete
default	local_enable				

Figure 11- 26. Enable Method List Settings window

To delete an Enable Method List defined by the user, click the under the Delete heading corresponding to the entry desired to be deleted. To modify an Enable Method List, click on its hyperlinked Method List Name. To configure a Method List, click the **Add** button.

Both actions will result in the same window to configure:

Figure 11- 27. Enable Method List - Edit window

Figure 11- 28. Enable Method List - Add window

To define an Enable Login Method List, set the following parameters and click **Apply**:

Parameter	Description
Method List Name	Enter a method list name defined by the user of up to 15 characters.
Method 1, 2, 3, 4	<p>The user may add one, or a combination of up to four of the following authentication methods to this method list:</p> <ul style="list-style-type: none"> <i>local_enable</i> - Adding this parameter will require the user to be authenticated using the local enable password database on the Switch. The user in the next section entitled Local Enable Password must set the local enable password. <i>none</i> - Adding this parameter will require an authentication to access the Switch. <i>radius</i> - Adding this parameter will require the user to be authenticated using the RADIUS protocol from a remote RADIUS server. <i>tacacs</i> - Adding this parameter will require the user to be authenticated using the TACACS protocol from a remote TACACS server. <i>xtacacs</i> - Adding this parameter will require the user to be authenticated using the XTACACS protocol from a remote XTACACS server. <i>tacacs+</i> - Adding this parameter will require the user to be authenticated using the TACACS protocol from a remote TACACS server. <i>server_group</i> - Adding a previously configured server group will require the user to be authenticated using a user-defined server group previously configured on the Switch.

Configure Local Enable Password

This window will configure the locally enabled password for the Enable Admin command. When a user chooses the "local_enable" method to promote user level privileges to administrator privileges, he or she will be prompted to enter the password configured here that is locally set on the Switch.

To view the following window, click **Security > Access Authentication Control > Configure Local Enable Password**:

Figure 11- 29. Configure Local Enable Password window

To set the Local Enable Password, set the following parameters and click **Apply**.

Parameter	Description
Old Local Enabled	If a password was previously configured for this entry, enter it here in order to change it to a new password
New Local Enabled	Enter the new password that you wish to set on the Switch to authenticate users attempting to access Administrator Level privileges on the Switch. The user may set a password of up to 15 characters.
Confirm Local Enabled	Confirm the new password entered above. Entering a different password here from the one set in the New Local Enabled field will result in a fail message.

Enable Admin

The **Enable Admin** window is for users who have logged on to the Switch on the normal user level, and wish to be promoted to the administrator level. After logging on to the Switch, users will have only user level privileges. To gain access to administrator level privileges, the user will open this window and will have to enter an authentication password. Possible authentication methods for this function include TACACS/XTACACS/TACACS+/RADIUS, user defined server groups, local enable (local account on the Switch), or no authentication (none). Because XTACACS and TACACS do not support the enable function, the user must create a special account on the server host, which has the username "enable", and a password configured by the administrator that will support the "enable" function. This function becomes inoperable when the authentication policy is disabled.

When this window appears, click the **Enable Admin** button revealing a dialog box for the user to enter authentication (password, username), as seen below. A successful entry will promote the user to Administrator level privileges on the Switch.

To view the following window, click **Security > Access Authentication Control > Enable Admin**:

Figure 11- 30. Enable Admin Screen

Figure 11- 31. Enter Network Password dialog box

Traffic Segmentation

Traffic segmentation is used to limit traffic flow from a single port to a group of ports on either a single switch or a group of ports on another switch in a switch stack. This method of segmenting the flow of traffic is similar to using VLANs to limit traffic, but is more restrictive. It provides a method of directing traffic that does not increase the overhead of the Master switch CPU. In the **Security** folder, click **Traffic Segmentation** to view the screen shown below.



Figure 11- 32. Current Traffic Segmentation Table

This page allows you to view which port on a given switch will be allowed to forward packets to other ports on that switch. Select a port number from the drop down menu and click **View** display the forwarding ports. To configure new forwarding ports for a particular port, select a port from the drop down menu and click **Setup**. The window shown below will appear.

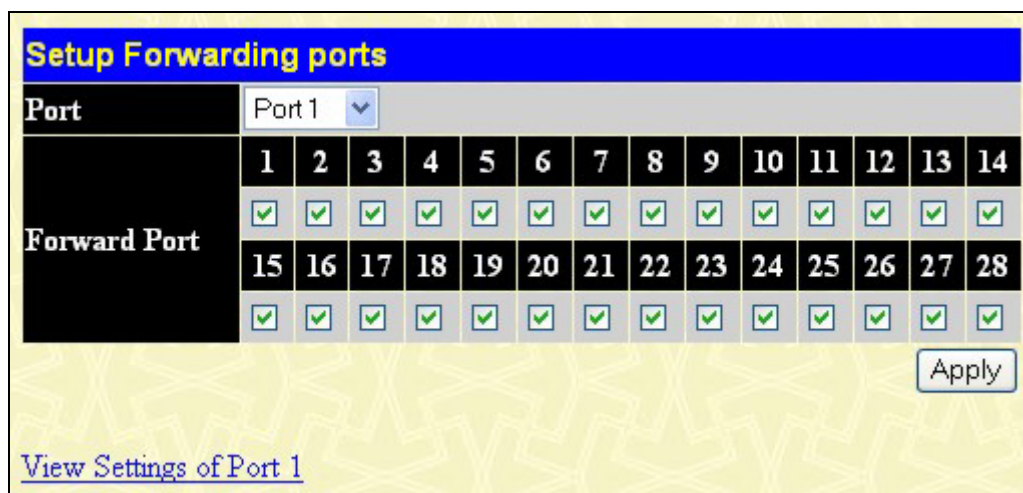

Figure 11- 33. Setup Forwarding Ports window

The user may set the following parameters:

Parameter	Description
Port	Check the corresponding boxes for the port(s) to transmit packets.
Forward Port	Check the boxes to select which of the ports on the Switch will be able to forward packets. These ports will be allowed to receive packets from the port specified above.

Clicking the **Apply** button will enter the combination of transmitting port and allowed receiving ports into the Switch's **Current Traffic Segmentation Table**.

Secure Socket Layer (SSL)

Secure Sockets Layer or SSL is a security feature that will provide a secure communication path between a host and client through the use of authentication, digital signatures and encryption. These security functions are implemented through the use of a *ciphersuite*, which is a security string that determines the exact cryptographic parameters, specific encryption algorithms and key sizes to be used for an authentication session and consists of three levels:

1. **Key Exchange:** The first part of the cyphersuite string specifies the public key algorithm to be used. This switch utilizes the Rivest Shamir Adleman (RSA) public key algorithm and the Digital Signature Algorithm (DSA), specified here as the *DHE DSS* Diffie-Hellman (DHE) public key algorithm. This is the first authentication process between client and host as they “exchange keys” in looking for a match and therefore authentication to be accepted to negotiate encryptions on the following level.
2. **Encryption:** The second part of the ciphersuite that includes the encryption used for encrypting the messages sent between client and host. The Switch supports two types of cryptology algorithms:
 - Stream Ciphers – There are two types of stream ciphers on the Switch, *RC4 with 40-bit keys* and *RC4 with 128-bit keys*. These keys are used to encrypt messages and need to be consistent between client and host for optimal use.
 - CBC Block Ciphers – CBC refers to Cipher Block Chaining, which means that a portion of the previously encrypted block of encrypted text is used in the encryption of the current block. The Switch supports the *3DES EDE* encryption code defined by the Data Encryption Standard (DES) to create the encrypted text.
3. **Hash Algorithm:** This part of the ciphersuite allows the user to choose a message digest function which will determine a Message Authentication Code. This Message Authentication Code will be encrypted with a sent message to provide integrity and prevent against replay attacks. The Switch supports two hash algorithms, *MD5* (Message Digest 5) and *SHA* (Secure Hash Algorithm).

These three parameters are uniquely assembled in four choices on the Switch to create a three-layered encryption code for secure communication between the server and the host. The user may implement any one or combination of the ciphersuites available, yet different ciphersuites will affect the security level and the performance of the secured connection. The information included in the ciphersuites is not included with the Switch and requires downloading from a third source in a file form called a *certificate*. This function of the Switch cannot be executed without the presence and implementation of the certificate file and can be downloaded to the Switch by utilizing a TFTP server. The Switch supports SSLv3 and TLSv1. Other versions of SSL may not be compatible with this Switch and may cause problems upon authentication and transfer of messages from client to host.

Download Certificate

This window is used to download a certificate file for the SSL function on the Switch from a TFTP server. The certificate file is a data record used for authenticating devices on the network. It contains information on the owner, keys for authentication and digital signatures. Both the server and the client must have consistent certificate files for optimal use of the SSL function. The Switch only supports certificate files with .der file extensions. The Switch is shipped with a certificate pre-loaded though the user may need to download more, depending on user circumstances.

Ciphersuite

This window will allow the user to enable SSL on the Switch and implement any one or combination of listed ciphersuites on the Switch. A *ciphersuite* is a security string that determines the exact cryptographic parameters, specific encryption algorithms and key sizes to be used for an authentication session. The Switch possesses four possible ciphersuites for the SSL function, which are all enabled by default. To utilize a particular ciphersuite, disable the unwanted ciphersuites, leaving the desired one for authentication.

When the SSL function has been enabled, the web will become disabled. To manage the Switch through the web based management while utilizing the SSL function, the web browser must support SSL encryption and the header of the URL must begin with https://. (Ex. https://10.90.90.90) Any other method will result in an error and no access can be authorized for the web-based management.

To view the windows for **Download Certificate** and **Ciphersuite**, click **Security > SSL**:

Figure 11- 34. Download Certificate and Ciphersuite window

To download certificates, set the following parameters and click **Apply**.

Parameter	Description
Certificate Type	Enter the type of certificate to be downloaded. This type refers to the server responsible for issuing certificates. This field has been limited to <i>local</i> for this firmware release.
Server IP	Enter the IP address of the TFTP server where the certificate files are located.
Certificate File Name	Enter the path and the filename of the certificate file to download. This file must have a .der extension. (Ex. c:/cert.der)
Key File Name	Enter the path and the filename of the key file to download. This file must have a .der extension (Ex. c:/pkey.der)

To set up the SSL function on the Switch, configure the following parameters and click **Apply**.

Parameter	Description
Configuration	
SSL Status	Use the pull down menu to enable or disable the SSL status on the switch. The default is <i>Disabled</i> .
Cache Timeout (60-86400)	This field will set the time between a new key exchange between a client and a host using the SSL function. A new SSL session is established every time the client and host go through a key exchange. Specifying a longer timeout will allow the SSL session to reuse the master key on future connections with that particular host, therefore speeding up the negotiation process. The default setting is 600 seconds.
Ciphersuite	
RSA with RC4 128 MD5	This ciphersuite combines the RSA key exchange, stream cipher RC4 encryption with 128-bit keys and the MD5 Hash Algorithm. Use the pull down menu to enable or disable this ciphersuite. This field is <i>Enabled</i> by default.
RSA with 3DES EDE CBC SHA	This ciphersuite combines the RSA key exchange, CBC Block Cipher 3DES_EDE encryption and the SHA Hash Algorithm. Use the pull down menu to enable or disable this ciphersuite. This field is <i>Enabled</i> by default.

DHS DSS with 3DES EDE CBC SHA	This ciphersuite combines the DSA Diffie Hellman key exchange, CBC Block Cipher 3DES_EDE encryption and SHA Hash Algorithm. Use the pull down menu to enable or disable this ciphersuite. This field is <i>Enabled</i> by default.
RSA EXPORT with RC4 40 MD5	This ciphersuite combines the RSA Export key exchange and stream cipher RC4 encryption with 40-bit keys. Use the pull down menu to enable or disable this ciphersuite. This field is <i>Enabled</i> by default.



NOTE: Certain implementations concerning the function and configuration of SSL are not available on the web-based management of this Switch and need to be configured using the command line interface. For more information on SSL and its functions, see the xStack DES-3800 Series CLI Manual, located on the documentation CD of this product.



NOTE: Enabling the SSL command will disable the web-based switch management. To log on to the Switch again, the header of the URL must begin with `https://`. Entering anything else into the address field of the web browser will result in an error and no authentication will be granted.

SSH

SSH is an abbreviation of Secure Shell, which is a program allowing secure remote login and secure network services over an insecure network. It allows a secure login to remote host computers, a safe method of executing commands on a remote end node, and will provide secure encrypted and authenticated communication between two non-trusted hosts. SSH, with its array of unmatched security features is an essential tool in today's networking environment. It is a powerful guardian against numerous existing security hazards that now threaten network communications.

The steps required to use the SSH protocol for secure communication between a remote PC (the SSH client) and the Switch (the SSH server) are as follows:

1. Create a user account with admin-level access using the User Accounts window in the **Security Management** folder. This is identical to creating any other admin-level User Account on the Switch, including specifying a password. This password is used to logon to the Switch, once a secure communication path has been established using the SSH protocol.
2. Configure the User Account to use a specified authorization method to identify users that are allowed to establish SSH connections with the Switch using the **SSH User Authentication** window. There are three choices as to the method SSH will use to authorize the user, which are *Host Based*, *Password* and *Public Key*.
3. Configure the encryption algorithm that SSH will use to encrypt and decrypt messages sent between the SSH client and the SSH server, using the **SSH Algorithm** window.
4. Finally, enable SSH on the Switch using the **SSH Configuration** window.

After completing the preceding steps, a SSH Client on a remote PC can be configured to manage the Switch using a secure, in band connection.

SSH Server Configuration

The following window is used to configure and view settings for the SSH server and can be opened by clicking **Security > SSH > SSH Server Configuration**:

SSH Server Configuration	
SSH Server Status	Disabled
Max Session	8
Connection TimeOut	300
Auth. Fail	2
Session Rekeying	Never

SSH Server Configuration Settings	
SSH Server Status	Disabled <input type="button" value="v"/>
Max Session(1-8)	8 <input type="text"/>
Connection TimeOut(120-600)	300 <input type="text"/>
Auth. Fail(2-20)	2 <input type="text"/>
Session Rekeying	Never <input type="button" value="v"/>

Figure 11- 35. SSH Server Configuration Settings

To configure the SSH server on the Switch, modify the following parameters and click **Apply**:

Parameter	Description
SSH Server Status	Use the pull-down menu to enable or disable SSH on the Switch. The default is <i>Disabled</i> .
Max Session (1-8)	Enter a value between 1 and 8 to set the number of users that may simultaneously access the Switch. The default setting is 8.
Time Out (120-600)	Allows the user to set the connection timeout. The use may set a time between 120 and 600 seconds. The default setting is 300 seconds.
Auth. Fail (2-20)	Allows the Administrator to set the maximum number of attempts that a user may try to log on to the SSH Server utilizing the SSH authentication. After the maximum number of attempts has been exceeded, the Switch will be disconnected and the user must reconnect to the Switch to attempt another login. The number of maximum attempts may be set between 2 and 20. The default setting is 2.
Session Rekeying	Using the pull-down menu uses this field to set the time period that the Switch will change the security shell encryptions. The available options are <i>Never</i> , <i>10 min</i> , <i>30 min</i> , and <i>60 min</i> . The default setting is <i>Never</i> .

SSH Authentication Mode and Algorithm Settings

The SSH Algorithm window allows the configuration of the desired types of SSH algorithms used for authentication encryption. There are four categories of algorithms listed and specific algorithms of each may be enabled or disabled by using their corresponding pull-down menus. All algorithms are enabled by default. To open the following window, click **Security > SSH > SSH Authentication Mode and Algorithm Settings**:

SSH Authentication Mode and Algorithm Settings	
Password	Enabled ▾
Publickey	Enabled ▾
Host-based	Enabled ▾
Encryption Algorithm	
3DES-CBC	Enabled ▾
Blow-fish-CBC	Enabled ▾
AES128-CBC	Enabled ▾
AES192-CBC	Enabled ▾
AES256-CBC	Enabled ▾
ARC4	Enabled ▾
Cast128-CBC	Enabled ▾
Twofish128	Enabled ▾
Twofish192	Enabled ▾
Twofish256	Enabled ▾
Data Integrity Algorithm	
HMAC-SHA1	Enabled ▾
HMAC-MD5	Enabled ▾
Public Key Algorithm	
HMAC-RSA	Enabled ▾
HMAC-DSA	Enabled ▾
Apply	

Figure 11- 36. Encryption Algorithm window

The following algorithms may be set:

Parameter	Description
SSH Authentication Mode and Algorithm Settings	
Password	This parameter may be enabled if the administrator wishes to use a locally configured password for authentication on the Switch. The default is <i>Enabled</i> .
Public Key	This parameter may be enabled if the administrator wishes to use a public key configuration set on a SSH server, for authentication on the Switch. The default is <i>Enabled</i> .
Host-based	This parameter may be enabled if the administrator wishes to use a host computer for authentication. This parameter is intended for Linux users requiring SSH authentication techniques and the host computer is running the Linux operating system with a SSH program previously installed. The default is <i>Enabled</i> .
Encryption Algorithm	
3DES-CBC	Use the pull-down to enable or disable the Triple Data Encryption Standard encryption algorithm with Cipher Block Chaining. The default is <i>Enabled</i> .
Blow-fish CBC	Use the pull-down to enable or disable the Blowfish encryption algorithm with Cipher Block Chaining. The default is <i>Enabled</i> .
AES128-CBC	Use the pull-down to enable or disable the Advanced Encryption Standard AES128 encryption algorithm with Cipher Block Chaining. The default is <i>Enabled</i> .
AES192-CBC	Use the pull-down to enable or disable the Advanced Encryption Standard AES192 encryption algorithm with Cipher Block Chaining. The default is <i>Enabled</i> .
AES256-CBC	Use the pull-down to enable or disable the Advanced Encryption Standard AES-256 encryption algorithm with Cipher Block Chaining. The default is <i>Enabled</i> .
ARC4	Use the pull-down to enable or disable the Arcfour encryption algorithm with Cipher Block Chaining. The default is <i>Enabled</i> .
Cast128-CBC	Use the pull-down to enable or disable the Cast128 encryption algorithm with Cipher Block Chaining. The default is <i>Enabled</i> .
Twofish128	Use the pull-down to enable or disable the twofish128 encryption algorithm. The default is <i>Enabled</i> .
Twofish192	Use the pull-down to enable or disable the twofish192 encryption algorithm. The default is <i>Enabled</i> .
Twofish256	Use the pull-down to enable or disable the twofish256 encryption algorithm. The default is <i>Enabled</i> .
Data Integrity Algorithm	
HMAC-SHA1	Use the pull-down to enable or disable the HMAC (Hash for Message Authentication Code) mechanism utilizing the Secure Hash algorithm. The default is <i>Enabled</i> .
HMAC-MD5	Use the pull-down to enable or disable the HMAC (Hash for Message Authentication Code) mechanism utilizing the MD5 Message Digest encryption algorithm. The default is <i>Enabled</i> .
Public Key Algorithm	
HMAC-RSA	Use the pull-down to enable or disable the HMAC (Hash for Message Authentication Code) mechanism utilizing the RSA encryption algorithm. The default is <i>Enabled</i> .
HMAC-DSA	Use the pull-down to enable or disable the HMAC (Hash for Message Authentication Code) mechanism utilizing the Digital Signature Algorithm encryption. The default is <i>Enabled</i> .

Click **Apply** to implement changes made.

SSH User Authentication

The following windows are used to configure parameters for users attempting to access the Switch through SSH. To access the following window, click **Security > SSH > SSH User Authentication Mode**.

(Note: Maximum of 8 entries.)

SSH User Authentication Mode			
User Name	Auth. Mode	Host Name	Host IP
admin	Password		
user	Password		

Figure 11- 37. Current Accounts window

In the example screen to the right, the User Account “admin” has been previously set using the User Accounts window in the **Security Management** folder. A User Account MUST be set in order to set the parameters for the SSH user. To configure the parameters for a SSH user, click on the hyperlinked User Name in the **Current Accounts** window, which will reveal the following window to configure.

User Name	Darren
Auth. Mode	Password <input type="button" value="v"/>
Host Name	<input type="text"/>
Host IP	<input type="checkbox"/> 0.0.0.0 <input type="text"/>

[Show All User Authentication Entries](#)

Figure 11- 38. SSH User window

The user may set the following parameters:

Parameter	Description
User Name	Enter a User Name of no more than 15 characters to identify the SSH user. This User Name must be a previously configured user account on the Switch.
Auth. Mode	<p>The administrator may choose one of the following to set the authorization for users attempting to access the Switch.</p> <p><i>Host Based</i> – This parameter should be chosen if the administrator wishes to use a remote SSH server for authentication purposes. Choosing this parameter requires the user to input the following information to identify the SSH user.</p> <ul style="list-style-type: none"> <i>Host Name</i> – Enter an alphanumeric string of no more than 31 characters to identify the remote SSH user. <i>Host IP</i> – Enter the corresponding IP address of the SSH user. <p><i>Password</i> – This parameter should be chosen if the administrator wishes to use an administrator-defined password for authentication. Upon entry of this parameter, the Switch will prompt the administrator for a password, and then to re-type the password for confirmation.</p> <p><i>Public Key</i> – This parameter should be chosen if the administrator wishes to use the public key on a SSH server for authentication.</p>
Host Name	Enter an alphanumeric string of no more than 32 characters to identify the remote SSH user. This parameter is only used in conjunction with the Host Based choice in the Auth. Mode field.
Host IP	Enter the corresponding IP address of the SSH user. This parameter is only used in conjunction with the Host Based choice in the Auth. Mode field.

Click **Apply** to implement changes made.



NOTE: To set the SSH User Authentication parameters on the Switch, a User Account must be previously configured. For more information on configuring local User Accounts on the Switch, see the User Accounts section of this manual located in the Administration section.

IP-MAC Binding

The IP network layer uses a four-byte address. The Ethernet link layer uses a six-byte MAC address. Binding these two address types together allows the transmission of data between the layers. The primary purpose of IP-MAC binding is to restrict the access to a switch to a number of authorized users. Only the authorized client can access the Switch's port by checking the pair of IP-MAC addresses with the pre-configured database. If an unauthorized user tries to access an IP-MAC binding enabled port, the system will block the access by dropping its packet. The maximum number of IP-MAC binding entries is dependant on chip capability (e.g. the ARP table size) and storage size of the device. The maximum number of IP-MAC Binding entries is 500. The creation of authorized users can be manually configured by CLI or Web. The function is port-based, this means a user can enable or disable the function on the individual port.

IP-MAC Binding Port

To enable or disable IP-MAC binding on specific ports, click **Security > IP - MAC Binding > IP -MAC Binding Port** to open the **IP-MAC Binding Ports Setting** window. Select a port or a range of ports with the **From** and **To** fields. Enable or disable the port with the **State** field. Click **Apply** to save changes.

IP-MAC Binding Ports Setting			
From	To	State	Apply
Port 1	Port 1	Disabled	Apply

IP-MAC Binding Port State Table			
Port	State	Port	State
1	Disabled	15	Disabled
2	Disabled	16	Disabled
3	Disabled	17	Disabled
4	Disabled	18	Disabled
5	Disabled	19	Disabled
6	Disabled	20	Disabled
7	Disabled	21	Disabled
8	Disabled	22	Disabled
9	Disabled	23	Disabled
10	Disabled	24	Disabled
11	Disabled	25	Disabled
12	Disabled	26	Disabled
13	Disabled	27	Disabled
14	Disabled	28	Disabled

Figure 11- 39. IP-MAC Binding Ports window

IP-MAC Binding Table

The window shown below can be used to create IP-MAC binding entries. Click the **IP-MAC Binding Table** on the **IP-MAC Binding** folder in the **Security** menu to view the **IP-MAC Binding Setting** window. Enter the IP and MAC addresses of the authorized users in the appropriate fields and click **Add**. To modify either the IP address or the MAC address of the binding entry, make the desired changes in the appropriate field and Click **Modify**. To find an IP-MAC binding entry, enter the IP and MAC addresses and click **Find**. To delete an entry click **Delete**. To clear all the entries from the table click **Delete All**.

IP-MAC Binding Setting	
IP Address	0.0.0.0
MAC Address	00-00-00-00-00-00
<input type="button" value="Add"/> <input type="button" value="Modify"/> <input type="button" value="Find"/> <input type="button" value="Delete All"/>	
Total Entries: 0	
IP-MAC Binding Table	
IP Address	MAC Address
	Delete

Figure 11- 40. IP-MAC Binding Table window

IP-MAC Binding Blocked

To view unauthorized devices that have been blocked by IP-MAC binding restrictions open the **IP-MAC Binding Blocked** window show below. Click **IP-MAC Binding Blocked** in the **IP-MAC Binding** folder in the **Security** menu to open the **IP-MAC Binding Blocked** window.

IP-MAC Binding Blocked

VLAN Name

MAC Address

Total Entries: 21

IP-MAC Binding Blocked Table

VID	VLAN NAME	MAC Address	Delete
1	default	00-03-09-18-10-01	✕
1	default	00-03-44-ae-bc-12	✕
1	default	00-07-e9-13-8f-50	✕
1	default	00-0c-6e-55-bc-82	✕
1	default	00-0c-f8-20-90-01	✕
1	default	00-0c-f8-41-c0-01	✕
1	default	00-0c-f8-42-40-01	✕
1	default	00-0c-f8-44-10-01	✕
1	default	00-0d-60-8f-49-38	✕
1	default	00-50-ba-10-d8-eb	✕
1	default	00-50-ba-da-01-58	✕
1	default	00-50-ba-da-02-3e	✕
1	default	00-50-ba-da-04-1f	✕
1	default	00-80-c8-2e-c7-4c	✕
1	default	00-80-c8-3b-ef-32	✕
1	default	00-80-c8-4c-69-f8	✕
1	default	00-80-c8-92-2d-58	✕
1	default	00-80-c8-92-67-9f	✕
1	default	00-e0-18-45-c7-15	✕
1	default	00-e0-18-70-b3-b4	✕

Figure 11- 41. IP-MAC Binding Blocked window

To find an unauthorized device that has been blocked by the IP-MAC binding restrictions, enter the **VLAN** name and **MAC Address** in the appropriate fields and click **Find**. To delete an entry click the ✕ next to the entry's MAC address. To delete all the entries in the **IP-MAC Binding Blocked Table** click **Delete All**.

Limited IP Multicast Range

The **Limited IP Multicast Range** window allows the user to specify which multicast address(es) reports are to be received on specified ports on the Switch. This function will therefore limit the number of reports received and the number of multicast groups configured on the Switch. The user may set an IP address or range of IP addresses to accept reports (Permit) or deny reports (Deny) coming into the specified switch ports. Click **Security > Limited IP Multicast Range Settings** to open the **Limited IP Multicast Range** window shown below:

From	To	State	From Multicast IP	To Multicast IP	Access	Apply
Port 1	Port 1	Disabled	0.0.0.0	0.0.0.0	Permit	Apply

The Port Information Table				
Port	State	From Multicast IP	To Multicast IP	Access
1	Disabled	0.0.0.0	0.0.0.0	None
2	Disabled	0.0.0.0	0.0.0.0	None
3	Disabled	0.0.0.0	0.0.0.0	None
4	Disabled	0.0.0.0	0.0.0.0	None
5	Disabled	0.0.0.0	0.0.0.0	None
6	Disabled	0.0.0.0	0.0.0.0	None
7	Disabled	0.0.0.0	0.0.0.0	None
8	Disabled	0.0.0.0	0.0.0.0	None
9	Disabled	0.0.0.0	0.0.0.0	None
10	Disabled	0.0.0.0	0.0.0.0	None
11	Disabled	0.0.0.0	0.0.0.0	None
12	Disabled	0.0.0.0	0.0.0.0	None
13	Disabled	0.0.0.0	0.0.0.0	None
14	Disabled	0.0.0.0	0.0.0.0	None
15	Disabled	0.0.0.0	0.0.0.0	None
16	Disabled	0.0.0.0	0.0.0.0	None
17	Disabled	0.0.0.0	0.0.0.0	None
18	Disabled	0.0.0.0	0.0.0.0	None
19	Disabled	0.0.0.0	0.0.0.0	None
20	Disabled	0.0.0.0	0.0.0.0	None
21	Disabled	0.0.0.0	0.0.0.0	None
22	Disabled	0.0.0.0	0.0.0.0	None
23	Disabled	0.0.0.0	0.0.0.0	None
24	Disabled	0.0.0.0	0.0.0.0	None
25	Disabled	0.0.0.0	0.0.0.0	None
26	Disabled	0.0.0.0	0.0.0.0	None
27	Disabled	0.0.0.0	0.0.0.0	None
28	Disabled	0.0.0.0	0.0.0.0	None

Figure 11- 42. Limited IP Multicast Range

To configure **Limited IP Multicast Range**:

1. Choose the port or sequential range of ports using the From...To... port pull-down menus.
2. Use the remaining pull-down menus to configure the parameters described below:

Parameter	Description
State	Toggle the State field to either <i>Enabled</i> or <i>Disabled</i> for a given port or group of ports where access is to be either permitted or denied.
From Multicast IP	Enter the lowest multicast IP address of the range.
To Multicast IP	Enter the highest multicast IP address of the range.
Access	Toggle the Access field to either <i>Permit</i> or <i>Deny</i> to limit or grant access to a specified range of Multicast addresses on a particular port or range of ports.

Click **Apply** to implement the new settings on the Switch.

Web-based Access Control

Web-based Access Control is another port based access control method implemented similarly to the 802.1x port based access control method previously stated. This function will allow user authentication through a RADIUS server or through the local authentication set on the Switch when a user is trying to access the network via the switch, if the port connected to the user is enabled for this feature.

The user attempting to gain web access will be prompted for a username and password before being allowed to accept HTTP packets from the Switch. When a client attempts to access a website, that port is placed in the authentication VLAN set by the user. All clients in this authentication VLAN will be queried for authentication by the local method or through a RADIUS server. Once accepted, the user will be placed in a target VLAN on the Switch where it will have rights and privileges to openly access the Internet. If denied access, no packets will pass through to the user and thus, that user will be returned to the authentication VLAN from where it came and the authentication procedure will have to be reattempted by the user.

Once a client has been authenticated on a particular port, that port will be placed in the pre-configured VLAN and any other clients on that port will be automatically authenticated to access the specified Redirection Path URL, as well as the authenticated client.

To the right there is an example of the basic six step process all parties of the authentication go through for a successful Web-based Access Control process.

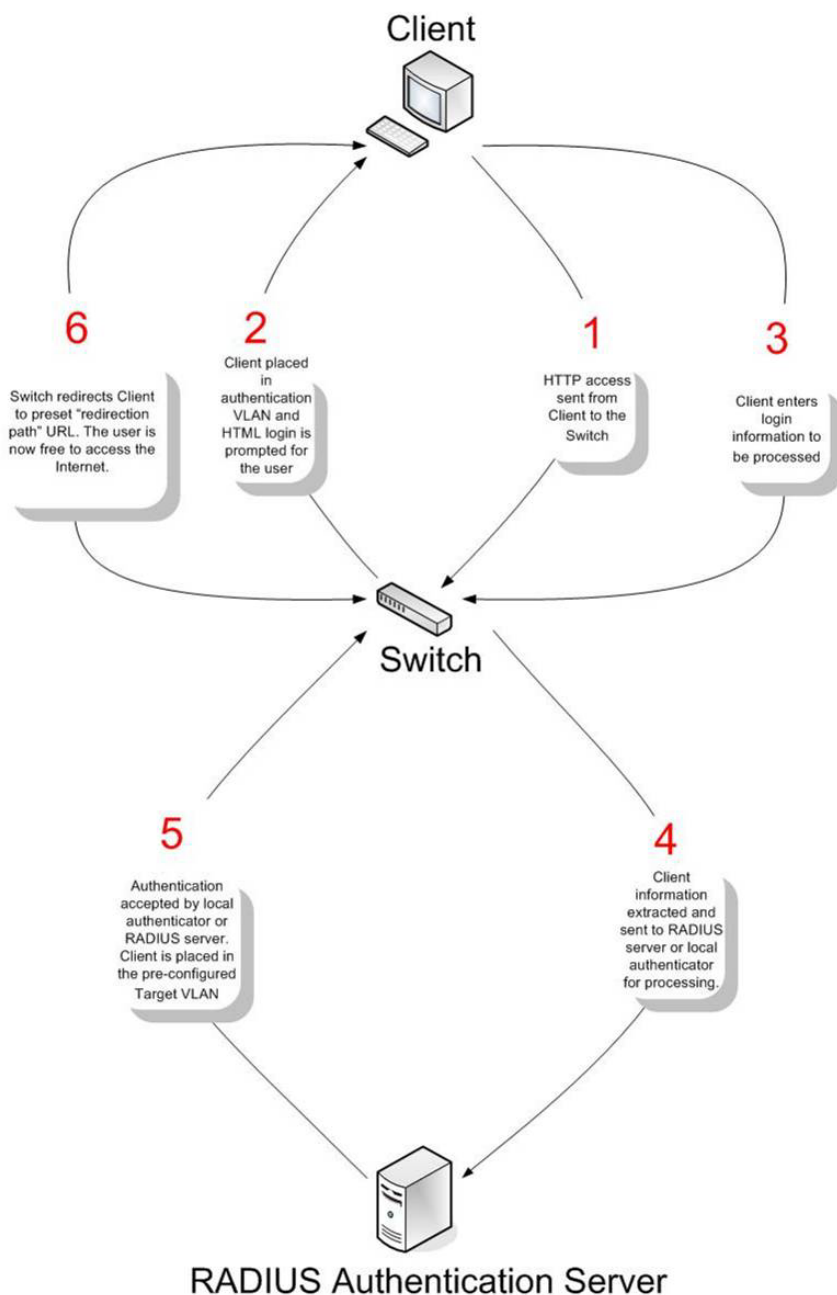

Conditions and Limitations

1. The subnet of the authentication VLAN's IP interface must be the same as that of the client. If not configured properly, the authentication will be permanently denied by the authenticator.
2. If the client is utilizing DHCP to attain an IP address, the authentication VLAN must provide a DHCP server or a DHCP relay function so that client may obtain an IP address.
3. The authentication VLAN of this function must be configured to access a DNS server to improve CPU performance, and allow the processing of DNS, UDP and HTTP packets.
4. Certain functions exist on the Switch that will filter HTTP packets, such as the Access Profile function. The user needs to be very careful when setting filter functions for the target VLAN, so that these HTTP packets are not denied by the Switch.
5. The Redirection Path must be set before the Web-based Access Control can be enabled. If not, the user will be prompted with an error message and the Web-based Access Control will not be enabled.
6. If a RADIUS server is to be used for authentication, the user must first establish a RADIUS Server with the appropriate parameters, including the target VLAN, before enabling the Web-based Access Control on the Switch.

To configure the Switch for WAC Configuration, first open the **Security** folder and click **WAC Configuration**, which will open the following screen.

Figure 11- 43. Web-based Access Control Configuration window

To set the Web-based Access Control for the Switch, complete the following fields:

Parameter	Description
Web-based Access Control State	Toggle the State field to either <i>Enable</i> or <i>Disable</i> for the Web-based Access Control settings of the Switch.
VLAN Name	Enter the VLAN name which users will be placed while authenticated by the Switch or a RADIUS server. This VLAN should be pre-configured to have limited access rights to web based authenticated users.
Method	Use the pull down menu to choose the authenticator for Web-based Access Control. The user may choose: <i>local</i> – Choose this parameter to use the local authentication method of the Switch as the authenticating method for users trying to access the network via the switch. This is, in fact, the username and password to access the Switch configured using the User Account Creation screen seen below. <i>radius</i> – Choose this parameter to use a remote RADIUS server as the authenticating method for users trying to access the network via the switch. This RADIUS server must have already been pre-assigned by the administrator using the RADIUS Server window located in the 802.1x section.
Port List	Specify the ports to be enabled as Web-based Access Control ports. Only these ports will accept authentication parameters from the user wishing limited access rights through the Switch. When one client on a port has been authenticated for Web-based Access Control, all clients on this port are authenticated as well. Use the State pull down menu to enable these configured ports as Web-based Access Control ports.
Redirection Page	Enter the URL of the website that authenticated users placed in the VLAN are directed to once authenticated. This path must be entered into this field before the Web-based Access Control can be enabled.

Click **Apply** to implement changes made.



NOTE: To enable the Web-based Access Control function, the redirection path field must have the URL of the website that users will be directed to once they enter the limited resource, pre-configured VLAN. Users which attempt Apply settings without the Redirection Page field set will be prompted with an error message and Web-based Access Control will not be enabled. The URL should follow the form http(s)://www.dlink.com



NOTE: The subnet of the IP address of the authentication VLAN must be the same as that of the client, or the client will always be denied authentication.



NOTE: A successful authentication should direct the client to the stated web page. If the client does not reach this web page, yet does not receive a **Fail!** message, the client will already be authenticated and therefore should refresh the current browser window or attempt to open a different web page.

To view Web-based Access Control status of individual ports, click the [Show port state](#) link to open the window seen below.

From: Port 1 ▼ To: Port 1 ▼

Web-based Access Control Port State		
Port	State	Auth. Status
1	Disable	Unauth
2	Disable	Unauth
3	Disable	Unauth
4	Disable	Unauth
5	Disable	Unauth
6	Disable	Unauth
7	Disable	Unauth
8	Disable	Unauth
9	Disable	Unauth
10	Disable	Unauth

Figure 11- 44. Web-based Access Control Port State window

Use the pull-down menu in the **From** and **To** fields to select a port or range of ports to be viewed for their Web-based Access Control status. In the previous window, ports 1-10 have been selected to be viewed.

To set user accounts for the Web-based Access Control click **Security > User Account Management** which will open the following screen for the user to configure.

Figure 11- 45. Web-based User Account Settings window

To set the User Account settings for the Web-based Access Control by the Switch, complete the following fields.

Parameter	Description
User Account Creation	
User Name	Enter the username of up to 15 alphanumeric characters of the guest wishing to access the web through this process. This field is for administrators who have selected <i>local</i> as their web based authenticator.
Password	Enter the password the administrator has chosen for the selected user. This field is case sensitive and must be a complete alphanumeric string. This field is for administrators who have selected <i>local</i> as their web based authenticator.
User-VLAN Mapping	
User Name	Enter the user name of a guest authenticated through this process, to be mapped to a previously configured VLAN with limited rights.
VLAN Name	Enter the VLAN name of a previously configured VLAN to which successfully authenticated web user will be mapped.
Link	Click the Link button to map the user name and VLAN stated in the previous 2 fields. Users will be linked directly to the VLAN upon successful authentication.
User List	This section displays users and their associated VLAN configured for Web-based Access Control. Click the corresponding  to delete the user.

The following window displays the Authentication Login screens that guest users will be prompted with once attempting Web-based Access Control. Enter the user name and the password configured in the previous screen and click **Enter** to access the VLAN previously assigned by the Switch administrator for successful authentication.

Figure 11- 46. Web-based Access Control Authentication Login window

Safeguard Engine

Periodically, malicious hosts on the network will attack the Switch by utilizing packet flooding (ARP Storm) or other methods. These attacks may increase the Safeguard Engine beyond its capability. To alleviate this problem, the Safeguard Engine function was added to the Switch's software.

The Safeguard Engine can help the overall operability of the Switch by minimizing the workload of the Switch while the attack is ongoing, thus making it capable to forward essential packets over its network in a limited bandwidth. When the Switch either (a) receives too many packets to process or (b) exerts too much memory, it will enter an **Exhausted** mode. When in this mode, the Switch will drop all ARP and IP broadcast packets for a calculated time interval. Every five seconds, the Switch will check to see if there are too many packets flooding the Switch. If the threshold has been crossed, the Switch will initially stop all ingress ARP and IP broadcast packets for five seconds. After another five-second checking interval arrives, the Switch will again check the ingress flow of packets. If the flooding has stopped, the Switch will again begin accepting all packets. Yet, if the checking shows that there continues to be too many packets flooding the Switch, it will stop accepting all ARP and IP broadcast packets for double the time of the previous stop period. This doubling of time for stopping ingress ARP and IP broadcast packets will continue until the maximum time has been reached, which is 320 seconds and every stop from this point until a return to normal ingress flow would be 320 seconds. For a better understanding, examine the following example of the Safeguard Engine.

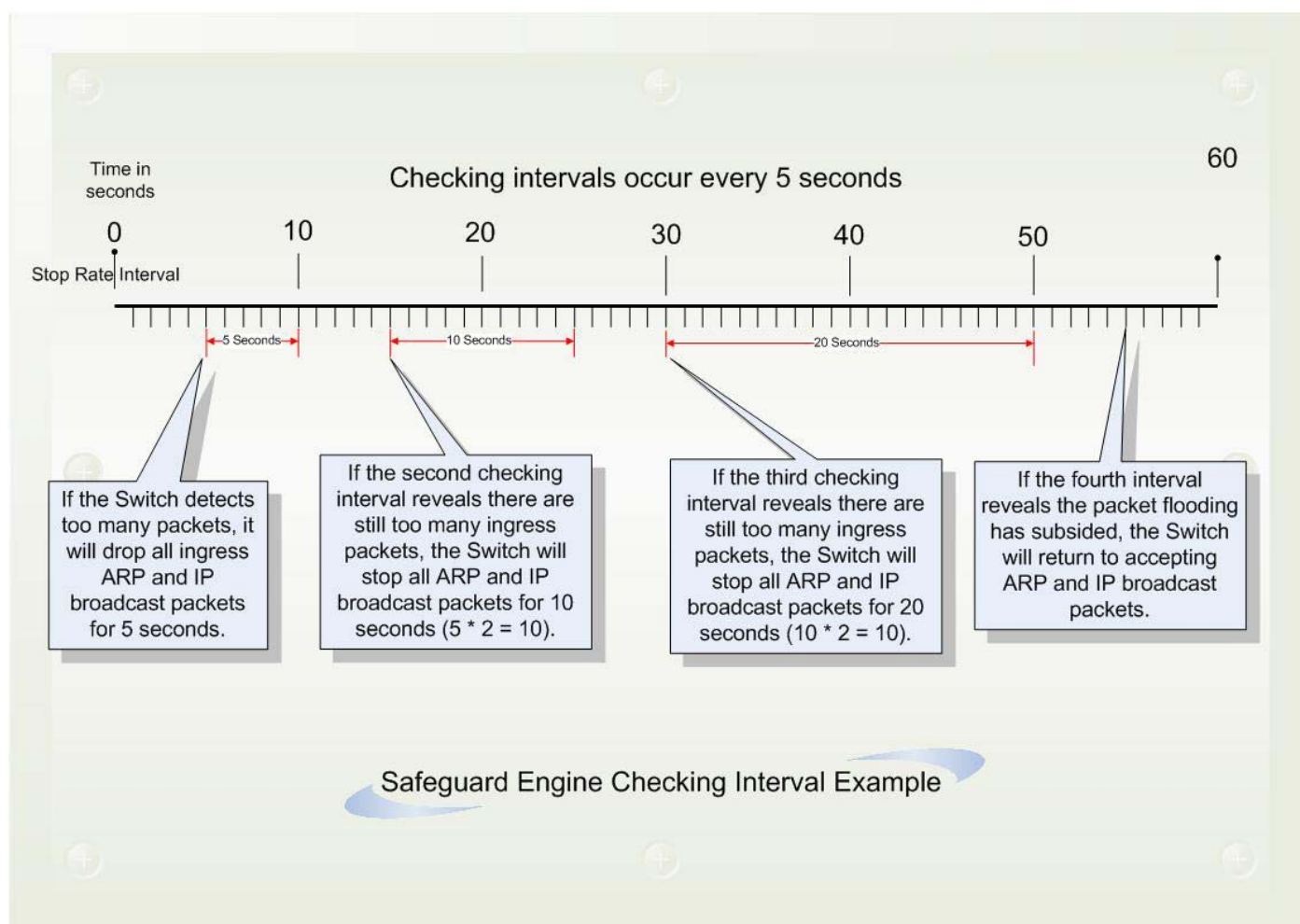

Figure 11- 47. Safeguard Engine example

For every consecutive checking interval that reveals a packet flooding issue, the Switch will double the time it will discard ingress ARP and IP broadcast packets. In the example above, the Switch doubled the time for dropping ARP and IP broadcast packets when consecutive flooding issues were detected at 5 second intervals. (First stop = 5 seconds, second stop = 10 seconds, third stop = 20 seconds) Once the flooding is no longer detected, the wait period for dropping ARP and IP broadcast packets will return to 5 seconds and the process will resume.

Once in Exhausted mode, the packet flow will decrease by half of the level that caused the Switch to enter Exhausted mode. After the packet flow has stabilized, the rate will initially increase by 25% and then return to a normal packet flow.

To configure the Safeguard Engine for the Switch, click **Security > Safeguard Engine >** which will open the following window.

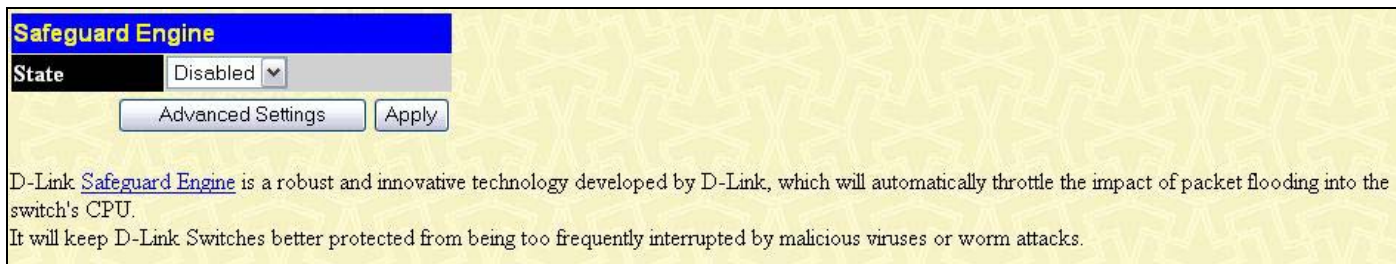

Figure 11- 48. Safeguard Engine window

To configure the Switch’s Safeguard Engine, change the **State** to *Enabled*. To configure the parameters for the Safeguard Engine, click the **Advanced Settings** button which will alter the previous screen to look like this:

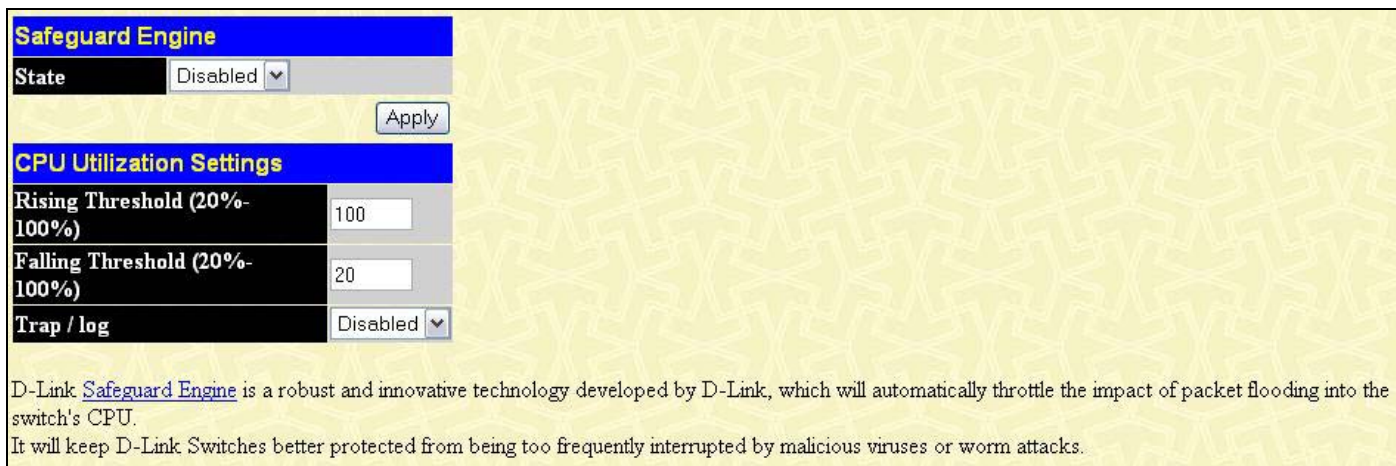

Figure 11- 49. Safeguard Engine window - Advanced Settings

To set the Safeguard Engine for the Switch, complete the following fields:

Parameter	Description
State	Toggle the State field to either <i>Enabled</i> or <i>Disabled</i> for the Safeguard Engine of the Switch.
Rising Threshold	Used to configure the acceptable level of CPU utilization before the Safeguard Engine mechanism is enabled. Once the CPU utilization reaches this percentage level, the Switch will move into the Exhausted state.
Falling Threshold	Used to configure the acceptable level of CPU utilization as a percentage, where the Switch leaves the Exhausted state and returns to normal mode.
Trap/log	Use the pull-down menu to enable or disable the sending of messages to the device’s SNMP agent and switch log once the Safeguard Engine has been activated by a high CPU utilization rate.

Section 12

Monitoring

Device Status

CPU Utilization

Safeguard Engine Status

Port Utilization

Packets

Errors

Packet Size

Browse Router Port

Port Access Control

MAC Address Table

IP Address Table

Browse Routing Table

Browse ARP Table

Browse IP Multicast Forwarding Table

IGMP Snooping Group

IGMP Snooping Forwarding

Browse IGMP Group Table

DVMRP Monitor

OSPF Monitor

Browse PoE Status

Browse WRED Settings

Switch History Log

Device Status

The Device Status window displays status information for Internal Power, External Power, Side Fan, and Back Fan.

Device Status				
ID	Internal Power	External Power	Side Fan	Back Fan
1	Active	Fail	Fail	OK

Figure 12- 1. Device Status window

CPU Utilization

The **CPU Utilization** window displays the percentage of the CPU being used, expressed as an integer percentage and calculated as a simple average by time interval. To view this window, open the **Monitoring** folder and click the **CPU Utilization** link.

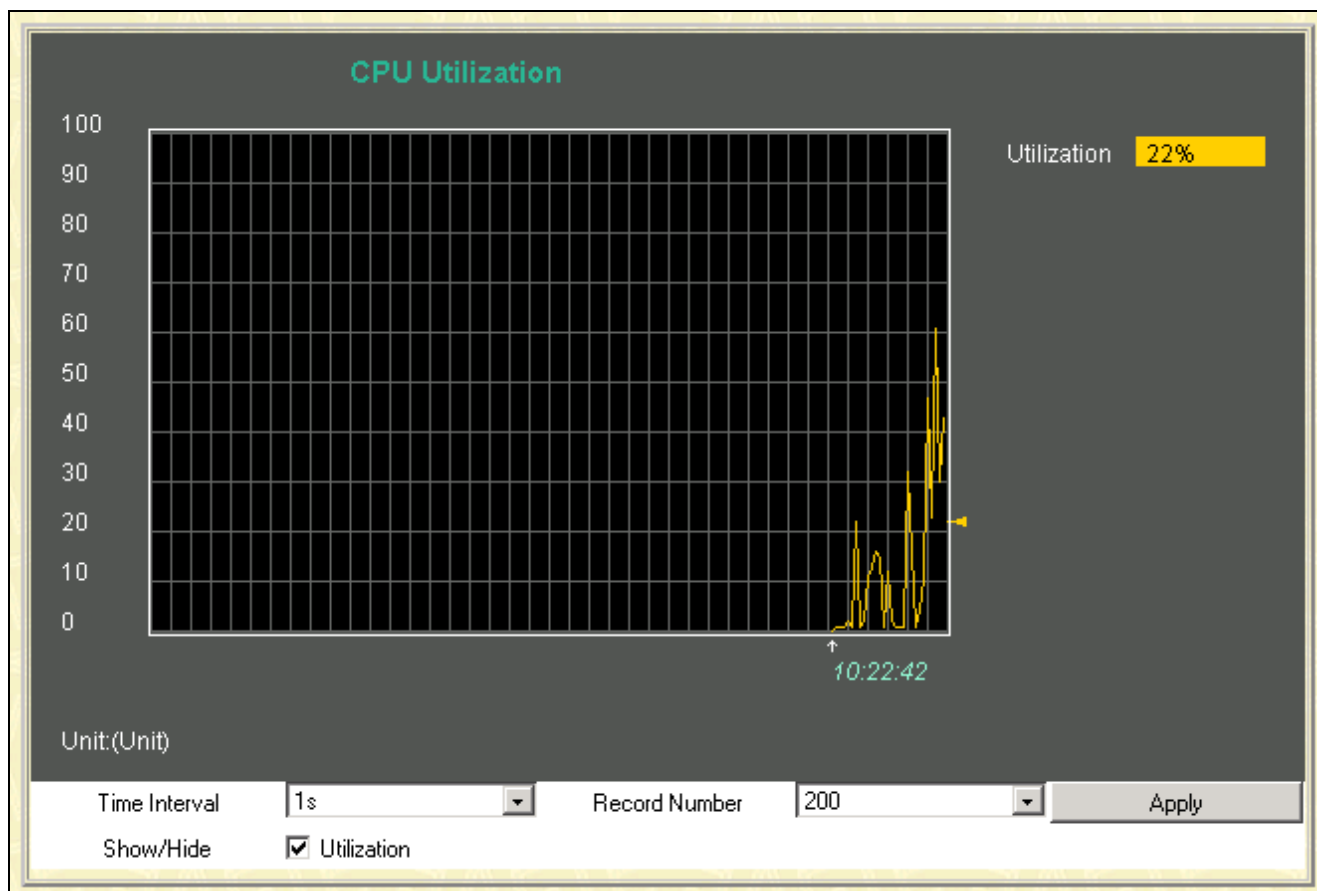

Figure 12- 2. CPU Utilization window

Click **Apply** to implement the configured settings. The window will automatically refresh with new updated statistics

The information is described as follows:

Parameter	Description
Time Interval	Select the desired setting between <i>1s</i> and <i>60s</i> , where "s" stands for seconds. The default value is one second.
Record Number	Select number of times the Switch will be polled between <i>20</i> and <i>200</i> . The default value is <i>20</i> .
Utilization	Check whether or not to display Utilization.

Safeguard Engine Status

The following window displays parameters configured for and about the **Safeguard Engine Status** currently set on the Switch.

Safeguard Engine Status	
State	Disabled
Current Status	Normal Mode
CPU Utilization Information	
Interval	5 sec
Rising Threshold (20-100)	100%
Falling Threshold (20-100)	20%
Trap / Log	Disabled

Figure 12- 3. Safeguard Engine Status and CPU Utilization Information window

The information is described as follows:

Parameter	Description
State	Displays the current running state of the Safeguard Engine, whether enabled or disabled.
Current Status	Displays the current running status of the Safeguard Engine, whether engaged or in normal mode.
Interval	Displays the time interval between the checking of the rising and falling threshold of packets entering the Switch. The default setting is 5 seconds.
Rising Threshold	Displays the set percentage of the rising threshold of packets determinant of the Safeguard Engine.
Falling Threshold	Displays the set percentage of the falling threshold of packets determinant of the Safeguard Engine.
Trap/log	Displays the status of the sending of messages to the switch's log or SNMP trap. Enabled will denote the switch will send trap messages in the event of a Safeguard Engine engagement.

Port Utilization

The **Utilization** window displays the percentage of the total available bandwidth being used on the port. To view the port utilization, open the **Monitoring** folder and then the **Port Utilization** link:

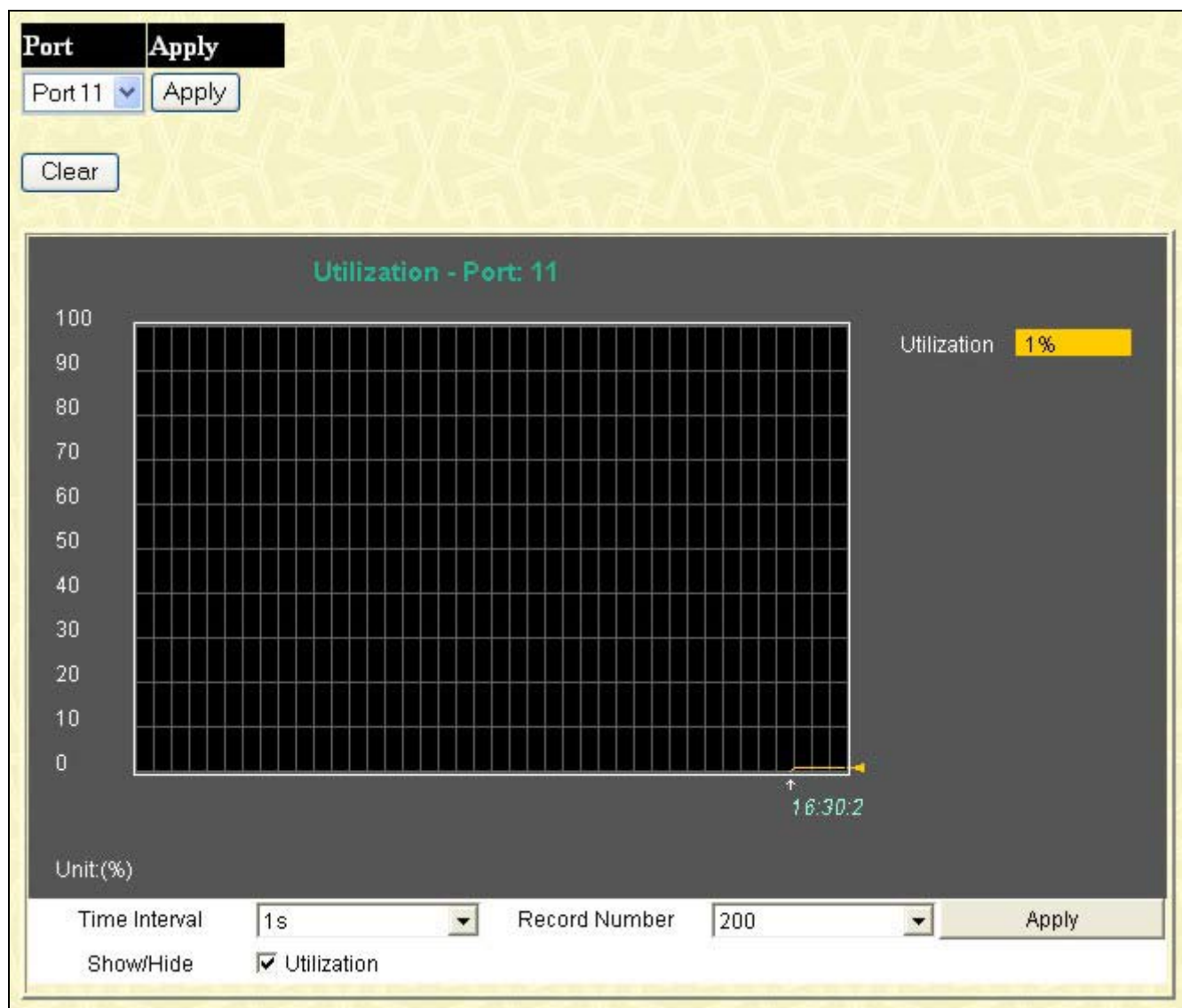

Figure 12- 4. Port Utilization window

Select a Unit and Port number from the drop down menu and click apply to display the Port Utilization for a particular port. The following fields can be set:

Parameter	Description
Time Interval	Select the desired setting between 1s and 60s, where "s" stands for seconds. The default value is one second.
Record Number	Select number of times the Switch will be polled between 20 and 200. The default value is 200.

Click **Clear** to refresh the graph. Click **Apply** to set changes implemented.

Packets

The Web Manager allows various packet statistics to be viewed as either a line graph or a table. Six windows are offered.

Received (RX)

Click the **Received (RX)** link in the **Packets** folder of the **Monitoring** menu to view the following graph of packets received on the Switch.

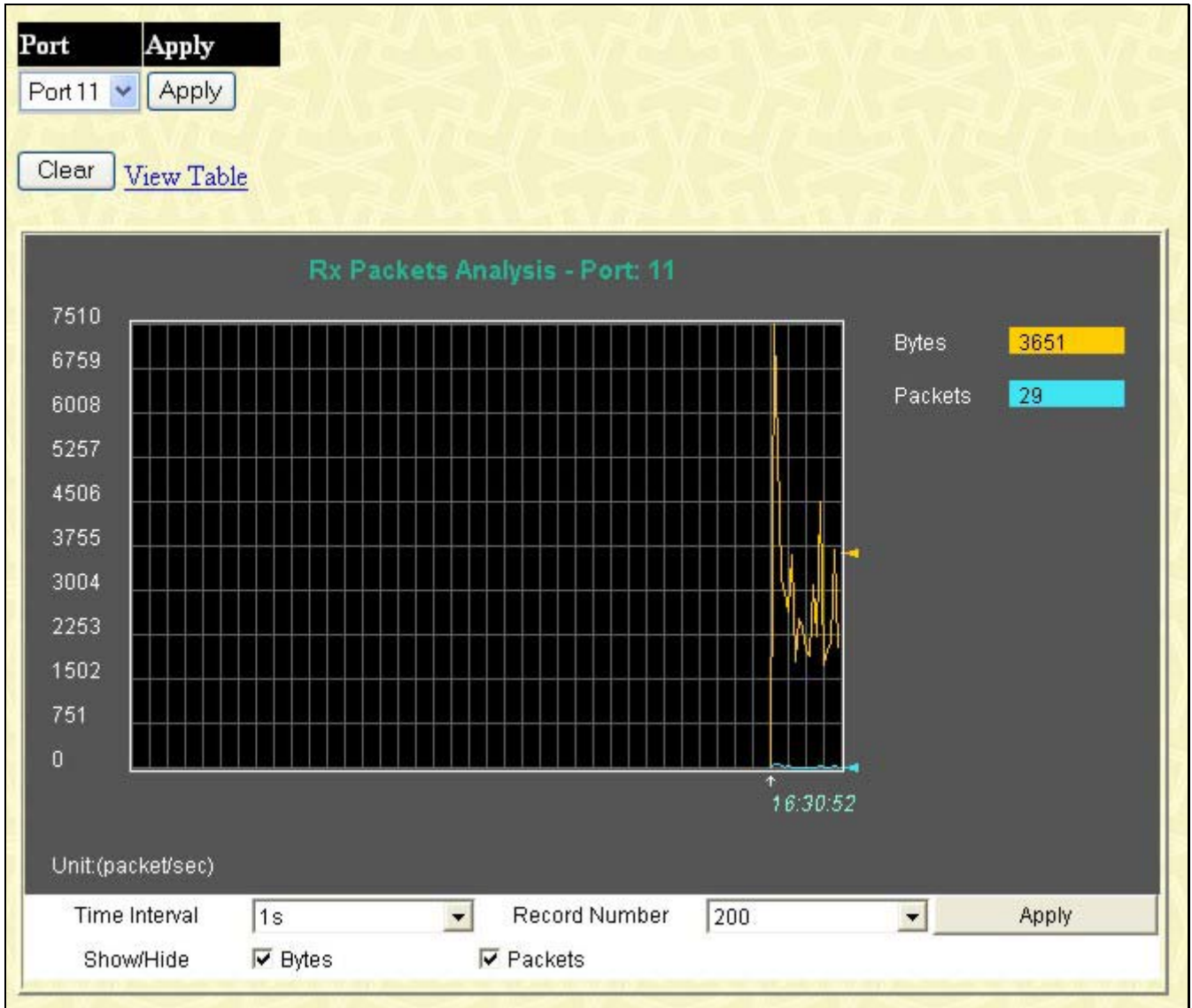

Figure 12- 5. Rx Packets Analysis window (line graph for Bytes and Packets)

Select a Port number from the drop down menu and click **Apply** to display the Rx Packet analysis for a particular port. To view the **Received Packets Table**, click the link [View Table](#), which will show the following table:

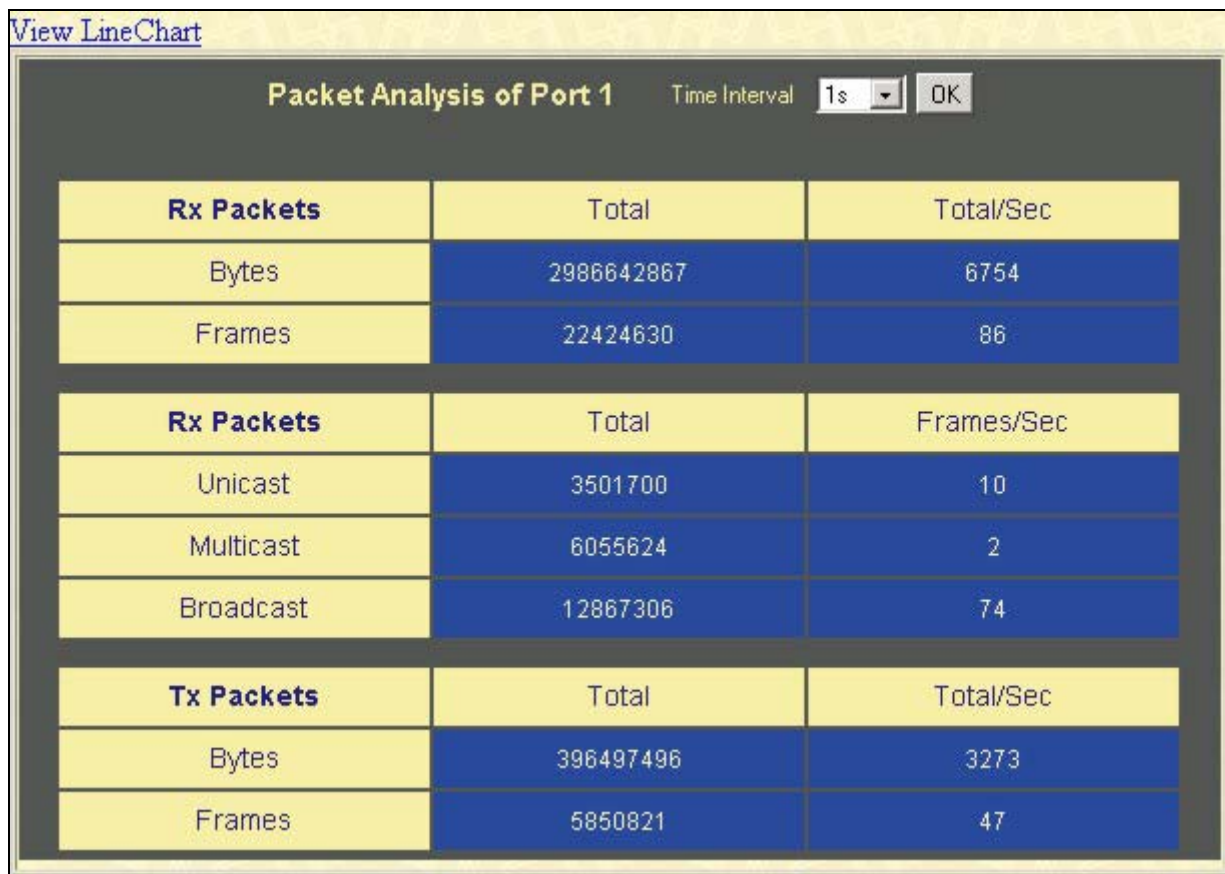

Figure 12- 6. Rx Packets Analysis window (table for Bytes and Packets)

The following fields may be set or viewed:

Parameter	Description
Time Interval	Select the desired setting between 1s and 60s, where "s" stands for seconds. The default value is one second.
Record Number	Select number of times the Switch will be polled between 20 and 200. The default value is 20.
Bytes	Counts the number of bytes received on the port.
Packets	Counts the number of packets received on the port.
Show/Hide	Check whether to display Bytes and Packets.
Clear	Clicking this button clears all statistics counters on this window.
View Table	Clicking this button instructs the Switch to display a table rather than a line graph.
View Line Chart	Clicking this button instructs the Switch to display a line graph rather than a table.

UMB Cast (RX)

Click the **UMB Cast (RX)** link in the **Packets** folder of the **Monitoring** menu to view the following graph of UMB cast packets received on the Switch.

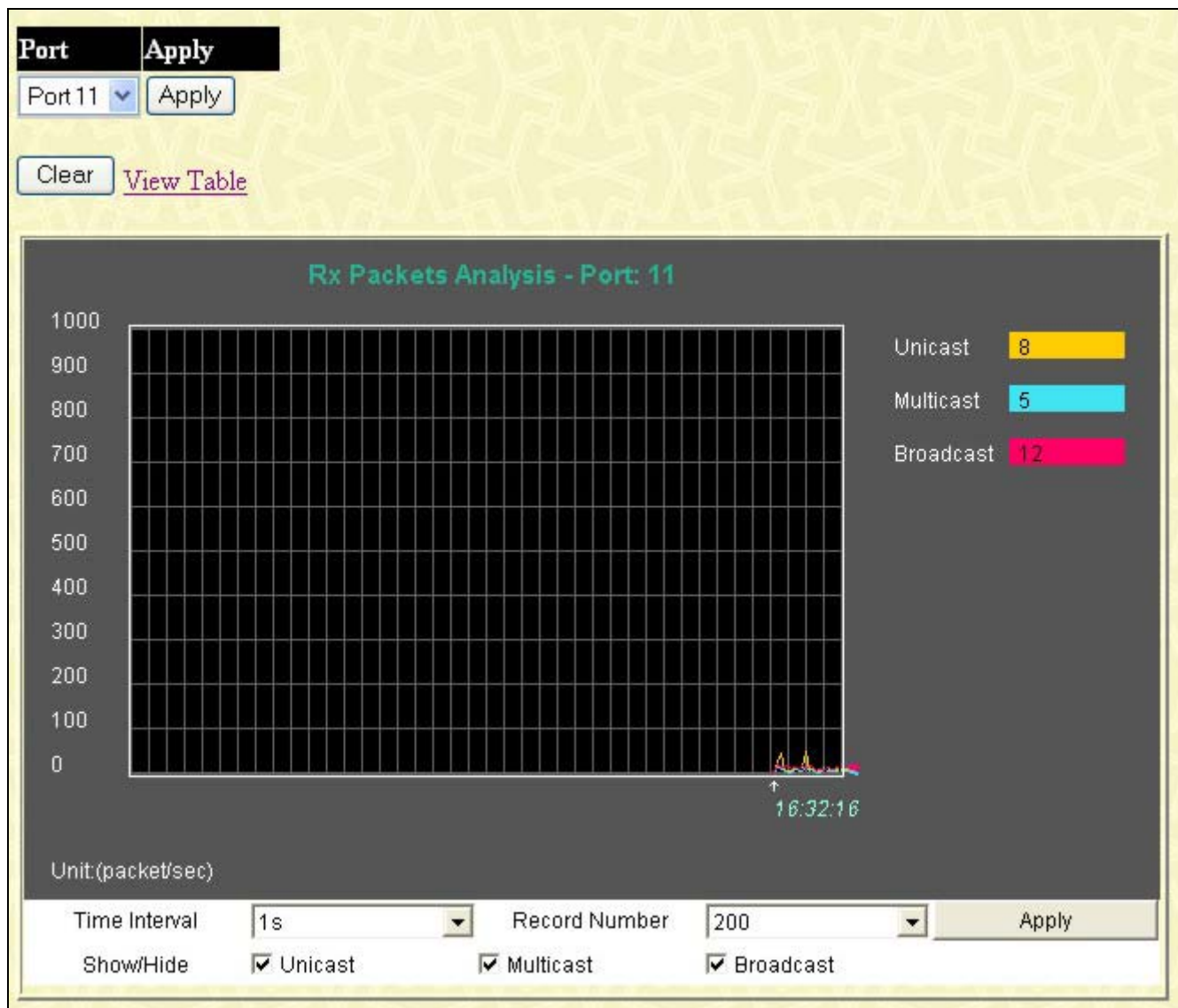

Figure 12- 7. Rx Packets Analysis window (line graph for Unicast, Multicast, and Broadcast Packets)

To view the **UMB Cast Table**, click the [View Table](#) link, which will show the following table:

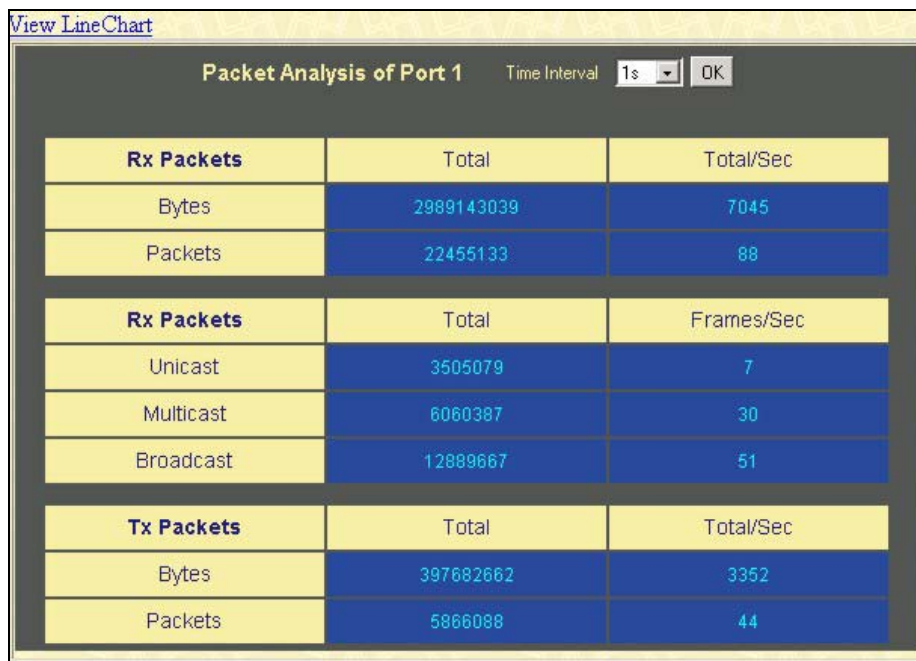

Figure 12- 8. Rx Packets Analysis window (table for Unicast, Multicast, and Broadcast Packets)

The following fields may be set or viewed:

Parameter	Description
Time Interval	Select the desired setting between 1s and 60s, where "s" stands for seconds. The default value is one second.
Record Number	Select number of times the Switch will be polled between 20 and 200. The default value is 20.
Unicast	Counts the total number of good packets that were received by a unicast address.
Multicast	Counts the total number of good packets that were received by a multicast address.
Broadcast	Counts the total number of good packets that were received by a broadcast address.
Show/Hide	Check whether or not to display Multicast, Broadcast, and Unicast Packets.
Clear	Clicking this button clears all statistics counters on this window.
View Table	Clicking this button instructs the Switch to display a table rather than a line graph.
View Line Chart	Clicking this button instructs the Switch to display a line graph rather than a table.

Transmitted (TX)

Click the **Transmitted (TX)** link in the **Packets** folder of the **Monitoring** menu to view the following graph of packets transmitted from the Switch.



Figure 12- 9. Tx Packets Analysis window (line graph for Bytes and Packets)

To view the **Transmitted (TX) Table**, click the link [View Table](#), which will show the following table:

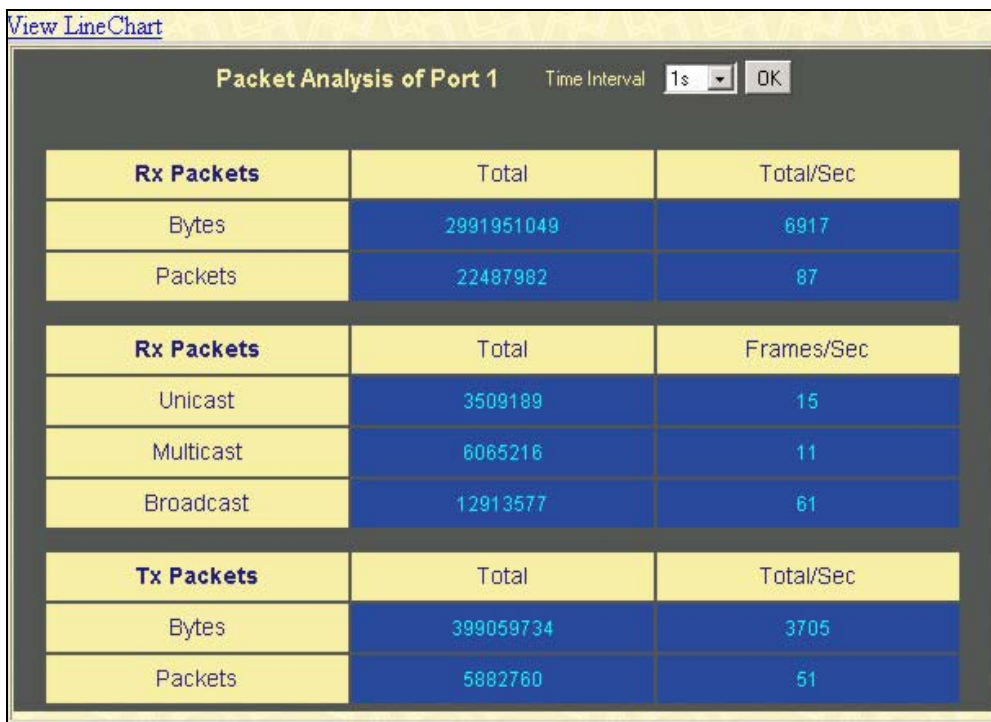

Figure 12- 10. Tx Packets Analysis window (table for Bytes and Packets)

The following fields may be set or viewed:

Parameter	Description
Time Interval	Select the desired setting between 1s and 60s, where "s" stands for seconds. The default value is one second.
Record Number	Select number of times the Switch will be polled between 20 and 200. The default value is 20.
Bytes	Counts the number of bytes successfully sent from the port.
Packets	Counts the number of packets successfully sent on the port.
Show/Hide	Check whether or not to display Bytes and Packets.
Clear	Clicking this button clears all statistics counters on this window.
View Table	Clicking this button instructs the Switch to display a table rather than a line graph.
View Line Chart	Clicking this button instructs the Switch to display a line graph rather than a table.

Errors

The Web Manager allows port error statistics compiled by the Switch's management agent to be viewed as either a line graph or a table. Four windows are offered.

Received (RX)

Click the **Received (RX)** link in the **Errors** folder of the **Monitoring** menu to view the following graph of error packets received on the Switch.

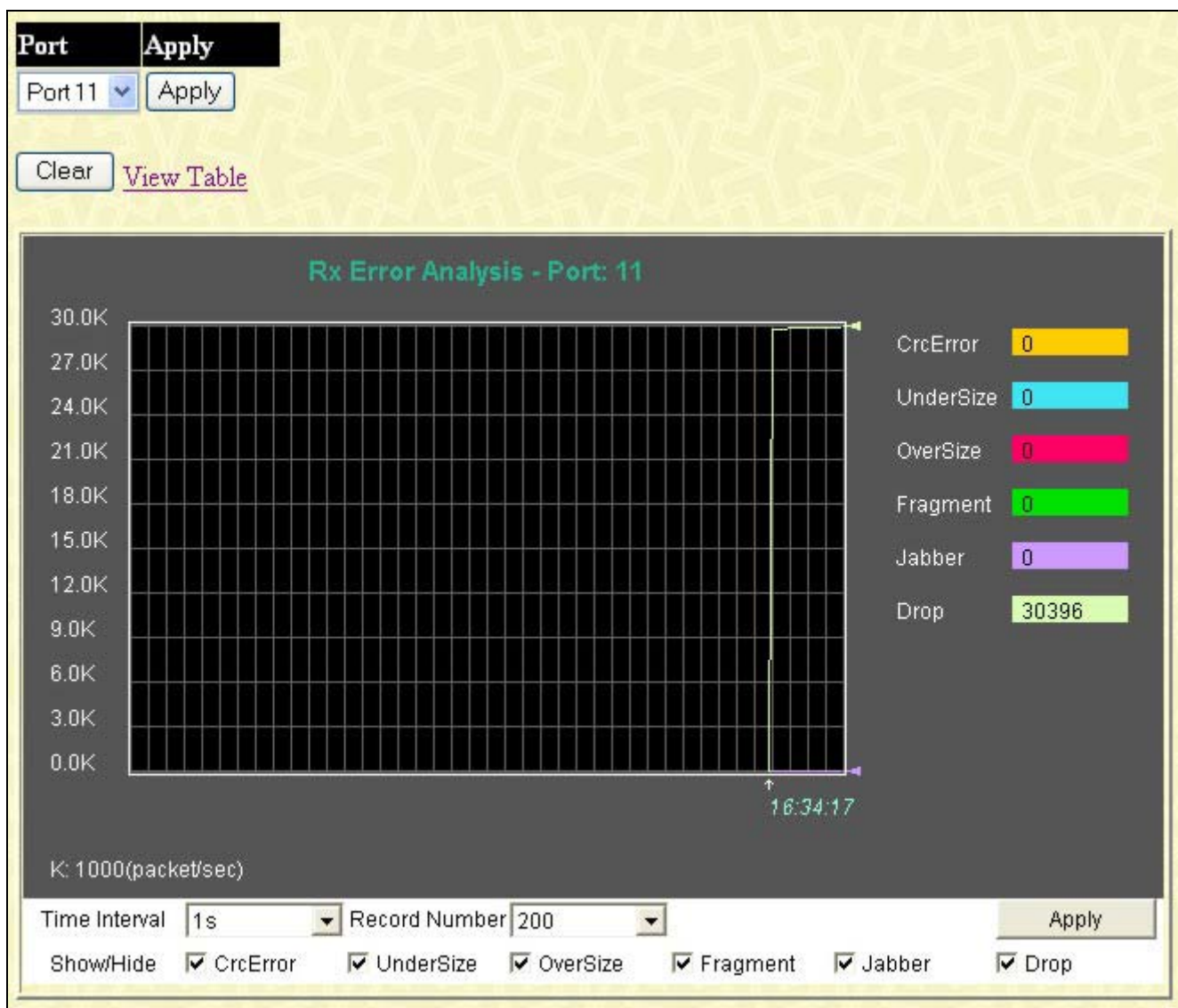

Figure 12- 11. Rx Error Analysis window (line graph)

To view the **Received Error Packets Table**, click the link **View Table**, which will show the following table:

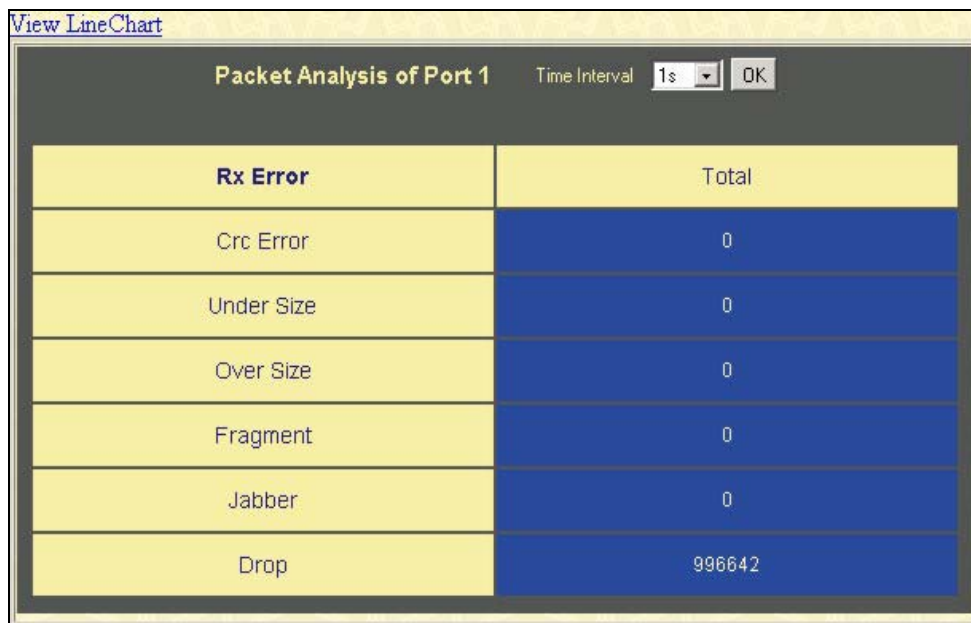

Figure 8- 62. Rx Error Analysis window (table)

The following fields can be set:

Parameter	Description
Time Interval	Select the desired setting between 1s and 60s, where "s" stands for seconds. The default value is one second.
Record Number	Select number of times the Switch will be polled between 20 and 200. The default value is 20.
Crc Error	Counts otherwise valid packets that did not end on a byte (octet) boundary.
Under Size	The number of packets detected that are less than the minimum permitted packets size of 64 bytes and have a good CRC. Undersize packets usually indicate collision fragments, a normal network occurrence.
Over Size	Counts packets received that were longer than 1518 octets, or if a VLAN frame is 1522 octets, and less than the MAX_PKT_LEN. Internally, MAX_PKT_LEN is equal to 1522.
Fragment	The number of packets less than 64 bytes with either bad framing or an invalid CRC. These are normally the result of collisions.
Jabber	The number of packets with lengths more than the MAX_PKT_LEN bytes. Internally, MAX_PKT_LEN is equal to 1522.
Drop	The number of packets that are dropped by this port since the last Switch reboot.
Show/Hide	Check whether or not to display Crc Error, Under Size, Over Size, Fragment, Jabber, and Drop errors.
Clear	Clicking this button clears all statistics counters on this window.
View Table	Clicking this button instructs the Switch to display a table rather than a line graph.
View Line Chart	Clicking this button instructs the Switch to display a line graph rather than a table.

Transmitted (TX)

Click the **Transmitted (TX)** link in the **Error** folder of the **Monitoring** menu to view the following graph of error packets received on the Switch.

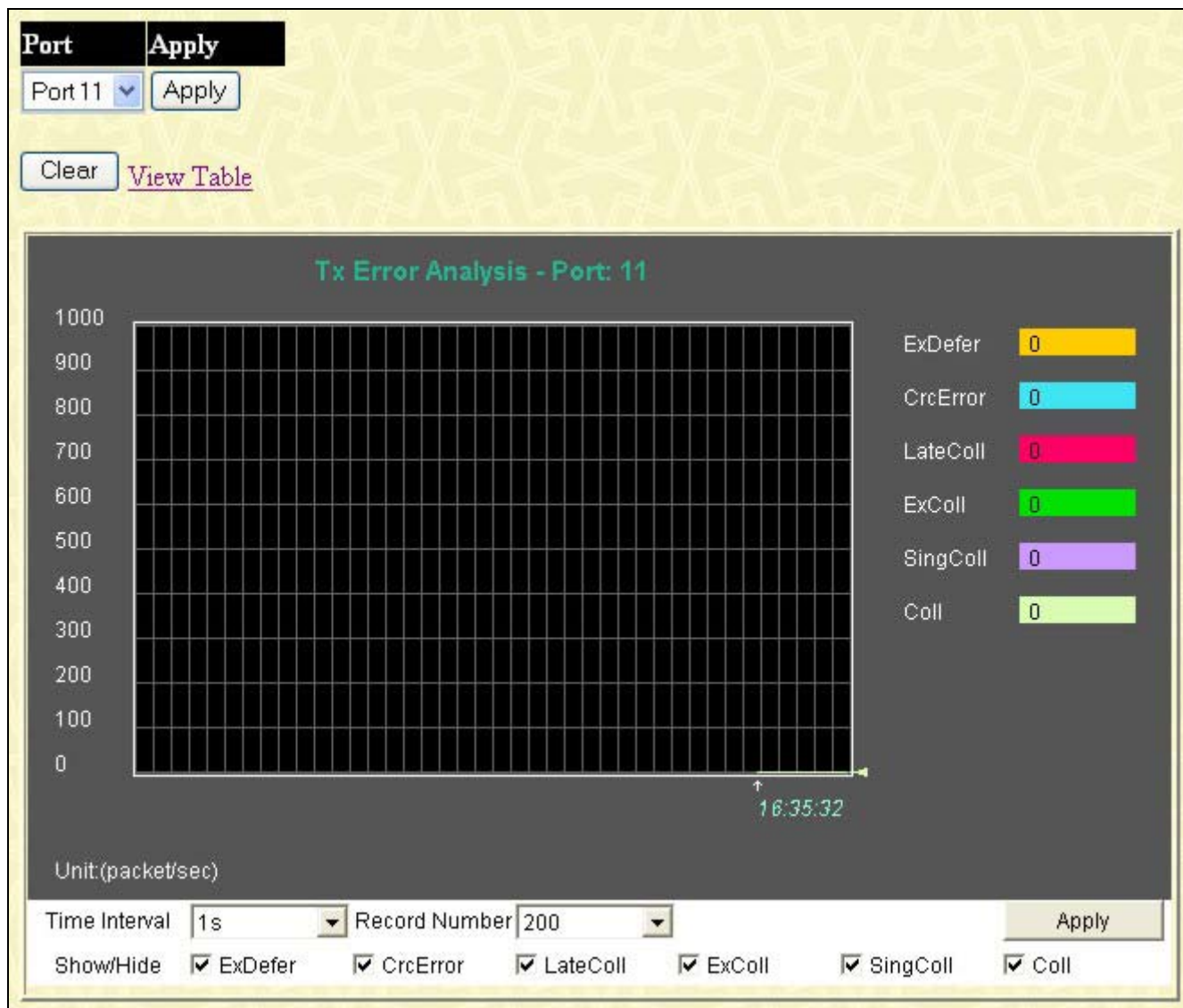

Figure 12- 12. Tx Error Analysis window (line graph)

To view the **Transmitted Error Packets Table**, click the link [View Table](#), which will show the following table:

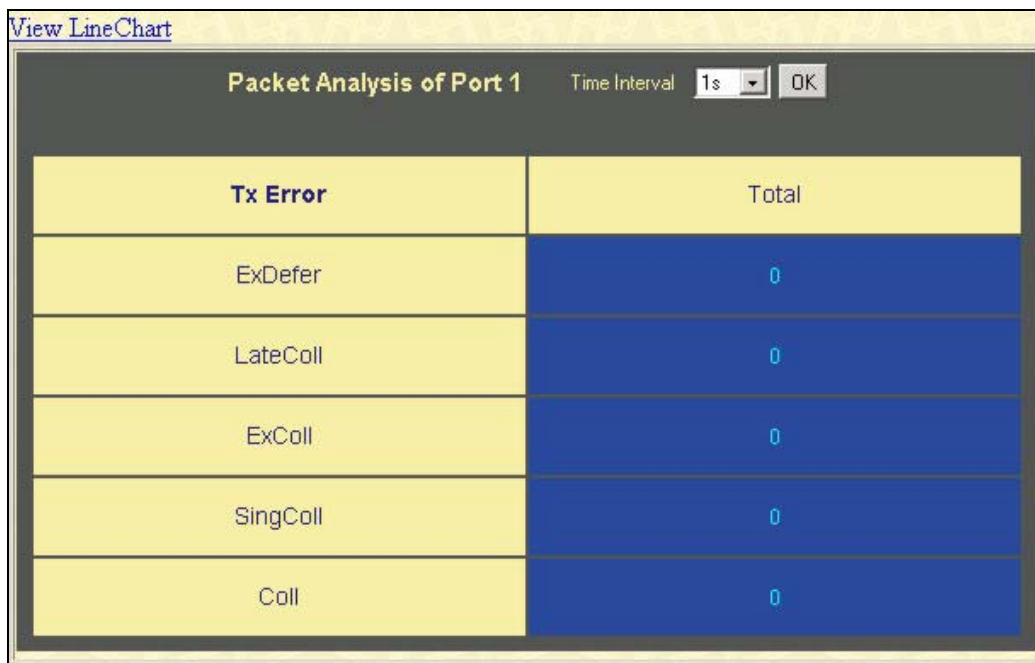

Figure 12- 13. Tx Error Analysis window (table)

The following fields may be set or viewed:

Parameter	Description
Time Interval	Select the desired setting between 1s and 60s, where "s" stands for seconds. The default value is one second.
Record Number	Select number of times the Switch will be polled between 20 and 200. The default value is 20.
ExDefer	Counts the number of packets for which the first transmission attempt on a particular interface was delayed because the medium was busy.
LateColl	Counts the number of times that a collision is detected later than 512 bit-times into the transmission of a packet.
ExColl	Excessive Collisions. The number of packets for which transmission failed due to excessive collisions.
SingColl	Single Collision Frames. The number of successfully transmitted packets for which transmission is inhibited by more than one collision.
Coll	An estimate of the total number of collisions on this network segment.
Show/Hide	Check whether or not to display ExDefer, LateColl, ExColl, SingColl, and Coll errors.
Clear	Clicking this button clears all statistics counters on this window.
View Table	Clicking this button instructs the Switch to display a table rather than a line graph.
View Line Chart	Clicking this button instructs the Switch to display a line graph rather than a table.

Packet Size

The Web Manager allows packets received by the Switch, arranged in six groups and classed by size, to be viewed as either a line graph or a table. Two windows are offered.



Figure 12- 14. Rx Size Analysis window (line graph)

To view the Packet Size Analysis Table, click the link [View Table](#), which will show the following table:

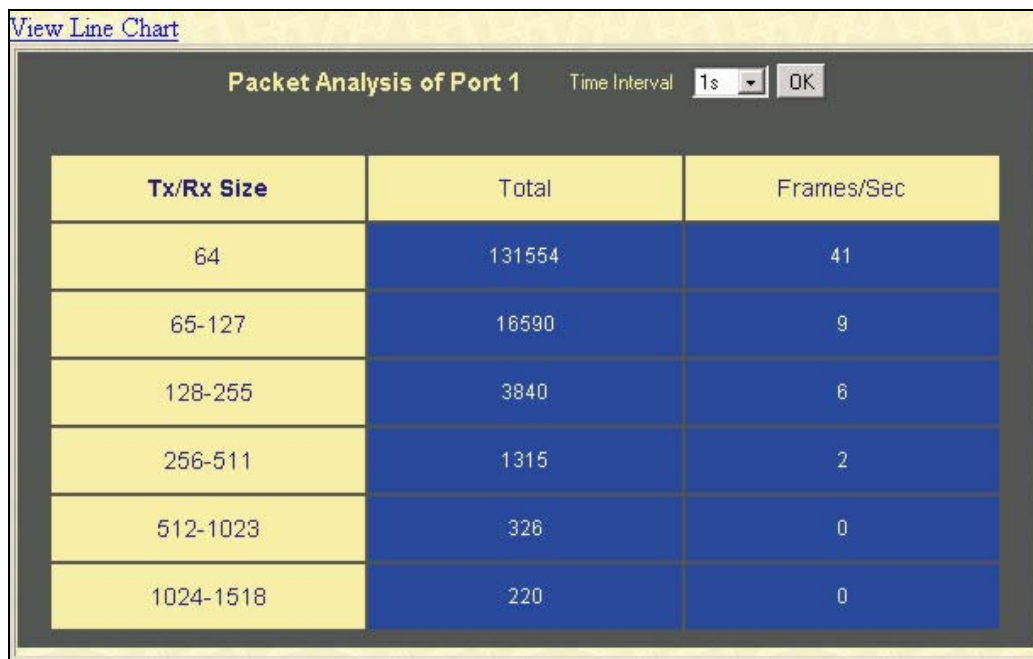

Figure 12- 15. Tx/Rx Packet Size Analysis window (table)

The following fields can be set or viewed:

Parameter	Description
Time Interval	Select the desired setting between 1s and 60s, where "s" stands for seconds. The default value is one second.
Record Number	Select number of times the Switch will be polled between 20 and 200. The default value is 20.
64	The total number of packets (including bad packets) received that were 64 octets in length (excluding framing bits but including FCS octets).
65-127	The total number of packets (including bad packets) received that were between 65 and 127 octets in length inclusive (excluding framing bits but including FCS octets).
128-255	The total number of packets (including bad packets) received that were between 128 and 255 octets in length inclusive (excluding framing bits but including FCS octets).
256-511	The total number of packets (including bad packets) received that were between 256 and 511 octets in length inclusive (excluding framing bits but including FCS octets).
512-1023	The total number of packets (including bad packets) received that were between 512 and 1023 octets in length inclusive (excluding framing bits but including FCS octets).
1024-1518	The total number of packets (including bad packets) received that were between 1024 and 1518 octets in length inclusive (excluding framing bits but including FCS octets).
Show/Hide	Check whether or not to display 64, 65-127, 128-255, 256-511, 512-1023, and 1024-1518 packets received.
Clear	Clicking this button clears all statistics counters on this window.
View Table	Clicking this button instructs the Switch to display a table rather than a line graph.
View Line Chart	Clicking this button instructs the Switch to display a line graph rather than a table.

Browse Router Port

This displays which of the Switch's ports are currently configured as router ports. A router port configured by a user (using the console or Web-based management interfaces) is displayed as a static router port, designated by S. D designates a router port that is dynamically configured by the Switch. To view the following window, open the **Monitoring** folder and click the **Browse Router Port** link.

Browse Router Port													
VLAN ID							VLAN Name						
1							default						
Ports													
1	2	3	4	5	6	7	8	9	10	11	12	13	14
15	16	17	18	19	20	21	22	23	24	25	26	27	28

Next

Figure 12- 16. Router Port window

Port Access Control

The following screens are used to monitor 802.1x statistics of the Switch, on a per port basis. To view the **Port Access Control** screens, open the monitoring folder and click the **Port Access Control** folder. There are six screens to monitor.



NOTE: The **Authenticator State** cannot be viewed on the Switch unless 802.1x is enabled by port or by MAC address. To enable 802.1x, go to the DES-3800 Web Management Tool menu.

RADIUS Authentication

This table contains information concerning the activity of the RADIUS authentication client on the client side of the RADIUS authentication protocol. It has one row for each RADIUS authentication server with which the client shares a secret. To view the **RADIUS Authentication**, click **Monitoring > Port Access Control > RADIUS Authentication**.

ServerIndex	InvalidServerAddr	Identifier	AuthServerAddr	ServerPortNumber	RoundTripTime	AccessRequests	AccessRetrans	AccessAccepts	AccessRejects	AccessChallenges	AccessResponses	BadAuthenticators	PendingRequests	Timeouts	UnknownTypes	PacketsDropped
1	100	100	100	100	100	100	100	100	100	100	100	100	100	100	100	100
2	100	100	100	100	100	100	100	100	100	100	100	100	100	100	100	100
3	100	100	100	100	100	100	100	100	100	100	100	100	100	100	100	100

Figure 12- 17. RADIUS Authentication window

The user may also select the desired time interval to update the statistics, between *1s* and *60s*, where “s” stands for seconds. The default value is one second. To clear the current statistics shown, click the *Clear* button in the top left hand corner.

The following fields can be viewed:

Parameter	Description
ServerIndex	The identification number assigned to each RADIUS Authentication server that the client shares a secret with.
InvalidServerAddr	The number of RADIUS Access-Response packets received from unknown addresses.
Identifier	The NAS-Identifier of the RADIUS authentication client. (This is not necessarily the same as sysName in MIB II.)
AuthServerAddr	The (conceptual) table listing the RADIUS authentication servers with which the client shares a secret.
ServerPortNumber	The UDP port the client is using to send requests to this server.
RoundTripTime	The time interval (in hundredths of a second) between the most recent Access-Reply/Access-Challenge and the Access-Request that matched it from this RADIUS authentication server.
AccessRequests	The number of RADIUS Access-Request packets sent to this server. This does not include retransmissions.
AccessRetrans	The number of RADIUS Access-Request packets retransmitted to this RADIUS authentication server.
AccessAccepts	The number of RADIUS Access-Accept packets (valid or invalid) received from this server.
AccessRejects	The number of RADIUS Access-Reject packets (valid or invalid) received from this server.
AccessChallenges	The number of RADIUS Access-Challenge packets (valid or invalid) received from this server.

AccessResponses	The number of malformed RADIUS Access-Response packets received from this server. Malformed packets include packets with an invalid length. Bad authenticators or Signature attributes or known types are not included as malformed access responses.
BadAuthenticators	The number of RADIUS Access-Response packets containing invalid authenticators or Signature attributes received from this server.
PendingRequests	The number of RADIUS Access-Request packets destined for this server that have not yet timed out or received a response. This variable is incremented when an Access-Request is sent and decremented due to receipt of an Access-Accept, Access-Reject or Access-Challenge, a timeout or retransmission.
Timeouts	The number of authentication timeouts to this server. After a timeout the client may retry to the same server, send to a different server, or give up. A retry to the same server is counted as a retransmit as well as a timeout. A send to a different server is counted as a Request as well as a timeout.
UnknownTypes	The number of RADIUS packets of unknown type which were received from this server on the authentication port
PacketsDropped	The number of RADIUS packets of which were received from this server on the authentication port and dropped for some other reason.

RADIUS Accounting

This window shows managed objects used for managing RADIUS accounting clients, and the current statistics associated with them. It has one row for each RADIUS authentication server that the client shares a secret with. To view the **RADIUS Accounting**, click **Monitoring > Port Access Control > RADIUS Accounting**.

ServerIndex	InvalidServerAddr	Identifier	ServerAddress	ServerPortNumber	RoundTripTime	Requests	Retransmissions	Responses	MalformedResponse	BadAuthenticators	PendingRequests	Timeouts	UnknownTypes	PacketsDropped
1	N/A	N/A	N/A	N/A	N/A	N/A	N/A	N/A	N/A	N/A	N/A	N/A	N/A	N/A
2	N/A	N/A	N/A	N/A	N/A	N/A	N/A	N/A	N/A	N/A	N/A	N/A	N/A	N/A
3	N/A	N/A	N/A	N/A	N/A	N/A	N/A	N/A	N/A	N/A	N/A	N/A	N/A	N/A

Figure 12- 18. RADIUS Accounting window

The user may also select the desired time interval to update the statistics, between 1s and 60s, where “s” stands for seconds. The default value is one second. To clear the current statistics shown, click the *Clear* button in the top left hand corner.

The following fields can be viewed:

Parameter	Description
ServerIndex	The identification number assigned to each RADIUS Accounting server that the client shares a secret with.
InvalidServerAddr	The number of RADIUS Accounting-Response packets received from unknown addresses.
Identifier	The NAS-Identifier of the RADIUS accounting client. (This is not necessarily the same as sysName in MIB II.)
ServerAddress	The (conceptual) table listing the RADIUS accounting servers with which the client shares a secret.
ServerPortNumber	The UDP port the client is using to send requests to this server.
RoundTripTime	The time interval between the most recent Accounting-Response and the Accounting-Request that matched it from this RADIUS accounting server.
Requests	The number of RADIUS Accounting-Request packets sent. This does not include retransmissions.

Retransmissions	The number of RADIUS Accounting-Request packets retransmitted to this RADIUS accounting server. Retransmissions include retries where the Identifier and Acct-Delay have been updated, as well as those in which they remain the same.
Responses	The number of RADIUS packets received on the accounting port from this server.
MalformedResponses	The number of malformed RADIUS Accounting-Response packets received from this server. Malformed packets include packets with an invalid length. Bad authenticators and unknown types are not included as malformed accounting responses.
BadAuthenticators	The number of RADIUS Accounting-Response packets, which contained invalid authenticators, received from this server.
PendingRequests	The number of RADIUS Accounting-Request packets sent to this server that have not yet timed out or received a response. This variable is incremented when an Accounting-Request is sent and decremented due to receipt of an Accounting-Response, a timeout or a retransmission.
Timeouts	The number of accounting timeouts to this server. After a timeout the client may retry to the same server, send to a different server, or give up. A retry to the same server is counted as a retransmit as well as a timeout. A send to a different server is counted as an Accounting-Request as well as a timeout.
UnknownTypes	The number of RADIUS packets of unknown type which were received from this server on the accounting port.
PacketsDropped	The number of RADIUS packets, which were received from this server on the accounting port and dropped for some other reason.

Authenticator State

The following section describes the 802.1X Status on the Switch. To view the Authenticator State, click **Monitoring > Port Access Control > Authenticator State**.

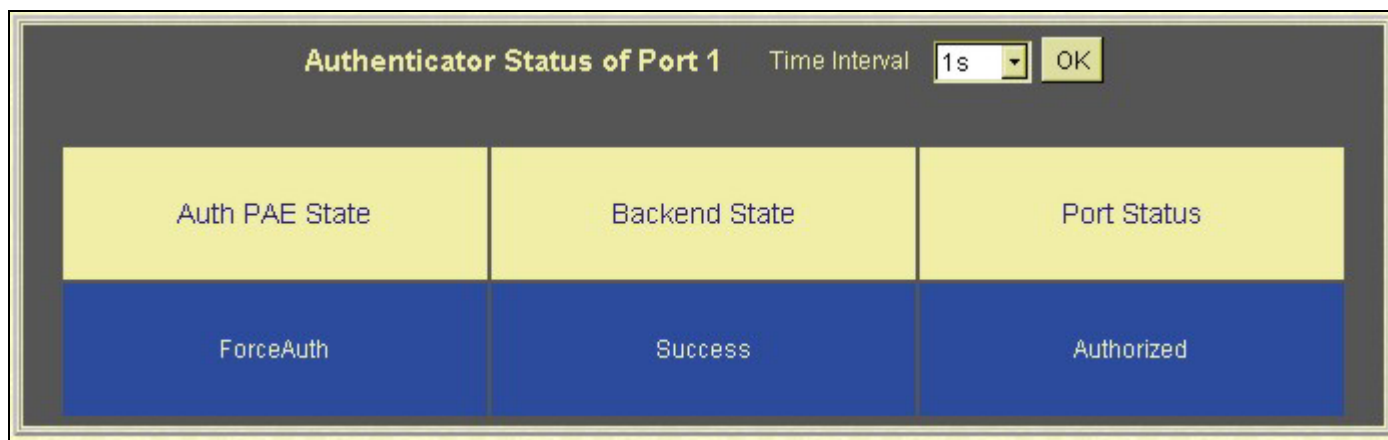

This window displays the **Authenticator State** for individual ports on a selected device. To select unit within the switch stack, use the pull-down menu at the top of the window and click **Apply**. A polling interval between 1 and 60 seconds can be set using the drop-down menu at the top of the window and clicking **OK**.

The information on this window is described as follows:

Parameter	Description
Auth PAE State	The Authenticator PAE State value can be: <i>Initialize, Disconnected, Connecting, Authenticating, Authenticated, Aborting, Held, Force_Auth, Force_Unauth, or N/A</i> . N/A (Not Available) indicates that the port's authenticator capability is disabled.
Backend State	The Backend Authentication State can be <i>Request, Response, Success, Fail, Timeout, Idle, Initialize, or N/A</i> . N/A (Not Available) indicates that the port's authenticator capability is disabled.
Port Status	Controlled Port Status can be <i>Authorized, Unauthorized, or N/A</i> .

MAC Address Table

This allows the Switch's dynamic MAC address forwarding table to be viewed. When the Switch learns an association between a MAC address and a port number, it makes an entry into its forwarding table. These entries are then used to forward packets through the Switch.

To view the MAC Address forwarding table, from the **Monitoring** menu, click the **MAC Address Table** link:

The screenshot shows the MAC Address Table window with search filters and a table of entries. The search filters include VLAN Name, MAC Address, and Port. The table has columns for VID, VLAN Name, MAC Address, Port, and Type. The total number of entries is 368.

VID	VLAN Name	MAC Address	Port	Type
1	default	00-00-01-02-03-a2	11	Dynamic
1	default	00-00-55-03-01-00	11	Dynamic
1	default	00-00-55-46-03-00	11	Dynamic
1	default	00-00-81-9a-99-4f	11	Dynamic
1	default	00-00-81-9a-f2-f4	11	Dynamic
1	default	00-01-02-03-04-00	CPU	Self
1	default	00-01-30-12-13-02	11	Dynamic
1	default	00-01-4a-9f-57-48	11	Dynamic
1	default	00-01-6c-ce-62-e0	11	Dynamic
1	default	00-01-80-24-dc-f5	11	Dynamic
1	default	00-01-e7-47-39-00	11	Dynamic
1	default	00-01-e7-47-39-21	11	Dynamic
1	default	00-02-3f-72-c4-eb	11	Dynamic
1	default	00-02-a5-fd-66-97	11	Dynamic
1	default	00-02-b3-a5-a9-19	11	Dynamic
1	default	00-03-09-18-10-01	11	Dynamic
1	default	00-03-6d-1e-76-79	11	Dynamic
1	default	00-03-9d-73-32-f0	11	Dynamic
1	default	00-04-13-04-03-01	11	Dynamic
1	default	00-04-96-05-40-22	11	Dynamic

Figure 12- 19. MAC Address Table window

The following fields can be viewed or set:

Parameter	Description
VLAN Name	Enter a VLAN Name for which to browse the forwarding table.
MAC Address	Enter a MAC address for which to browse the forwarding table.
Find	Allows the user to move to a sector of the database corresponding to a user defined port, VLAN, or MAC address.
VID	The VLAN ID of the VLAN the port is a member of.
MAC Address	The MAC address entered into the address table.
Port	The port that the MAC address above corresponds to.
Type	How the Switch discovered the MAC address. The possible entries are Dynamic, Self, and Static.
Next	Click this button to view the next page of the address table.
Clear Dynamic Entry	Clicking this button will clear Dynamic entries learned by the Switch. This may be accomplished by VLAN Name or by Port.
View All Entry	Clicking this button will allow the user to view all entries of the address table.
Clear All Entry	Clicking this button will allow the user to delete all entries of the address table.

IP Address Table

The **IP Address Table** may be found in the **Monitoring** menu. The **IP Address Table** is a read only screen where the user may view IP addresses discovered by the Switch. To search a specific IP address, enter it into the field labeled **IP Address** at the top of the screen and click **Find** to begin your search.

IP Address		0.0.0.0	Find
IP Address Table			
Interface	IP Address	Port	Learned
System	10.1.1.101	11	Dynamic
System	10.1.1.151	11	Dynamic
System	10.1.1.152	11	Dynamic
System	10.1.1.154	11	Dynamic
System	10.1.1.157	11	Dynamic
System	10.1.1.161	11	Dynamic
System	10.1.1.162	11	Dynamic
System	10.1.1.163	11	Dynamic
System	10.1.1.164	11	Dynamic
System	10.1.1.167	11	Dynamic
System	10.1.1.168	11	Dynamic
System	10.1.1.169	11	Dynamic
System	10.1.1.170	11	Dynamic
System	10.1.1.171	11	Dynamic
System	10.1.1.172	11	Dynamic
System	10.1.1.173	11	Dynamic
System	10.1.1.174	11	Dynamic
System	10.1.1.175	11	Dynamic
System	10.1.1.176	11	Dynamic
System	10.1.1.177	11	Dynamic

Total Entries: 222

Next

Figure 12- 20. IP Address Table window

Browse Routing Table

The **Browse Routing Table** window may be found in the **Monitoring** menu. This screen shows the current IP routing table of the Switch. To find a specific IP route, enter an IP address into the **Destination Address** field along with a proper subnet mask into the **Mask** field and click **Find**.

IP Address	0.0.0.0			
Netmask	0.0.0.0		Find	

Routing Table					
IP Address	Netmask	Gateway	Interface	Cost	Protocol
0.0.0.0	0.0.0.0	10.48.45.121	System	1	Default
10.0.0.0	255.0.0.0	0.0.0.0	System	1	Local

Total Entries: 2

Figure 12- 21. Browse Routing Table window

Browse ARP Table

The **Browse ARP Table** window may be found in the **Monitoring** menu. This window will show current ARP entries on the Switch. To search a specific ARP entry, enter an interface name into the **Interface Name** or an **IP address** and click **Find**. To clear the **ARP Table**, click **Clear All**.

Interface Name			
IP Address	0.0.0.0	Find	Clear All

ARP Table			
Interface Name	IP Address	MAC Address	Type
System	10.0.0.0	ff-ff-ff-ff-ff-ff	Local/Broadcast
System	10.1.1.101	00-50-ba-15-48-56	Dynamic
System	10.1.1.151	00-50-ba-70-d6-d0	Dynamic
System	10.1.1.152	00-13-00-00-00-01	Dynamic
System	10.1.1.154	00-50-ba-97-d9-56	Dynamic
System	10.1.1.157	00-50-ba-71-20-d6	Dynamic
System	10.1.1.161	00-50-ba-70-e4-89	Dynamic
System	10.1.1.162	00-50-ba-70-e4-5a	Dynamic
System	10.1.1.163	00-50-ba-70-e4-55	Dynamic
System	10.1.1.164	00-50-ba-70-e4-65	Dynamic
System	10.1.1.167	00-50-ba-70-e4-45	Dynamic
System	10.1.1.168	00-50-ba-70-e4-57	Dynamic
System	10.1.1.169	00-50-ba-70-e4-4e	Dynamic
System	10.1.1.170	00-50-ba-70-e4-7a	Dynamic
System	10.1.1.171	00-50-ba-70-cc-19	Dynamic
System	10.1.1.172	00-50-ba-70-e4-49	Dynamic
System	10.1.1.173	00-50-ba-70-e4-6e	Dynamic
System	10.1.1.174	00-50-ba-70-e4-7e	Dynamic
System	10.1.1.175	00-50-ba-70-e4-46	Dynamic
System	10.1.1.176	00-50-ba-70-e4-8f	Dynamic

Total Entries: 261

Figure 12- 22. Browse ARP Table window

Browse IP Multicast Forwarding Table

The **Browse IP Multicast Forwarding Table** window may be found in the **Monitoring** menu. This window will show current IP multicasting information on the Switch. To search a specific entry, enter a multicast group IP address into the **Multicast Group** field or a **Source IP** address and click **Find**.

Multicast Group	<input type="text" value="0.0.0.0"/>				
Source IP Address	<input type="text" value="0.0.0.0"/>		<input type="button" value="Find"/>		
IP Multicast Forwarding Table					
Multicast Group	Source IP Address	Source Netmask	Upstream Neighbor	Expire Time	Protocol
224.2.140.247	10.0.0.0	255.0.0.0	10.100.100.251	109	DVMRP
224.2.142.32	10.0.0.0	255.0.0.0	10.100.100.251	105	DVMRP
229.55.150.208	10.0.0.0	255.0.0.0	10.100.100.251	118	DVMRP
239.255.255.250	10.0.0.0	255.0.0.0	10.100.100.251	39	DVMRP
Total Entries: 4					

Figure 12- 23. Browse IP Multicast Forwarding Table

IGMP Snooping Group

IGMP Snooping allows the Switch to read the Multicast Group IP address and the corresponding MAC address from IGMP packets that pass through the Switch. The number of IGMP reports that were snooped is displayed in the Reports field. To view the **IGMP Snooping Group Table**, click **IGMP Snooping Group** in the **Monitoring** menu:

VLAN Name :	<input type="text"/>	<input type="button" value="Search"/>												
Total Entries : 0														
IGMP Snooping Group Table														
VLAN Name	Multicast Group	MAC Address	Reports											
	0.0.0.0	00:00:00:00:00:00	0											
	Port Member													
Unit	1	2	3	4	5	6	7	8	9	10	11	12	13	14
	15	16	17	18	19	20	21	22	23	24	25	26	27	28

Figure 12- 24. IGMP Snooping Group Table

The user may search the IGMP Snooping Table by entering the VLAN Name in the top left hand corner and clicking **Search**.



NOTE: The Switch supports up to 256 IGMP Snooping groups.

The following field can be viewed:

Parameter	Description
VLAN Name	The VLAN Name of the multicast group.
Multicast Group	The IP address of the multicast group.
MAC Address	The MAC address of the multicast group.
Reports	The total number of reports received for this group.
Port Member	These are the ports where the IGMP packets were snooped are displayed.

IGMP Snooping Forwarding

This window will display the current IGMP snooping forwarding table entries currently configured on the Switch. To view the following screen, open the **Monitoring** folder and click the **IGMP Snooping Forwarding** link.

VLAN Name : Search

Total Entries : 0

IGMP Snooping Forwarding Table

VLAN Name	Source IP	Multicast Group
	0.0.0.0	0.0.0.0

Unit	Port Member													
	1	2	3	4	5	6	7	8	9	10	11	12	13	14
	15	16	17	18	19	20	21	22	23	24	25	26	27	28

Figure 12- 25. IGMP Snooping Forwarding Table

The user may search the **IGMP Snooping Forwarding Table** by entering the VLAN Name in the top left hand corner and clicking the **Search** button.

The following field can be viewed:

Parameter	Description
VLAN Name	The VLAN Name of the multicast group.
Source IP	The IP address of the multicast Source.
Multicast Group	The IP MAC address of the multicast group.
Port Member	These are the ports where the IGMP packets that were snooped are displayed.

Browse IGMP Group Table

The **Browse IGMP Group Table** window may be found in the **Monitoring** menu. This window will show current IGMP group entries on the Switch. To search a specific IGMP group entry, enter an interface name into the **Interface Name** field or a **Multicast Group** IP address and click **Find**.

Interface Name Multicast Group Find

IGMP Group Table

Interface Name	Multicast Group	Last Reporter IP	Querier IP	Expire Time	Group Filter Mode	V1 Host Timer	V2 Host Timer	Detail
n11	225.1.0.1	11.11.11.2	SELF	243	exclude 0	243	View	
n11	225.1.0.2	11.11.11.2	SELF	240	exclude 0	240	View	
n11	225.1.0.3	11.11.11.2	SELF	241	exclude 0	241	View	
n11	225.1.0.4	11.11.11.2	SELF	239	exclude 0	239	View	
n11	225.1.0.5	11.11.11.2	SELF	240	exclude 0	240	View	
n11	225.1.0.6	11.11.11.2	SELF	240	exclude 0	240	View	
n11	225.1.0.7	11.11.11.2	SELF	244	exclude 0	244	View	
n11	225.1.0.8	11.11.11.2	SELF	239	exclude 0	239	View	
n11	225.1.0.9	11.11.11.2	SELF	242	exclude 0	242	View	
n11	225.1.0.10	11.11.11.2	SELF	244	exclude 0	244	View	
n11	225.1.0.11	11.11.11.2	SELF	236	exclude 0	236	View	
n11	225.1.0.12	11.11.11.2	SELF	239	exclude 0	239	View	
n11	225.1.0.13	11.11.11.2	SELF	241	exclude 0	241	View	
n11	225.1.0.14	11.11.11.2	SELF	241	exclude 0	241	View	
n11	225.1.0.15	11.11.11.2	SELF	235	exclude 0	235	View	
n11	225.1.0.16	11.11.11.2	SELF	242	exclude 0	242	View	
n11	225.1.0.17	11.11.11.2	SELF	243	exclude 0	243	View	
n11	225.1.0.18	11.11.11.2	SELF	238	exclude 0	238	View	
n11	225.1.0.19	11.11.11.2	SELF	240	exclude 0	240	View	
n11	225.1.0.20	11.11.11.2	SELF	236	exclude 0	236	View	

Total Entries: 100 [Next](#)

Figure 12- 26. Browse IGMP Group Table

To view the details about a particular IGMP Group entry, click the corresponding [View](#) button, which will display the following window.

IGMP Group Detail	
Interface Name	n11
Multicast Group	225.1.0.1
Last Reporter IP	11.11.11.2
Querier IP	SELF
Expire Time	172
Group Filter Mode	exclude
V1 Host Timer	0
V2 Host Timer	172
Source List Table	
Source Address	Timer
Show All IGMP Group Entries	

Figure 12- 27. IGMP Group Detail window

DVMRP Monitoring

This menu allows the **DVMRP** (Distance-Vector Multicast Routing Protocol) to be monitored for each IP interface defined on the Switch. This folder, found in the **Monitoring** folder, offers 4 screens for monitoring: **Browse DVMRP Routing Table**, **Browse DVMRP Neighbor Address Table**, **Browse DVMRP Routing Next Hop Table** and **Browse PIM Neighbor Table**.

Browse DVMRP Routing Table

Multicast routing information is gathered and stored by DVMRP in the **DVMRP Routing Table**, which may be found in the **Monitoring** folder under **Browse DVMRP Monitoring**, contains one row for each port in a DVMRP mode. Each routing entry contains information about the source and multicast group, and incoming and outgoing interfaces. You may define your search by entering a **Source IP Address** and its subnet mask into the fields at the top of the page.

Source IP Address	<input type="text" value="0.0.0.0"/>					
Source Netmask	<input type="text" value="0.0.0.0"/>	<input type="button" value="Browse"/>				
DVMRP Routing Table						
Source IP Address	Source Netmask	Upstream Neighbor	Metric	Learned	Interface Name	Expire Time
Total Entries: 0						

Figure 12- 28. DVMRP Routing Table

Browse DVMRP Neighbor Table

This table, found in the **Monitoring** menu under **DVMRP Monitor > Browse DVMRP Neighbor Table** contains information about DVMRP neighbors of the Switch. To search this table, enter either an **Interface Name** or **Neighbor Address** into the respective field and click the **Find** button. DVMRP neighbors of that entry will appear in the **DVMRP Neighbor Table** below.

Interface Name	<input type="text"/>		
Neighbor IP Address	<input type="text" value="0.0.0.0"/>	<input type="button" value="Find"/>	
DVMRP Neighbor Table			
Interface Name	Neighbor IP Address	Generation ID	Expire Time
Total Entries: 0			

Figure 12- 29. DVMRP Neighbor Table

Browse DVMRP Routing Next Hop Table

The **DVMRP Routing Next Hop Table** contains information regarding the next-hop for forwarding multicast packets on outgoing interfaces. Each entry in the **DVMRP Routing Next Hop Table** refers to the next-hop of a specific source to a specific multicast group address. This table is found in the **Monitoring** menu under **DVMRP Monitoring**, with the heading **Browse DVMRP Routing Next Hop Table**. To search this table, enter either an **Interface Name** or **Source IP Address** into the respective field and click the **Find** button. The next hop of that DVMRP Routing entry will appear in the **DVMRP Routing Next Hop Table** below.

Interface Name	<input type="text"/>	
Source IP Address	<input type="text" value="0.0.0.0"/>	<input type="button" value="Find"/>
DVMRP Routing Next Hop Table		
Source IP Address	Source Netmask	Interface Name
Type		
Total Entries: 0		

Figure 12- 30. DVMRP Routing Next Hop Table

Browse PIM Neighbor Table

Multicast routers use **Protocol Independent Multicast (PIM)** determine which other multicast routers should receive multicast packets. The **PIM Neighbor Address Table** contains information regarding each of a router’s PIM neighbors. This screen may be found in the **Monitoring** folder under the heading **PIM Monitor**. To search this table, enter either an **Interface Name** or **Neighbor Address** into the respective field and click the **Find** button. PIM neighbors of that entry will appear in the **PIM Neighbor Table** below.

Interface Name	<input type="text"/>	
Neighbor IP Address	<input type="text" value="0.0.0.0"/>	<input type="button" value="Find"/>
PIM Neighbor Table		
Interface Name	Neighbor IP Address	Expire Time
Total Entries: 0		

Figure 12- 31. PIM Neighbor Table

OSPF Monitoring

This section offers windows regarding OSPF (Open Shortest Path First) information on the Switch, including the **OSPF LSDB Table**, **OSPF Neighbor Table** and the **OSPF Virtual Neighbor Table**. To view these tables, open the **Monitoring** folder and click **OSPF Monitoring**.

Browse OSPF LSDB Table

This table, located in the **Monitoring** folder, can be found in the **OSPF Monitor** folder, by clicking on the **Browse OSPF LSDB Table** link. The **OSPF Link-State Database Table** displays the current link-state database in use by the OSPF routing protocol on a per-OSPF area basis.

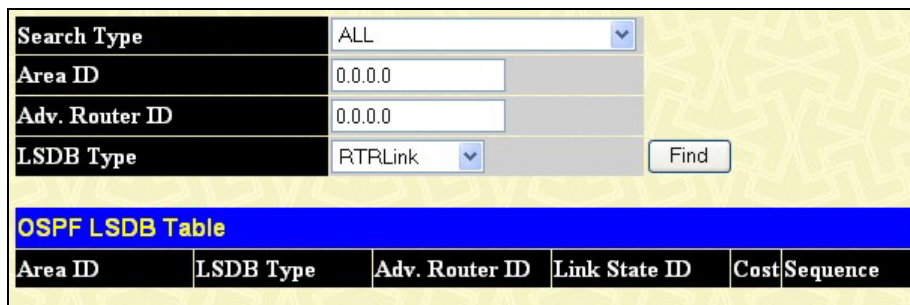

Figure 12- 32. Browse OSPF LSDB Table

The user may search for a specific entry by entering the following information into the fields at the top of the screen:

To browse the **OSPF LSDB Table**, you first must select which browse method you want to use in the **Search Type** field. The choices are *All*, *Area ID*, *Advertise Router ID*, *LSDB*, *Area ID & Advertise Router ID*, *Area ID & LSDB*, and *Advertise Router ID & LSDB*.

If *Area ID* is selected as the browse method, you must enter the IP address in the **Area ID** field, and then click *Find*.

If *Adv. Router ID* is selected, you must enter the IP address in the **Adv. Router ID** field, and then click *Find*.

If *LSDB* is selected, you must select the type of link state (*RtrLink*, *NetLink*, *Summary*, *ASSummary* and *ASExtLink*) in the **LSDB Type** field, and then click *Find*.

The following fields are displayed in the **OSPF LSDB Table**:

Parameter	Description										
Area ID	Allows the entry of an OSPF Area ID. This Area ID will then be used to search the table, and display an entry – if there is one.										
LSDB Type	Displays which one of eight types of link advertisements by which the current link was discovered by the Switch: <i>All</i> , Router link (<i>RTRLink</i>), Network link (<i>NETLink</i>), Summary link (<i>Summary</i>), Autonomous System link (<i>ASSummary</i>), Autonomous System external link (<i>ASExternal</i>), MCGLink (<i>Multicast Group</i>), and NSSA (<i>Not So Stubby Area</i>)										
Adv. Router ID	Displays the Advertising Router’s ID.										
Link State ID	This field identifies the portion of the Internet environment that is being described by the advertisement. The contents of this field depend on the advertisement’s LS type. <table border="1" style="width: 100%; border-collapse: collapse;"> <thead> <tr> <th>LS Type</th> <th>Link State ID</th> </tr> </thead> <tbody> <tr> <td>1</td> <td>The originating router’s Router ID.</td> </tr> <tr> <td>2</td> <td>The IP interface address of the network’s Designated Router.</td> </tr> <tr> <td>3</td> <td>The destination network’s IP address.</td> </tr> <tr> <td>4</td> <td>The Router ID of the described AS boundary router.</td> </tr> </tbody> </table>	LS Type	Link State ID	1	The originating router’s Router ID.	2	The IP interface address of the network’s Designated Router.	3	The destination network’s IP address.	4	The Router ID of the described AS boundary router.
LS Type	Link State ID										
1	The originating router’s Router ID.										
2	The IP interface address of the network’s Designated Router.										
3	The destination network’s IP address.										
4	The Router ID of the described AS boundary router.										
Cost	Displays the cost of the table entry.										
Sequence	Displays a sequence number corresponding to number of times the current link has been advertised as changed.										

Browse OSPF Neighbor Table

This table can be found in the **OSPF Monitoring** folder by clicking on the **Browse OSPF Neighbor Table** link. Routers that are connected to the same area or segment become neighbors in that area. Neighbors are elected via the Hello protocol. IP multicast is used to send out Hello packets to other routers on the segment. Routers become neighbors when they see themselves listed in a Hello packet sent by another router on the same segment. In this way, two-way communication is guaranteed to be possible between any two-neighbor routers. This table displays OSPF neighbors of the Switch.

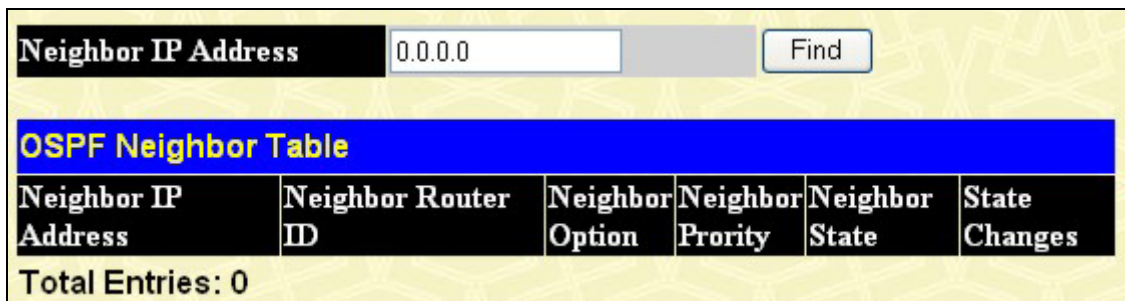

Figure 12- 33. OSPF Neighbor Table

To search for OSPF neighbors, enter an IP address and click **Find**. Valid OSPF neighbors will appear in the **OSPF Neighbor Table** below.

Browse OSPF Virtual Neighbor Table

This table can be found in the **Monitoring** folder by clicking on the **Browse OSPF Virtual Neighbor Table** link in the **OSPF Monitoring** folder. This table displays a list of **Virtual OSPF Neighbors** of the Switch. The user may choose specifically search a virtual neighbor by using one of the two search options at the top of the screen, which are:

Parameter	Description
Transit Area ID	Allows the entry of an OSPF Area ID – previously defined on the Switch – that allows a remote area to communicate with the backbone (area 0). A Transit Area cannot be a Stub Area or a Backbone Area.
Virtual Neighbor Router ID	The OSPF router ID for the remote router. This IP address uniquely identifies the remote area’s Area Border Router.

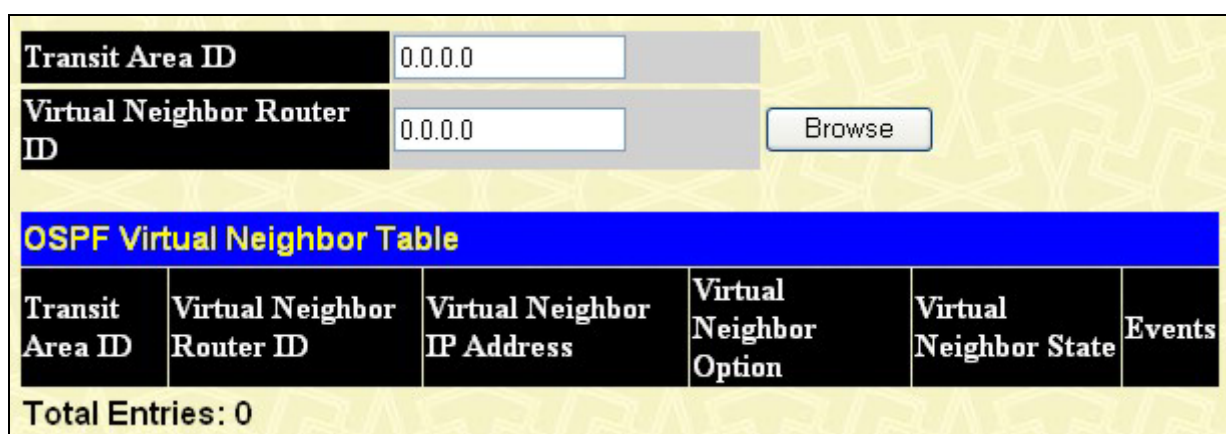

Figure 12- 34. OSPF Virtual Neighbor Table

Browse PoE Status (for DES-3828P only)

This table can be found in the **Monitoring** folder by clicking on the **Browse PoE Status** folder. This table displays the current PoE System and PoE Port settings.

PoE System Status	
Power Limit (W)	372
Power Consumption (W)	0
Power Remained (W)	372
Power Disconnection Method	Deny next port

PoE Port Status								
Port	State	Priority	Power Limit (mW)	Class	Power (mW)	Voltage (decivolt)	Current (mW)	Status
1	Enabled	Low	15400	0	0	0	0	OFF : Improper Capacitor Detection results
2	Enabled	Low	15400	0	0	0	0	OFF : Interim state during line detection
3	Enabled	Low	15400	0	0	0	0	OFF : Interim state during line detection
4	Enabled	Low	15400	0	0	0	0	OFF : Interim state during line detection
5	Enabled	Low	15400	0	0	0	0	OFF : Interim state during line detection
6	Enabled	Low	15400	0	0	0	0	OFF : Interim state during line detection
7	Enabled	Low	15400	0	0	0	0	OFF : Interim state during line detection
8	Enabled	Low	15400	0	0	0	0	OFF : Interim state during line detection
9	Enabled	Low	15400	0	0	0	0	OFF : Interim state during line detection
10	Enabled	Low	15400	0	0	0	0	OFF : Interim state during line detection
11	Enabled	Low	15400	0	0	0	0	OFF : Interim state during line detection
12	Enabled	Low	15400	0	0	0	0	OFF : Interim state during line detection
13	Enabled	Low	15400	0	0	0	0	OFF : Interim state during line detection
14	Enabled	Low	15400	0	0	0	0	OFF : Interim state during line detection
15	Enabled	Low	15400	0	0	0	0	OFF : Interim state during line detection
16	Enabled	Low	15400	0	0	0	0	OFF : Interim state during line detection
17	Enabled	Low	15400	0	0	0	0	OFF : Interim state during line detection
18	Enabled	Low	15400	0	0	0	0	OFF : Interim state during line detection
19	Enabled	Low	15400	0	0	0	0	OFF : Interim state during line detection
20	Enabled	Low	15400	0	0	0	0	OFF : Interim state during line detection
21	Enabled	Low	15400	0	0	0	0	OFF : Interim state during line detection
22	Enabled	Low	15400	0	0	0	0	OFF : Interim state during line detection
23	Enabled	Low	15400	0	0	0	0	OFF : Interim state during line detection
24	Enabled	Low	15400	0	0	0	0	OFF : Interim state during line detection

Figure 12- 35. Browse PoE Status window

Browse WRED Settings

The following window displays the WRED settings currently employed on the Switch. To view this window, click **Monitoring > Browse WRED Settings**.

The screenshot shows a web interface for viewing WRED settings. At the top, there is a search bar labeled "Search Port" with a dropdown menu set to "Port 1" and a "Find" button. Below this is a blue header bar that reads "WRED Settings - Find by Port: 1". Underneath is a table with three columns: "Class ID", "Drop Start", and "Drop Slope". The table contains eight rows, one for each Class ID from 0 to 7. All "Drop Start" values are 50 and all "Drop Slope" values are 45. At the bottom of the window, it displays "Average Time: 100 microseconds".

Class ID	Drop Start	Drop Slope
0	50	45
1	50	45
2	50	45
3	50	45
4	50	45
5	50	45
6	50	45
7	50	45

Average Time: 100 microseconds

Figure 12- 36. WRED Settings window

The following parameters are displayed above

Parameter	Description
Search Port	Select a port using the pull down menu by which to display the WRED settings.
Class ID	Displays the Class IDs on the port currently being viewed.
Drop Start	Displays the Drop Start set as a percentage from 1-100.
Drop Slope	Displays the Drop Slope set as a degree between 0 and 90.
Average Time	Displays the average time the WRED mechanism checks the packet fill of the QoS queues and the rate of ingress packets.

Switch Log

The Web manager allows the Switch's history log, as compiled by the Switch's management agent, to be viewed. To view the Switch history log, open the **Monitoring** folder and click the **Switch Log** link.

Switch History Log		
Sequence	Time	Log Text
73	2000/01/01 01:22:08	Successful login through Web (Username: Anonymous)
72	2000/01/01 01:21:45	Port 11 link up, 100Mbps FULL duplex
71	2000/01/01 01:21:45	Configuration had 2 syntax error and 0 execute error
70	2000/01/01 01:21:45	System started up
69	2000/01/01 01:21:39	Redundant Power failed
68	2000/01/01 01:21:39	FAN 1 (1:back fan, 2:side fan) failed
67	2000/01/01 01:21:36	Spanning Tree Protocol is disabled
66	1999/12/31 19:56:10	Configuration saved to flash (Username: Anonymous)
65	1999/12/31 19:46:23	Console session timed out (Username: Anonymous)
64	1999/12/31 19:36:12	Successful login through Console (Username: Anonymous)
63	1999/12/31 18:27:10	Console session timed out (Username: Anonymous)
62	1999/12/31 18:16:43	Configuration saved to flash (Username: Anonymous)
61	1999/12/31 18:16:22	Successful login through Console (Username: Anonymous)
60	1999/12/31 18:15:46	Logout through Console (Username: Anonymous)
59	1999/12/31 18:15:20	Configuration saved to flash (Username: Anonymous)
58	1999/12/31 18:14:17	Successful login through Console (Username: Anonymous)
57	1999/12/31 18:14:17	Logout through Console (Username: Anonymous)
56	1999/12/31 18:14:09	Successful login through Console (Username: Anonymous)
55	1999/12/31 18:13:12	Console session timed out (Username: Anonymous)
54	1999/12/31 18:04:13	Successful login through Web (Username: Anonymous)

Clear Next

Figure 12- 37. Switch History window

The Switch can record event information in its own logs, to designated SNMP trap receiving stations, and to the PC connected to the console manager. Click **Next** to go to the next page of the Switch History Log. Clicking **Clear** will allow the user to clear the Switch History Log.

The information is described as follows:

Parameter	Description
Sequence	A counter incremented whenever an entry to the Switch's history log is made. The table displays the last entry (highest sequence number) first.
Time	Displays the time in days, hours, and minutes since the Switch was last restarted.
Log Text	Displays text describing the event that triggered the history log entry.

Section 13

Switch Maintenance

Reset

Reboot System

Save Changes

Log Out

Reset

The Reset function has several options when resetting the Switch. Some of the current configuration parameters can be retained while resetting all other configuration parameters to their factory defaults.



NOTE: Only the Reset System option will enter the factory default parameters into the Switch's non-volatile RAM, and then restart the Switch. All other options enter the factory defaults into the current configuration, but do not save this configuration. Reset System will return the Switch's configuration to the state it was when it left the factory

Reset gives the option of retaining the Switch's User Accounts and History Log while resetting all other configuration parameters to their factory defaults. If the Switch is reset using this window, and **Save Changes** is not executed, the Switch will return to the last saved configuration when rebooted.

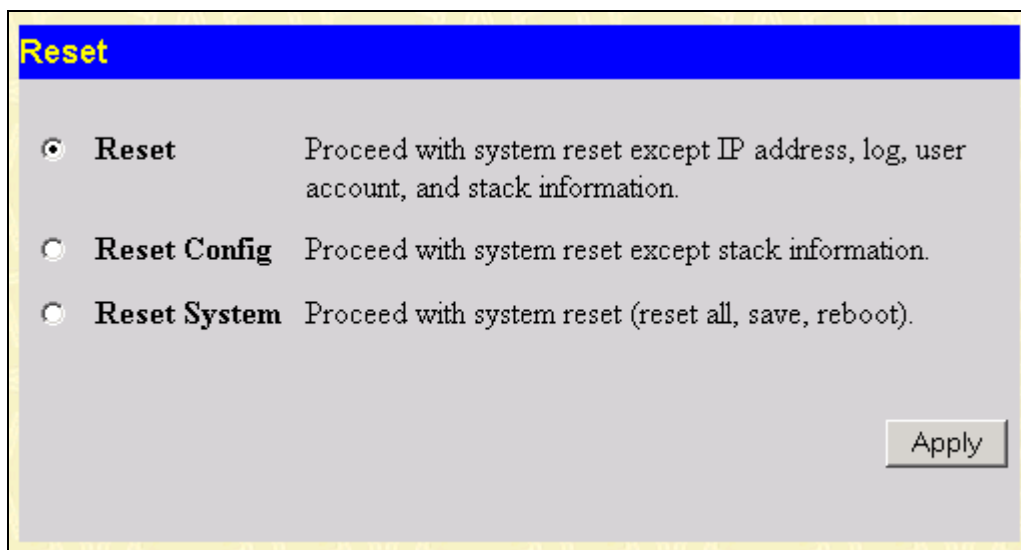

Figure 13- 1. Reset window

Reboot System

In addition, the Reset System option is added to reset all configuration parameters to their factory defaults, save these parameters to the Switch's non-volatile RAM, and then restart the Switch.

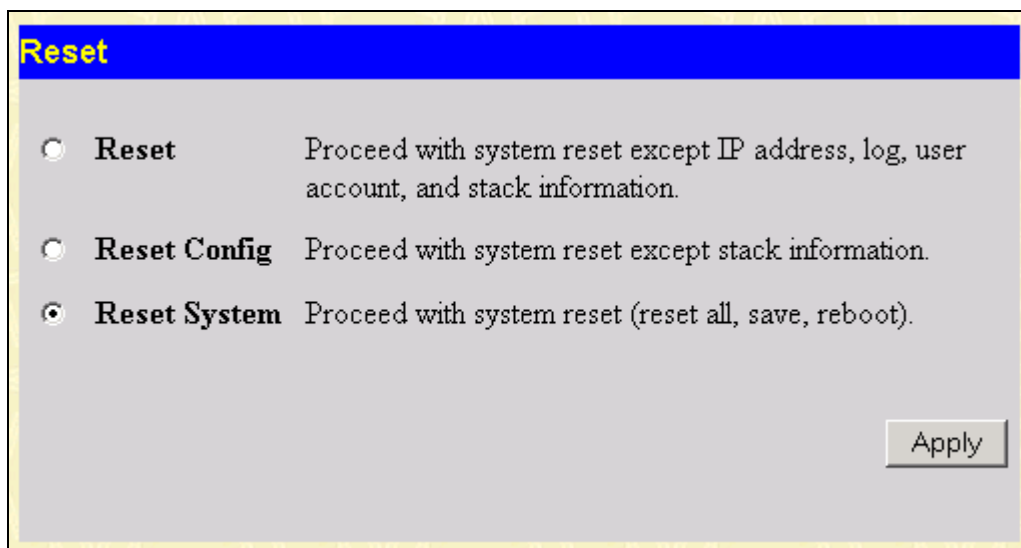

Figure 13- 2.Reset System window

Reboot System

The following window is used to restart the Switch.

All of the configuration information entered from the last time **Save Changes** was executed will be lost. Click the **Reboot** button to restart the Switch.

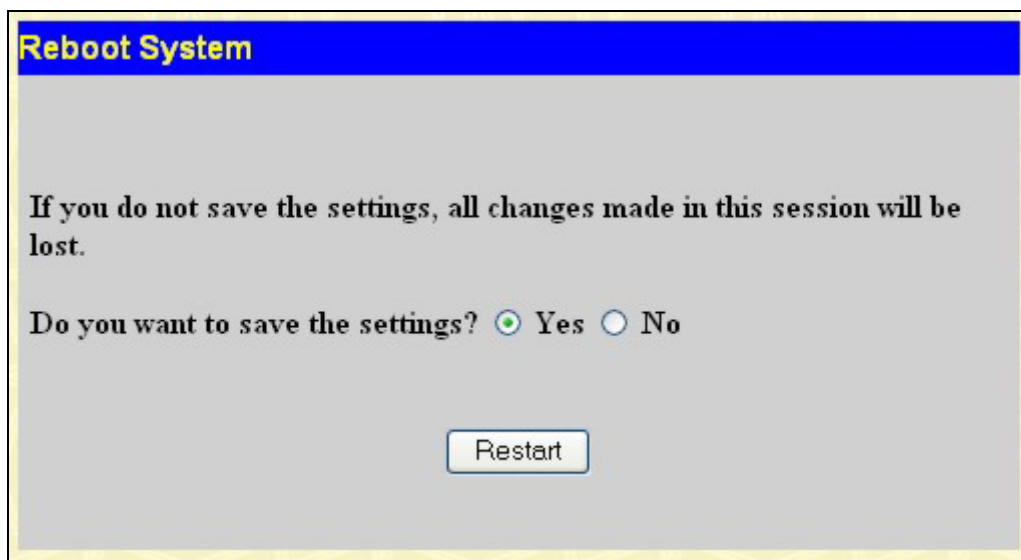

Figure 13- 3. Reboot window

Save Changes

The Switch has two levels of memory; normal RAM and non-volatile or NV-RAM. Configuration changes are made effective by clicking the **Apply** button. When this is done, the settings will be immediately applied to the switching software in RAM, and will immediately take effect.

Some settings, though, require you to restart the Switch before they will take effect. Restarting the Switch erases all settings in RAM and reloads the stored settings from the NV-RAM. Thus, it is necessary to save all setting changes to NV-RAM before rebooting the Switch.

To retain any configuration changes permanently, click the **Save Changes** link. The following window will appear:

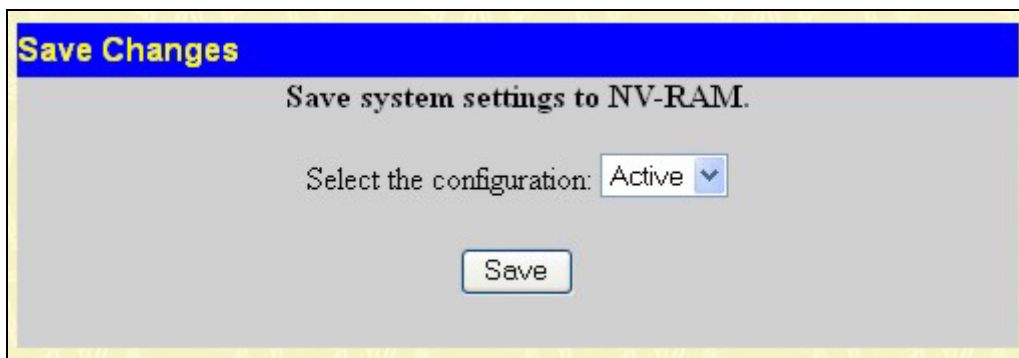

Figure 13- 4. Save Configuration window

The Switch contains two places to save configuration settings in its internal memory. Using the pull down menu, the user may select a place to put the save configurations, marked as *1* or *2*. Also, the user may select the current settings to be the current active configurations of the Switch by selecting *Active*. These settings will be used every time the Switch is rebooted. Clicking the Save button will save the configurations to the place set above. The following dialog box will confirm that the configuration has been saved:

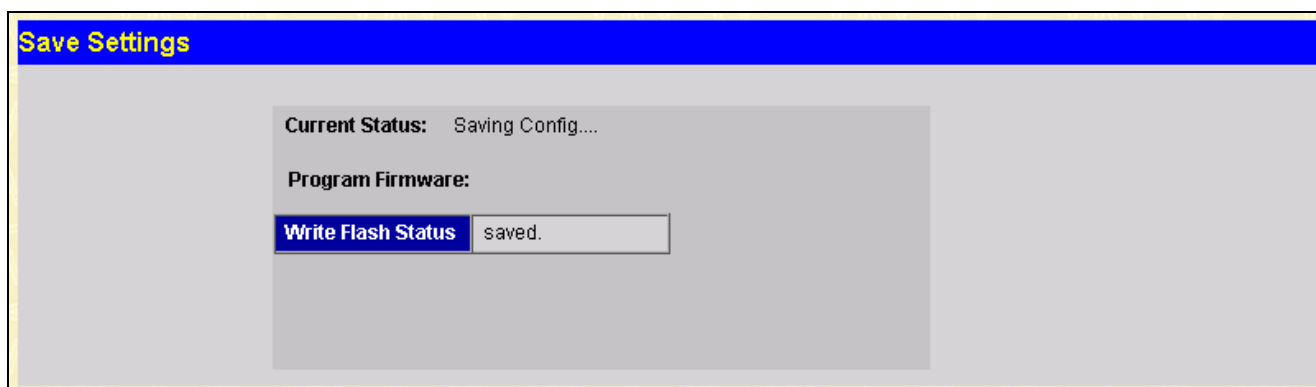

Figure 13- 5. Save Settings dialog box

Logout

Use the Logout page to logout of the Switch's Web-based management agent by clicking on the **Log Out** button.

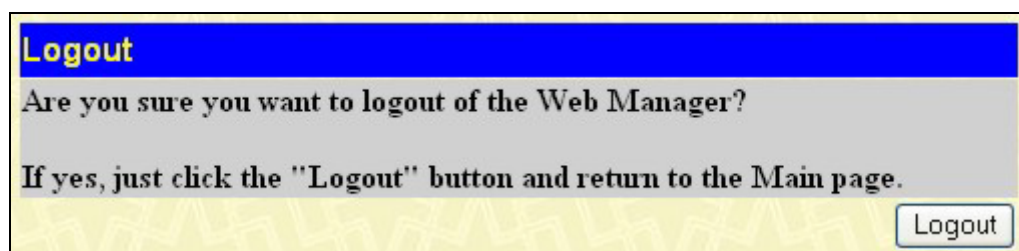

Figure 13- 6. Logout Web Setup window

Appendix A

Technical Specifications

General

Standards	IEEE 802.3 10BASE-T Ethernet IEEE 802.3u 100BASE-TX Fast Ethernet IEEE 802.3ab 1000BASE-T Gigabit Ethernet IEEE 802.3z 1000BASE-T (SFP “Mini GBIC”) IEEE 802.1D Spanning Tree IEEE 802.1W Rapid Spanning Tree IEEE 802.1 P/Q VLAN IEEE 802.1p Priority Queues IEEE 802.3ad Link Aggregation Control IEEE 802.3x Full-duplex Flow Control IEEE 802.3 Nway auto-negotiation IEEE 802.3af Power over Ethernet
Protocols	CSMA/CD
Data Transfer Rates:	Half-duplex Full-duplex
Ethernet	10 Mbps 20Mbps
Fast Ethernet	100Mbps 200Mbps
Gigabit Ethernet	n/a 2000Mbps
Fiber Optic	SFP (Mini GBIC) Support IEEE 802.3z 1000BASE-LX (DEM-310GT transceiver) IEEE 802.3z 1000BASE-SX (DEM-311GT transceiver) IEEE 802.3z 1000BASE-LH (DEM-314GT transceiver) IEEE 802.3z 1000BASE-ZX (DEM-315GT transceiver)
Topology	Star
Network Cables	Cat.5 Enhanced for 1000BASE-T UTP Cat.5, Cat. 5 Enhanced for 100BASE-TX UTP Cat.3, 4, 5 for 10BASE-T EIA/TIA-568 100-ohm screened twisted-pair (STP)(100m)
Number of Ports	24 10/100 Mbps ports (48 for the DES-3852) 2 combo 1000Base-T/SFP ports 2 1000Base-T copper ports

Physical and Environmental

Internal power supply	<p>DES-3828 and DES-3852 Input: 100~240V, AC/1A, 50~60Hz Output: 12V, 5A (MAX),</p> <p>DES-3828P Input: 100~240V, AC/10A, 50~60Hz Output: -50V, -50Vrtn, 7.5A (MAX); 12V, 10.5A (MAX),</p> <p>PoE: Output capacity for whole system: 370W Per Port: 15.4W (Default) Per port → 1~16.8W (Customer can set up)</p> <p>DES-3828DC DC DC Power Input: 48 V,</p>
Power Consumption	<p>24 watts maximum for DES-3828/DES-3828DC 395.2 watts maximum for DES-3828P 47 watts maximum for the DES-3852</p>
DC fans	<p>one 15cm fan for DES-3828/DES-3828DC/DES-3828P/DES-3852 two 8.3cm fans for the DES-3852 one additional 27cm blower for DES-3828P</p>
Operating Temperature	0 - 40°C
Storage Temperature	-40 - 70°C
Humidity	5 - 95% non-condensing
Dimensions	<p>DES-3828/DES3828DC/DES-3852: 441 mm x 310 mm x 44 mm DES-3828P: 441mm x 369mm x 44mm</p>
Weight	<p>DES-3828/DES-3828DC: 4.24kg (9.35lbs) DES-3828P: 6.02kg (13.27lbs) DES-3852: 4.25kg (9.83lbs)</p>
EMI	CE class A, FCC Class A, C-Tick
Safety	CSA International, CB report

Performance

Transmission Method	Store-and-forward
Packet Buffer	32 MB per device
Packet Filtering/Forwarding Rate	<p>14,881 pps (10M port) 148.810 pps (100M port) 1,488,100 pps (1Gbps port)</p>
MAC Address Learning	Automatic update. Supports 16K MAC address.
Priority Queues	8 Priority Queues per port.
Forwarding Table Age Time	Max age: 10-1000000 seconds. Default = 300.

Appendix B

Cables and Connectors

When connecting the Switch to another switch, a bridge or hub, a normal cable is necessary. Please review these products for matching cable pin assignment.

The following diagrams and tables show the standard RJ-45 receptacle/connector and their pin assignments.

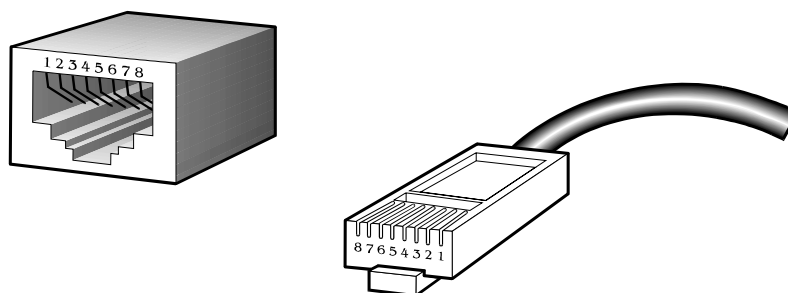

Figure B- 1. The standard RJ-45 port and connector

RJ-45 Pin Assignments		
Contact	MDI-X Port	MDI-II Port
1	RD+ (receive)	TD+ (transmit)
2	RD- (receive)	TD- (transmit)
3	TD+ (transmit)	RD+ (receive)
4	Not used	Not used
5	Not used	Not used
6	TD- (transmit)	RD- (receive)
7	Not used	Not used
8	Not used	Not used

Table B- 1. The standard RJ-45 pin assignments

Appendix C

Cable Lengths

Use the following table to as a guide for the maximum cable lengths.

Standard	Media Type	Maximum Distance
Mini-GBIC	1000BASE-LX, Single-mode fiber module	10km
	1000BASE-SX, Multi-mode fiber module	550m
	1000BASE-LHX, Single-mode fiber module	40km
	1000BASE-ZX, Single-mode fiber module	80km
1000BASE-T	Category 5e UTP Cable	100m
	Category 5 UTP Cable (1000 Mbps)	
100BASE-TX	Category 5 UTP Cable (100 Mbps)	100m
10BASE-T	Category 3 UTP Cable (10 Mbps)	100m

Glossary

1000BASE-LX: A short laser wavelength on multimode fiber optic cable for a maximum length of 550 meters

1000BASE-SX: A long wavelength for a "long haul" fiber optic cable for a maximum length of 10 kilometers

100BASE-FX: 100Mbps Ethernet implementation over fiber.

100BASE-TX: 100Mbps Ethernet implementation over Category 5 and Type 1 Twisted Pair cabling.

10BASE-T: The IEEE 802.3 specification for Ethernet over Unshielded Twisted Pair (UTP) cabling.

aging: The automatic removal of dynamic entries from the Switch Database which have timed-out and are no longer valid.

ATM: Asynchronous Transfer Mode. A connection oriented transmission protocol based on fixed length cells (packets). ATM is designed to carry a complete range of user traffic, including voice, data and video signals.

auto-negotiation: A feature on a port, which allows it to advertise its capabilities for speed, duplex and flow control. When connected to an end station that also supports auto-negotiation, the link can self-detect its optimum operating setup.

backbone port: A port which does not learn device addresses, and which receives all frames with an unknown address. Backbone ports are normally used to connect the Switch to the backbone of your network. Note that backbone ports were formerly known as designated downlink ports.

backbone: The part of a network used as the primary path for transporting traffic between network segments.

bandwidth: Information capacity, measured in bits per second that a channel can transmit. The bandwidth of Ethernet is 10Mbps, the bandwidth of Fast Ethernet is 100Mbps.

baud rate: The switching speed of a line. Also known as line speed between network segments.

BOOTP: The BOOTP protocol allows you to automatically map an IP address to a given MAC address each time a device is started. In addition, the protocol can assign the subnet mask and default gateway to a device.

bridge: A device that interconnects local or remote networks no matter what higher-level protocols are involved. Bridges form a single logical network, centralizing network administration.

broadcast: A message sent to all destination devices on the network.

broadcast storm: Multiple simultaneous broadcasts that typically absorb available network bandwidth and can cause network failure.

console port: The port on the Switch accepting a terminal or modem connector. It changes the parallel arrangement of data within computers to the serial form used on data transmission links. This port is most often used for dedicated local management.

CSMA/CD: Channel access method used by Ethernet and IEEE 802.3 standards in which devices transmit only after finding the data channel clear for some period of time. When two devices transmit simultaneously, a collision occurs and the colliding devices delay their retransmissions for a random amount of time.

data center switching: The point of aggregation within a corporate network where a switch provides high-performance access to server farms, a high-speed backbone connection and a control point for network management and security.

Ethernet: A LAN specification developed jointly by Xerox, Intel and Digital Equipment Corporation. Ethernet networks operate at 10Mbps using CSMA/CD to run over cabling.

Fast Ethernet: 100Mbps technology based on the Ethernet/CD network access method.

Flow Control: (IEEE 802.3z) A means of holding packets back at the transmit port of the connected end station. Prevents packet loss at a congested switch port.

forwarding: The process of sending a packet toward its destination by an internetworking device.

full duplex: A system that allows packets to be transmitted and received at the same time and, in effect, doubles the potential throughput of a link.

half duplex: A system that allows packets to be transmitted and received, but not at the same time. Contrast with full duplex.

IP address: Internet Protocol address. A unique identifier for a device attached to a network using TCP/IP. The address is written as four octets separated with full-stops (periods), and is made up of a network section, an optional subnet section and a host section.

IPX: Internetwork Packet Exchange. A protocol allowing communication in a NetWare network.

LAN - Local Area Network: A network of connected computing resources (such as PCs, printers, servers) covering a relatively small geographic area (usually not larger than a floor or building). Characterized by high data rates and low error rates.

latency: The delay between the time a device receives a packet and the time the packet is forwarded out of the destination port.

line speed: See baud rate.

main port: The port in a resilient link that carries data traffic in normal operating conditions.

MDI - Medium Dependent Interface: An Ethernet port connection where the transmitter of one device is connected to the receiver of another device.

MDI-X - Medium Dependent Interface Cross-over: An Ethernet port connection where the internal transmit and receive lines are crossed.

MIB - Management Information Base: Stores a device's management characteristics and parameters. MIBs are used by the Simple Network Management Protocol (SNMP) to contain attributes of their managed systems. The Switch contains its own internal MIB.

multicast: Single packets copied to a specific subset of network addresses. These addresses are specified in the destination-address field of the packet.

protocol: A set of rules for communication between devices on a network. The rules dictate format, timing, sequencing and error control.

resilient link: A pair of ports that can be configured so that one will take over data transmission should the other fail. See also main port and standby port.

RJ-45: Standard 8-wire connectors for IEEE 802.3 10BASE-T networks.

RMON: Remote Monitoring. A subset of SNMP MIB II that allows monitoring and management capabilities by addressing up to ten different groups of information.

RPS - Redundant Power System: A device that provides a backup source of power when connected to the Switch.

server farm: A cluster of servers in a centralized location serving a large user population.

SLIP - Serial Line Internet Protocol: A protocol, which allows IP to run over a serial line connection.

SNMP - Simple Network Management Protocol: A protocol originally designed to be used in managing TCP/IP internets. SNMP is presently implemented on a wide range of computers and networking equipment and may be used to manage many aspects of network and end station operation.

Spanning Tree Protocol (STP): A bridge-based system for providing fault tolerance on networks. STP works by allowing you to implement parallel paths for network traffic, and ensure that redundant paths are disabled when the main paths are operational and enabled if the main paths fail.

stack: A group of network devices that are integrated to form a single logical device.

standby port: The port in a resilient link that will take over data transmission if the main port in the link fails.

switch: A device, which filters, forwards and floods packets based on the packet's destination address. The switch learns the addresses associated with each switch port and builds tables based on this information to be used for the switching decision.

TCP/IP: A layered set of communications protocols providing Telnet terminal emulation, FTP file transfer, and other services for communication among a wide range of computer equipment.

telnet: A TCP/IP application protocol that provides virtual terminal service, letting a user log in to another computer system and access a host as if the user were connected directly to the host.

TFTP - Trivial File Transfer Protocol: Allows you to transfer files (such as software upgrades) from a remote device using your switch's local management capabilities.

UDP - User Datagram Protocol: An Internet standard protocol that allows an application program on one device to send a datagram to an application program on another device.

VLAN - Virtual LAN: A group of location- and topology-independent devices that communicate as if they are on a common physical LAN.

VLTrunk - Virtual LAN Trunk: A Switch-to-Switch link which carries traffic for all the VLANs on each Switch.

VT100: A type of terminal that uses ASCII characters. VT100 screens have a text-based appearance.

FCC Warning

This equipment has been tested and found to comply with the limits for a Class A digital device, pursuant to Part 15 of the FCC Rules. These limits are designed to provide reasonable protection against harmful interference when the equipment is operated in a commercial environment. This equipment generates, uses, and can radiate radio frequency energy and, if not installed and used in accordance with this manual, may cause harmful interference to radio communications. Operation of this equipment in a residential area is likely to cause harmful interference in which case the user will be required to correct the interference at his own expense.

CE Mark Warning

This is a Class A product. In a domestic environment, this product may cause radio interference in which case the user may be required to take adequate measures.

Warnung!

Dies ist ein Produkt der Klasse A. Im Wohnbereich kann dieses Produkt Funkstörungen verursachen. In diesem Fall kann vom Benutzer verlangt werden, angemessene Massnahmen zu ergreifen.

Precaución!

Este es un producto de Clase A. En un entorno doméstico, puede causar interferencias de radio, en cuyo caso, puede requerirse al usuario para que adopte las medidas adecuadas.

Attention!

Ceci est un produit de classe A. Dans un environnement domestique, ce produit pourrait causer des interférences radio, auquel cas l'utilisateur devrait prendre les mesures adéquates.

Attenzione!

Il presente prodotto appartiene alla classe A. Se utilizzato in ambiente domestico il prodotto può causare interferenze radio, nel cui caso è possibile che l'utente debba assumere provvedimenti adeguati.

BSMI Warning**警告使用者**

這是甲類的資訊產品,在居住的環境中使用時,可能會造成射頻干擾,在這種情況下使用者會被要求採取某些適當的對策

Warranties/Registration

LIMITED WARRANTY

D-Link provides this limited warranty for its product only to the person or entity who originally purchased the product from D-Link or its authorized reseller or distributor. D-Link would fulfill the warranty obligation according to the local warranty policy in which you purchased our products.

Limited Hardware Warranty: D-Link warrants that the hardware portion of the D-Link products described below (“Hardware”) will be free from material defects in workmanship and materials from the date of original retail purchase of the Hardware, for the period set forth below applicable to the product type (“Warranty Period”) if the Hardware is used and serviced in accordance with applicable documentation; provided that a completed Registration Card is returned to an Authorized D-Link Service Office within ninety (90) days after the date of original retail purchase of the Hardware. If a completed Registration Card is not received by an authorized D-Link Service Office within such ninety (90) period, then the Warranty Period shall be ninety (90) days from the date of purchase.

<i>Product Type</i>	<i>Warranty Period</i>
Product (including Power Supplies and Fans)	One (1) Year
Spare parts and pare kits	Ninety (90) days

D-Link’s sole obligation shall be to repair or replace the defective Hardware at no charge to the original owner. Such repair or replacement will be rendered by D-Link at an Authorized D-Link Service Office. The replacement Hardware need not be new or of an identical make, model or part; D-Link may in its discretion may replace the defective Hardware (or any part thereof) with any reconditioned product that D-Link reasonably determines is substantially equivalent (or superior) in all material respects to the defective Hardware. The Warranty Period shall extend for an additional ninety (90) days after any repaired or replaced Hardware is delivered. If a material defect is incapable of correction, or if D-Link determines in its sole discretion that it is not practical to repair or replace the defective Hardware, the price paid by the original purchaser for the defective Hardware will be refunded by D-Link upon return to D-Link of the defective Hardware. All Hardware (or part thereof) that is replaced by D-Link, or for which the purchase price is refunded, shall become the property of D-Link upon replacement or refund.

Limited Software Warranty: D-Link warrants that the software portion of the product (“Software”) will substantially conform to D-Link’s then current functional specifications for the Software, as set forth in the applicable documentation, from the date of original delivery of the Software for a period of ninety (90) days (“Warranty Period”), if the Software is properly installed on approved hardware and operated as contemplated in its documentation. D-Link further warrants that, during the Warranty Period, the magnetic media on which D-Link delivers the Software will be free of physical defects. D-Link’s sole obligation shall be to replace the non-conforming Software (or defective media) with software that substantially conforms to D-Link’s functional specifications for the Software. Except as otherwise agreed by D-Link in writing, the replacement Software is provided only to the original licensee, and is subject to the terms and conditions of the license granted by D-Link for the Software. The Warranty Period shall extend for an additional ninety (90) days after any replacement Software is delivered. If a material non-conformance is incapable of correction, or if D-Link determines in its sole discretion that it is not practical to replace the non-conforming Software, the price paid by the original licensee for the non-conforming Software will be refunded by D-Link; provided that the non-conforming Software (and all copies thereof) is first returned to D-Link. The license granted respecting any Software for which a refund is given automatically terminates.

What You Must Do For Warranty Service:

Registration Card. The Registration Card provided at the back of this manual must be completed and returned to an Authorized D-Link Service Office for each D-Link product within ninety (90) days after the product is purchased and/or licensed. The addresses/telephone/fax list of the nearest Authorized D-Link Service Office is provided in the back of this manual. FAILURE TO PROPERLY COMPLETE AND TIMELY RETURN THE REGISTRATION CARD MAY AFFECT THE WARRANTY FOR THIS PRODUCT.

Submitting A Claim. Any claim under this limited warranty must be submitted in writing before the end of the Warranty Period to an Authorized D-Link Service Office. The claim must include a written description of the Hardware defect or Software nonconformance in sufficient detail to allow D-Link to confirm the same. The original product owner must obtain a Return Material Authorization (RMA) number from the Authorized D-Link Service Office and, if requested, provide written proof of purchase of the product (such as a copy of the dated purchase invoice for the product) before the warranty service is provided. After an RMA number is issued, the defective product must be packaged securely in the original or other suitable shipping package to ensure that it will not be damaged in transit, and the RMA number must be prominently marked on the outside of the package. The packaged product shall be insured and shipped to Authorized D-Link Service Office with all shipping costs prepaid. D-Link may reject or return any product that is not packaged and shipped in strict compliance with the foregoing requirements, or for which an RMA number is not visible from the outside of the package. The product owner agrees to pay D-Link’s reasonable handling and return shipping charges for any product that is not packaged and shipped in accordance with the foregoing requirements, or that is determined by D-Link not to be defective or non-conforming.

What Is Not Covered:

This limited warranty provided by D-Link does not cover:

Products that have been subjected to abuse, accident, alteration, modification, tampering, negligence, misuse, faulty installation, lack of reasonable care, repair or service in any way that is not contemplated in the documentation for the product, or if the model or serial number has been altered, tampered with, defaced or removed;

Initial installation, installation and removal of the product for repair, and shipping costs;

Operational adjustments covered in the operating manual for the product, and normal maintenance;

Damage that occurs in shipment, due to act of God, failures due to power surge, and cosmetic damage; and

Any hardware, software, firmware or other products or services provided by anyone other than D-Link.

Disclaimer of Other Warranties: EXCEPT FOR THE LIMITED WARRANTY SPECIFIED HEREIN, THE PRODUCT IS PROVIDED "AS-IS" WITHOUT ANY WARRANTY OF ANY KIND INCLUDING, WITHOUT LIMITATION, ANY WARRANTY OF MERCHANTABILITY, FITNESS FOR A PARTICULAR PURPOSE AND NON-INFRINGEMENT. IF ANY IMPLIED WARRANTY CANNOT BE DISCLAIMED IN ANY TERRITORY WHERE A PRODUCT IS SOLD, THE DURATION OF SUCH IMPLIED WARRANTY SHALL BE LIMITED TO NINETY (90) DAYS. EXCEPT AS EXPRESSLY COVERED UNDER THE LIMITED WARRANTY PROVIDED HEREIN, THE ENTIRE RISK AS TO THE QUALITY, SELECTION AND PERFORMANCE OF THE PRODUCT IS WITH THE PURCHASER OF THE PRODUCT.

Limitation of Liability: TO THE MAXIMUM EXTENT PERMITTED BY LAW, D-LINK IS NOT LIABLE UNDER ANY CONTRACT, NEGLIGENCE, STRICT LIABILITY OR OTHER LEGAL OR EQUITABLE THEORY FOR ANY LOSS OF USE OF THE PRODUCT, INCONVENIENCE OR DAMAGES OF ANY CHARACTER, WHETHER DIRECT, SPECIAL, INCIDENTAL OR CONSEQUENTIAL (INCLUDING, BUT NOT LIMITED TO, DAMAGES FOR LOSS OF GOODWILL, WORK STOPPAGE, COMPUTER FAILURE OR MALFUNCTION, LOSS OF INFORMATION OR DATA CONTAINED IN, STORED ON, OR INTEGRATED WITH ANY PRODUCT RETURNED TO D-LINK FOR WARRANTY SERVICE) RESULTING FROM THE USE OF THE PRODUCT, RELATING TO WARRANTY SERVICE, OR ARISING OUT OF ANY BREACH OF THIS LIMITED WARRANTY, EVEN IF D-LINK HAS BEEN ADVISED OF THE POSSIBILITY OF SUCH DAMAGES. THE SOLE REMEDY FOR A BREACH OF THE FOREGOING LIMITED WARRANTY IS REPAIR, REPLACEMENT OR REFUND OF THE DEFECTIVE OR NON-CONFORMING PRODUCT.

GOVERNING LAW: This Limited Warranty shall be governed by the laws of the state of California.

Some states do not allow exclusion or limitation of incidental or consequential damages, or limitations on how long an implied warranty lasts, so the foregoing limitations and exclusions may not apply. This limited warranty provides specific legal rights and the product owner may also have other rights which vary from state to state.

Trademarks

Copyright ©2006 D-Link Corporation. Contents subject to change without prior notice. D-Link is a registered trademark of D-Link Corporation/D-Link Systems, Inc. All other trademarks belong to their respective proprietors.

Copyright Statement

No part of this publication may be reproduced in any form or by any means or used to make any derivative such as translation, transformation, or adaptation without permission from D-Link Corporation/D-Link Systems Inc., as stipulated by the United States Copyright Act of 1976.

FCC Warning

This equipment has been tested and found to comply with the limits for a Class B digital device, pursuant to part 15 of the FCC Rules. These limits are designed to provide reasonable protection against harmful interference in a residential installation. This equipment generates, uses and can radiate radio frequency energy and, if not installed and used in accordance with the instructions, may cause harmful interference to radio communications. However, there is no guarantee that interference will not occur in a particular installation. If this equipment does cause harmful interference to radio or television reception, which can be determined by turning the equipment off and on, the user is encouraged to try to correct the interference by one or more of the following measures:

- Reorient or relocate the receiving antenna.
- Increase the separation between the equipment and receiver.
- Connect the equipment into an outlet on a circuit different from that to which the receiver is connected.
- Consult the dealer or an experienced radio/ TV technician for help.

FCC Radiation Exposure Statement

This equipment complies with FCC radiation exposure limits set forth for an uncontrolled environment. This equipment should be installed and operated with minimum 20cm between the radiator and your body.

Subject to the terms and conditions set forth herein, D-Link Systems, Inc. ("D-Link") provides this Limited Warranty:

- Only to the person or entity that originally purchased the product from D-Link or its authorized reseller or distributor, and
- Only for products purchased and delivered within the fifty states of the United States, the District of Columbia, U.S. Possessions or Protectorates, U.S. Military Installations, or addresses with an APO or FPO.

Limited Warranty: D-Link warrants that the hardware portion of the D-Link product described below ("Hardware") will be free from material defects in workmanship and materials under normal use from the date of original retail purchase of the product, for the period set forth below ("Warranty Period"), except as otherwise stated herein.

Limited Lifetime Warranty for the product is defined as follows:

- Hardware: For as long as the original customer/end user owns the product, or five (5) years after product discontinuance, whichever occurs first (excluding power supplies and fans)
- Power supplies and fans: Three (3) Year
- Spare parts and spare kits: Ninety (90) days

The customer's sole and exclusive remedy and the entire liability of D-Link and its suppliers under this Limited Warranty will be, at D-Link's option, to repair or replace the defective Hardware during the Warranty Period at no charge to the original owner or to refund the actual purchase price paid. Any repair or replacement will be rendered by D-Link at an Authorized D-Link Service Office. The replacement hardware need not be new or have an identical make, model or part. D-Link may, at its option, replace the defective Hardware or any part thereof with any reconditioned product that D-Link reasonably determines is substantially equivalent (or superior) in all material respects to the defective Hardware. Repaired or replacement hardware will be warranted for the remainder of the original Warranty Period or ninety (90) days, whichever is longer, and is subject to the same limitations and exclusions. If a material defect is incapable of correction, or if D-Link determines that it is not practical to repair or replace the defective Hardware, the actual price paid by the original purchaser for the defective Hardware will be refunded by D-Link upon return to D-Link of the defective Hardware. All Hardware or part thereof that is replaced by D-Link, or for which the purchase price is refunded, shall become the property of D-Link upon replacement or refund.

Limited Software Warranty: D-Link warrants that the software portion of the product ("Software") will substantially conform to D-Link's then current functional specifications for the Software, as set forth in the applicable documentation, from the date of original retail purchase of the Software for a period of ninety (90) days ("Software Warranty Period"), provided that the Software is properly installed on approved hardware and operated as contemplated in its documentation. D-Link further warrants that, during the Software Warranty Period, the magnetic media on which D-Link delivers the Software will be free of physical defects. The customer's sole and exclusive remedy and the entire liability of D-Link and its suppliers under this Limited Warranty will be, at D-Link's option, to replace the non-conforming Software (or defective media) with software that substantially conforms to D-Link's functional specifications for the Software or to refund the portion of the actual purchase price paid that is attributable to the Software. Except as otherwise agreed by D-Link in writing, the replacement Software is provided only to the original licensee, and is subject to the terms and conditions of the license granted by D-Link for the Software. Replacement Software will be warranted for the remainder of the original Warranty Period and is subject to the same limitations and exclusions. If a material non-conformance is incapable of correction, or if D-Link determines in its sole discretion that it is not practical to replace the non-conforming Software, the price paid by the original licensee for the non-conforming Software will be refunded by D-Link; provided that the non-conforming Software (and all copies thereof) is first returned to D-Link. The license granted respecting any Software for which a refund is given automatically terminates.

Non-Applicability of Warranty: The Limited Warranty provided hereunder for Hardware and Software portions of D-Link's products will not be applied to and does not cover any refurbished product and any product purchased through the inventory clearance or liquidation sale or other sales in which D-Link, the sellers, or the liquidators expressly disclaim their warranty obligation pertaining to the product and in that case, the product is being sold "As-Is" without any warranty whatsoever including, without limitation, the Limited Warranty as described herein, notwithstanding anything stated herein to the contrary.

Submitting A Claim: The customer shall return the product to the original purchase point based on its return policy. In case the return policy period has expired and the product is within warranty, the customer shall submit a claim to D-Link as outlined below:

- The customer must submit with the product as part of the claim a written description of the Hardware defect or Software nonconformance in sufficient detail to allow D-Link to confirm the same, along with proof of purchase of the product (such as a copy of the dated purchase invoice for the product) if the product is not registered.
- The customer must obtain a Case ID Number from D-Link Technical Support at 1-877-453-5465, who will attempt to assist the customer in resolving any suspected defects with the product. If the product is considered defective, the customer must obtain a Return Material Authorization ("RMA") number by completing the RMA form and entering the assigned Case ID Number at <https://rma.dlink.com/>.
- After an RMA number is issued, the defective product must be packaged securely in the original or other suitable shipping package to ensure that it will not be damaged in transit, and the RMA number must be prominently marked on the outside of the package. Do not include any manuals or accessories in the shipping package. D-Link will only replace the defective portion of the product and will not ship back any accessories.
- The customer is responsible for all in-bound shipping charges to D-Link. No Cash on Delivery ("COD") is allowed. Products sent COD will either be rejected by D-Link or become the property of D-Link. Products shall be fully insured by the customer and shipped to **D-Link Systems, Inc., 17595 Mt. Herrmann, Fountain Valley, CA 92708**. D-Link will not be held responsible for any packages that are lost in transit to D-Link. The repaired or replaced packages will be shipped to the customer via UPS Ground or any common carrier selected by D-Link. Return shipping charges shall be prepaid by D-Link if you use an address in the United States, otherwise we will ship the product to you freight collect. Expedited shipping is available upon request and provided shipping charges are prepaid by the customer.

D-Link may reject or return any product that is not packaged and shipped in strict compliance with the foregoing requirements, or for which an RMA number is not visible from the outside of the package. The product owner agrees to pay D-Link's reasonable handling and return shipping charges for any product that is not packaged and shipped in accordance with the foregoing requirements, or that is determined by D-Link not to be defective or non-conforming.

What Is Not Covered: The Limited Warranty provided herein by D-Link does not cover: Products that, in D-Link's judgment, have been subjected to abuse, accident, alteration, modification, tampering, negligence, misuse, faulty installation, lack of reasonable care, repair or service in any way that is not contemplated in the documentation for the product, or if the model or serial number has been altered, tampered with, defaced or removed; Initial installation, installation and removal of the product for repair, and shipping costs; Operational adjustments covered in the operating manual for the product, and normal maintenance; Damage that occurs in shipment, due to act of God, failures due to power surge, and cosmetic damage; Any hardware, software, firmware or other products or services

provided by anyone other than D-Link; and Products that have been purchased from inventory clearance or liquidation sales or other sales in which D-Link, the sellers, or the liquidators expressly disclaim their warranty obligation pertaining to the product. While necessary maintenance or repairs on your Product can be performed by any company, we recommend that you use only an Authorized D-Link Service Office. Improper or incorrectly performed maintenance or repair voids this Limited Warranty.

Disclaimer of Other Warranties: EXCEPT FOR THE LIMITED WARRANTY SPECIFIED HEREIN, THE PRODUCT IS PROVIDED “AS-IS” WITHOUT ANY WARRANTY OF ANY KIND WHATSOEVER INCLUDING, WITHOUT LIMITATION, ANY WARRANTY OF MERCHANTABILITY, FITNESS FOR A PARTICULAR PURPOSE AND NON-INFRINGEMENT. IF ANY IMPLIED WARRANTY CANNOT BE DISCLAIMED IN ANY TERRITORY WHERE A PRODUCT IS SOLD, THE DURATION OF SUCH IMPLIED WARRANTY SHALL BE LIMITED TO NINETY (90) DAYS. EXCEPT AS EXPRESSLY COVERED UNDER THE LIMITED WARRANTY PROVIDED HEREIN, THE ENTIRE RISK AS TO THE QUALITY, SELECTION AND PERFORMANCE OF THE PRODUCT IS WITH THE PURCHASER OF THE PRODUCT.

Limitation of Liability: TO THE MAXIMUM EXTENT PERMITTED BY LAW, D-LINK IS NOT LIABLE UNDER ANY CONTRACT, NEGLIGENCE, STRICT LIABILITY OR OTHER LEGAL OR EQUITABLE THEORY FOR ANY LOSS OF USE OF THE PRODUCT, INCONVENIENCE OR DAMAGES OF ANY CHARACTER, WHETHER DIRECT, SPECIAL, INCIDENTAL OR CONSEQUENTIAL (INCLUDING, BUT NOT LIMITED TO, DAMAGES FOR LOSS OF GOODWILL, LOSS OF REVENUE OR PROFIT, WORK STOPPAGE, COMPUTER FAILURE OR MALFUNCTION, FAILURE OF OTHER EQUIPMENT OR COMPUTER PROGRAMS TO WHICH D-LINK’S PRODUCT IS CONNECTED WITH, LOSS OF INFORMATION OR DATA CONTAINED IN, STORED ON, OR INTEGRATED WITH ANY PRODUCT RETURNED TO D-LINK FOR WARRANTY SERVICE) RESULTING FROM THE USE OF THE PRODUCT, RELATING TO WARRANTY SERVICE, OR ARISING OUT OF ANY BREACH OF THIS LIMITED WARRANTY, EVEN IF D-LINK HAS BEEN ADVISED OF THE POSSIBILITY OF SUCH DAMAGES. THE SOLE REMEDY FOR A BREACH OF THE FOREGOING LIMITED WARRANTY IS REPAIR, REPLACEMENT OR REFUND OF THE DEFECTIVE OR NON-CONFORMING PRODUCT. THE MAXIMUM LIABILITY OF D-LINK UNDER THIS WARRANTY IS LIMITED TO THE PURCHASE PRICE OF THE PRODUCT COVERED BY THE WARRANTY. THE FOREGOING EXPRESS WRITTEN WARRANTIES AND REMEDIES ARE EXCLUSIVE AND ARE IN LIEU OF ANY OTHER WARRANTIES OR REMEDIES, EXPRESS, IMPLIED OR STATUTORY.

Governing Law: This Limited Warranty shall be governed by the laws of the State of California. Some states do not allow exclusion or limitation of incidental or consequential damages, or limitations on how long an implied warranty lasts, so the foregoing limitations and exclusions may not apply. This Limited Warranty provides specific legal rights and you may also have other rights which vary from state to state.

Trademarks: D-Link is a registered trademark of D-Link Systems, Inc. Other trademarks or registered trademarks are the property of their respective owners.

Copyright Statement: No part of this publication or documentation accompanying this product may be reproduced in any form or by any means or used to make any derivative such as translation, transformation, or adaptation without permission from D-Link Corporation/D-Link Systems, Inc., as stipulated by the United States Copyright Act of 1976 and any amendments thereto. Contents are subject to change without prior notice. Copyright 2005 by D-Link Corporation/D-Link Systems, Inc. All rights reserved.

CE Mark Warning: This is a Class A product. In a residential environment, this product may cause radio interference, in which case the user may be required to take adequate measures.

FCC Statement: This equipment has been tested and found to comply with the limits for a Class A digital device, pursuant to part 15 of the FCC Rules. These limits are designed to provide reasonable protection against harmful interference in a commercial installation. This equipment generates, uses, and can radiate radio frequency energy and, if not installed and used in accordance with the instructions, may cause harmful interference to radio communication. However, there is no guarantee that interference will not occur in a particular installation. Operation of this equipment in a residential environment is likely to cause harmful interference to radio or television reception. If this equipment does cause harmful interference to radio or television reception, which can be determined by turning the equipment off and on, the user is encouraged to try to correct the interference by one or more of the following measures:

- Reorient or relocate the receiving antenna.
- Increase the separation between the equipment and receiver.
- Connect the equipment into an outlet on a circuit different from that to which the receiver is connected.
- Consult the dealer or an experienced radio/TV technician for help.

For detailed warranty information applicable to products purchased outside the United States, please contact the corresponding local D-Link office.

Product Registration

Register your D-Link product online at <http://support.dlink.com/register/>

Product registration is entirely voluntary and failure to complete or return this form will not diminish your warranty rights.



D-Link Europe Limited Lifetime Warranty

Dear Customer,

please read below to understand the details of the warranty coverage you have.

Warranty terms for D-LINK xStack products:

All D-Link xStack products* are supplied with a 5 year warranty as standard. To enable the Limited Lifetime Warranty on this product you must register the product, within the first three months of purchase** on the following website: <http://www.dlink.biz/productregistration/>

D-Link will then provide you with a Limited Lifetime Warranty reference number for this product. Please retain your original dated proof of purchase with a note of the serial number, and Limited Lifetime Warranty reference number together with this warranty statement and place each document in a safe location. When you make a warranty claim on a defective product, you may be asked to provide this information.

Nothing in this Limited Lifetime Warranty affects your statutory rights as a consumer. The following are special terms applicable to your Limited Lifetime hardware warranty.

Warranty beneficiary

The warranty beneficiary is the original end user. The original end user is defined as the person that purchases the product as the first owner.

Duration of Limited Lifetime Warranty

As long as the original end-user continues to own or use the product with the following conditions:

- fan and power supplies are limited to a five (5) year warranty only
- in the event of discontinuance of product manufacture, D-Link warranty support is limited to five (5) years from the announcement of discontinuance. If a product is no longer available for replacement, D-Link will issue a product comparable or better to the one originally purchased.

Replacement, Repair or Refund Procedure for Hardware

D-Link or its service center will use commercially reasonable efforts to ship a replacement part within ten (10) working days after receipt of the RMA request. Actual delivery times may vary depending on customer location. D-Link reserves the right to refund the purchase price as its exclusive warranty remedy.

To Receive a Return Materials Authorization (RMA) Number, please visit: <http://service.dlink.biz> and for Italy and Spain, please use: <http://rma.dlink.es> or <http://rma.dlink.it>.



D-Link Limited Lifetime Warranty

Hardware: D-Link warrants the D-Link hardware named above against defects in materials and workmanship for the period specified above. If D-Link receives notice of such defects during the warranty period, D-Link will, at its option, either repair or replace products proving to be defective. Replacement products may be either new or like-new.

Software. D-Link warrants that D-Link software will not fail to execute its programming instructions, for the period specified above, due to defects in material and workmanship when properly installed and used. If D-Link receives notice of such defects during the warranty period, D-Link will replace software media that does not execute its programming instructions due to such defects.

Warranty exclusions

This warranty does not apply if the software, product or any other equipment upon which the software is authorized to be used (a) has been altered, except by D-Link or its authorized representative, (b) has not been installed, operated, repaired, or maintained in accordance with instructions supplied by D-Link (improper use or improper maintenance), (c) has been subjected to abnormal physical or electrical stress, misuse, negligence, or accident; (d) is licensed, for beta, evaluation, testing or demonstration purposes for which D-Link does not charge a purchase price or license fee or (e) defects are caused by force majeure (lightning, floods, war, etc.), soiling, by extraordinary environmental influences or by other circumstances of which D-Link is not responsible.

Disclaimer of warranty

Please note, some countries do not allow the disclaimer of implied terms in contracts with consumers and the disclaimer below may not apply to you.

To the extent allowed by local law, the above warranties are exclusive and no other warranty, condition or other term, whether written or oral, is expressed or implied. D-Link specifically disclaims any implied warranties, conditions and terms of merchantability, satisfactory quality, and fitness for a particular purpose.

To the extent allowed by local law, the remedies in this warranty statement are customer's sole and exclusive remedies. Except as indicated above, in no event will D-Link or its suppliers be liable for loss of data or for indirect, special, incidental, consequential (including lost profit or data), or other damage, whether based in a contract, tort, or otherwise.

To the extent local law mandatorily requires a definition of "Lifetime Warranty" different from that provided here, then the local law definition will supersede and take precedence.

Valid law

The warranty is subject to the valid laws in the country of purchase and is to be interpreted in the warranty terms with the said laws. You may have additional legal rights that are not restricted by this warranty. Nothing in this Limited Lifetime Warranty affects your statutory rights as a consumer.

* DES-6500 series is excluded from the Limited Lifetime Warranty offering and will be supplied with a standard 5 year warranty.

** Failure to register this product within the first three months of purchase [by the first user only] will invalidate the Limited Lifetime Warranty.

Tech Support

Technical Support

You can find software updates and user documentation on the D-Link website.

Tech Support for customers within Australia:

D-Link Technical Support over the Telephone:

1300-766-868

Monday to Friday 8:00am to 8:00pm EST

Saturday 9:00am to 1:00pm EST

D-Link Technical Support over the Internet:

<http://www.dlink.com.au>

email: support@dlink.com.au

Tech Support for customers within New Zealand:

D-Link Technical Support over the Telephone:

0800-900-900

Monday to Friday 8:30am to 8:30pm

Saturday 9:00am to 5:00pm

D-Link Technical Support over the Internet:

<http://www.dlink.co.nz>

email: support@dlink.co.nz

D-Link[®]
Building Networks for People

Technical Support

You can find software updates and user documentation on the D-Link website.

Tech Support for customers within South Eastern Asia and Korea:

D-Link South Eastern Asia and Korea Technical Support over the Telephone:

+65-6895-5355

Monday to Friday 9:00am to 12:30pm, 2:00pm-6:00pm
Singapore Time

D-Link Technical Support over the Internet:

email:support@dlink.com.sg

D-Link[®]
Building Networks for People

Technical Support

You can find software updates and user documentation on the D-Link website.

Tech Support for customers within India
D-Link Technical Support over the Telephone:

+91-22-26526741

+91-22-26526696 –ext 161 to 167

Monday to Friday 9:30AM to 7:00PM

D-Link Technical Support over the Internet:

<http://www.dlink.co.in>

<http://www.dlink.co.in/dlink/drivers/support.asp>

<ftp://support.dlink.co.in>

email: techsupport@dlink.co.in

D-Link®
Building Networks for People

Technical Support

You can find software updates and user documentation on the D-Link website.

D-Link provides free technical support for customers for the duration of the warranty period on this product.

Customers can contact D-Link technical support through our web site or by phone.

Tech Support for customers within the Russia

D-Link Technical Support over the Telephone:

(495) 744-00-99

Monday to Friday 10:00am to 6:30pm

D-Link Technical Support over the Internet

<http://www.dlink.ru>

email: support@dlink.ru

Technical Support

You can find software updates and user documentation on the D-Link website.

Tech Support for customers within the U.A.E & North Africa:

D-Link Technical Support over the Telephone:

(971) 4-391-6480 (U.A.E)

Sunday to Wednesday 9:00am to 6:00pm GMT+4

Thursday 9:00am to 1:00pm GMT+4

D-Link Middle East & North Africa

D-Link Technical Support over the Internet:

<http://support.dlink-me.com>

email: support@dlink-me.com

Tech Support for customers within Israel:

D-Link Technical Support over the Telephone:

(972) 971-5701

Sunday to Thursday 9:00am to 5:00pm

D-Link Technical Support over the Internet:

<http://www.dlink.co.il/forum>

e-mail: support@dlink.co.il

Tech Support for customers within Turkey:

D-Link Technical Support over the Telephone:

(+90) 212-289 56 59

Monday to Friday 9:00am to 6:00pm

D-Link Technical Support over the Internet:

<http://www.dlink.com.tr>

e-mail: turkiye@dlink-me.com

Tech Support for customers within Egypt:

D-Link Technical Support over the Telephone:

(202) 414-4295

Sunday to Thursday 9:00am to 5:00pm

D-Link Technical Support over the Internet:

<http://support.dlink-me.com>

e-mail: amostafa@dlink-me.com

D-Link®
Building Networks for People

Technical Support

You can find software updates and user documentation on the D-Link website.

Tech Support for customers within South Africa and Sub Sahara Region:

D-Link South Africa and Sub Sahara Technical Support over the Telephone:

+27-12-665-2165

08600 DLINK (For South Africa only)

Monday to Friday 8:30am to 9:00pm South Africa Time

D-Link Technical Support over the Internet:

<http://www.d-link.co.za>

[email:support@d-link.co.za](mailto:support@d-link.co.za)

D-Link®
Building Networks for People

Technical Support

You can find updates and user documentation on the D-Link website

Tech Support for Latin America customers:

D-Link Technical Support over the followings Telephones:

Argentina: 0800-666 1442	Monday to Friday 09:00am to 22:00pm
Chile: 800-214 422	Monday to Friday 08:00am to 21:00pm
Colombia: 01800-700 1588	Monday to Friday 07:00am to 20:00pm
Ecuador: 1800-777 711	Monday to Friday 07:00am to 20:00pm
El Salvador: 800-6137	Monday to Friday 06:00am to 19:00pm
Guatemala: 1800-300 0017	Monday to Friday 06:00am to 19:00pm
Panama: 0800-560 0193	Monday to Friday 07:00am to 20:00pm
Peru: 0800-52049	Monday to Friday 07:00am to 20:00pm
Venezuela: 0800-100 3470	Monday to Friday 08:00am to 21:00pm

D-Link Technical Support over the Internet:

www.dlinkla.com

www.dlinklatinamerica.com

email:support@dlink.cl

Tech Support for customers within Brazil:

D-Link Technical Support over the Telephone:

0800-7014104

Monday to Friday 8:30am to 18:30pm

D-Link Technical Support over the Internet:

www.dlinkbrasil.com.br

email:suporte@dlinkbrasil.com.br

D-Link®
Building Networks for People

Техническая поддержка

Обновления программного обеспечения и документация доступны на Интернет-сайте D-Link.

D-Link предоставляет бесплатную поддержку для клиентов в течение гарантийного срока.

Клиенты могут обратиться в группу технической поддержки D-Link по телефону или через Интернет.

Техническая поддержка D-Link:

(095) 744-00-99

Техническая поддержка через Интернет

<http://www.dlink.ru>

email: support@dlink.ru

Asistencia Técnica

D-Link Latin América pone a disposición de sus clientes, especificaciones, documentación y software mas reciente a través de nuestro Sitio Web

www.dlinklatinamerica.com

El servicio de soporte técnico tiene presencia en numerosos países de la Región Latino América, y presta asistencia gratuita a todos los clientes de D-Link, en forma telefónica e internet, a través de la casilla

soporte@dlinkla.com

Soporte Técnico Help Desk Argentina:

Teléfono: 0800-6661442 Lunes a Viernes 09:00 am a 22:00 pm

Soporte Técnico Help Desk Chile:

Teléfono: 800-214422 Lunes a Viernes 08:00 am a 21:00 pm

Soporte Técnico Help Desk Colombia:

Teléfono: 01800-7001588 Lunes a Viernes 07:00 am a 20:00 pm

Soporte Técnico Help Desk Ecuador:

Teléfono: 1800-777 711 Lunes a Viernes 07:00 am a 20:00 pm

Soporte Técnico Help Desk El Salvador:

Teléfono: 800-6137 Lunes a Viernes 06:00 am a 19:00 pm

Soporte Técnico Help Desk Guatemala:

Teléfono: 1800-300 0017 Lunes a Viernes 06:00 am a 19:00 pm

Soporte Técnico Help Desk Panamá:

Teléfono: 0800-560 0193 Lunes a Viernes 07:00 am a 20:00 pm

Soporte Técnico Help Desk Perú:

Teléfono: 0800-52049 Lunes a Viernes 07:00 am a 20:00 pm

Soporte Técnico Help Desk Venezuela:

Teléfono: 0800-1003470 Lunes a Viernes 08:00 am a 21:00 pm

D-Link®
Building Networks for People

Suporte Técnico

Você pode encontrar atualizações de software e documentação de usuário no site da D-Link Brasil www.dlinkbrasil.com.br.

A D-Link fornece suporte técnico gratuito para clientes no Brasil durante o período de vigência da garantia deste produto.

Suporte Técnico para clientes no Brasil:

Telefone

São Paulo (11) 2185-9301

Segunda à sexta

Das 8h30 às 18h30

Demais Regiões do Brasil 0800 70 14 104

E-mail:

email:suporte@dlinkbrasil.com.br

D-Link[®]
Building Networks for People

友冠技術支援

台灣地區用戶可以透過我們的網站，電子郵件或電話與友冠資訊技術支援人員聯絡。

支援服務時間從
週一到週五，上午8:30 a.m. 到 7:00 p.m

Web: <http://www.dlinktw.com.tw/>

FAQ: <http://www.dlinktw.com.tw/support.asp>

Email: dssqa_service@dlinktw.com.tw

Phone: 0800-002-615

如果您是台灣地區以外的用戶，請參考使用手冊中記載的D-Link 全球各地分公司的聯絡資訊取得支援服務。

產品維修與保固相關資訊，請參考友冠資訊網頁說明：
<http://www.dlinktw.com.tw/suppQuick.asp>

Technical Support

You can find software updates and user documentation on the D-Link website.

D-Link provides free technical support for customers within the United States and within Canada for the duration of the warranty period on this product.

U.S. and Canadian customers can contact D-Link technical support through our website, or by phone.

Tech Support for customers within the United States:

D-Link Technical Support over the Telephone:

(888) 843-6100

Hours of Operation: 8:00AM to 6:00PM PST

D-Link Technical Support over the Internet:

<http://support.dlink.com>

email:support@dlink.com

Tech Support for customers within Canada:

D-Link Technical Support over the Telephone:

(800) 361-5265

Monday to Friday 7:30am to 12:00am EST

D-Link Technical Support over the Internet:

<http://support.dlink.ca>

email:support@dlink.ca

Technical Support

You can find software updates and user documentation on the D-Link websites.

D-Link provides free technical support for customers within Canada, the United Kingdom, and Ireland.

Customers can contact D-Link technical support through our websites, or by phone.

For Customers within

The United Kingdom & Ireland:

D-Link UK & Ireland Technical Support over the Telephone:

(08456 12 0003 (United Kingdom)

+1890 886 899 (Ireland)

Lines Open

Monday to Friday 8:00 am to 10:00 pm GMT

Sat & Sun 10.00 am to 7.00 pm GMT

D-Link UK & Ireland Technical Support over the Internet:

<http://www.dlink.co.uk>

<ftp://ftp.dlink.co.uk>

For Customers within Canada:

D-Link Canada Technical Support over the Telephone:

1-800-361-5265 (Canada)

Monday to Friday 7:30 am to 12:00 am EST

D-Link Canada Technical Support over the Internet:

<http://support.dlink.ca>

email: support@dlink.ca

D-Link[®]
Building Networks for People

Technische Unterstützung

Aktualisierte Versionen von Software und Benutzerhandbuch finden Sie auf der Website von D-Link.

D-Link bietet kostenfreie technische Unterstützung für Kunden innerhalb Deutschlands, Österreichs, der Schweiz und Osteuropas.

Unsere Kunden können technische Unterstützung über unsere Website, per E-Mail oder telefonisch anfordern.

Web: <http://www.dlink.de>

E-Mail: support@dlink.de

Telefon: +49 (1805)2787

0,12€/Min aus dem Festnetz der Deutschen Telekom.

Telefonische technische Unterstützung erhalten Sie Montags bis Freitags von 09.00 bis 17.30 Uhr.

Unterstützung erhalten Sie auch bei der Premiumhotline für D-Link Produkte unter der Rufnummer 09001-475767

Montag bis Freitag von 6-22 Uhr und am Wochenende von 11-18 Uhr.

1,75€/Min aus dem Festnetz der Deutschen Telekom.

Wenn Sie Kunde von D-Link außerhalb Deutschlands, Österreichs, der Schweiz und Osteuropas sind, wenden Sie sich bitte an die zuständige Niederlassung aus der

Assistance technique

Vous trouverez la documentation et les logiciels les plus récents sur le site web **D-Link**.

Ceux-ci peuvent contacter le service technique de **D-Link** par notre site internet ou par téléphone.

Support technique destiné aux clients établis en France:

Assistance technique D-Link par téléphone :

0 820 0803 03

Assistance technique D-Link sur internet :

<http://www.dlink.fr>

e-mail : support@dlink.fr

Support technique destiné aux clients établis au
Canada :

Assistance technique D-Link par téléphone :

(800) 361-5265

Lun.-Ven. 7h30 à 21h00 HNE.

Assistance technique D-Link sur internet :

<http://support.dlink.ca>

e-mail : support@dlink.ca

D-Link[®]
Building Networks for People

Asistencia Técnica

Puede encontrar el software más reciente y documentación para el usuario en el sitio web de **D-Link**. **D-Link** ofrece asistencia técnica gratuita para clientes dentro de España durante el periodo de garantía del producto. Los clientes españoles pueden ponerse en contacto con la asistencia técnica de **D-Link** a través de nuestro sitio web o por teléfono.

Asistencia Técnica de D-Link por teléfono:

902 304545

de lunes a viernes desde las 9:00 hasta las 14:00 y de las 15:00 hasta las 18:00

Asistencia Técnica de D-Link a través de Internet:

<http://www.dlink.es>

email: soporte@dlink.es

Supporto tecnico

Gli ultimi aggiornamenti e la documentazione sono disponibili sul sito D-Link.

Supporto tecnico per i clienti residenti in Italia

D-Link Mediterraneo S.r.L.

Via N. Bonnet 6/B 20154 Milano

Supporto Tecnico dal lunedì al venerdì dalle ore
9.00 alle ore 19.00 con orario continuato

Telefono: 02-39607160

URL : <http://www.dlink.it/supporto.html>

Email: tech@dlink.it

Technical Support

You can find software updates and user documentation on the D-Link website.

D-Link provides free technical support for customers within Benelux for the duration of the warranty period on this product.

Benelux customers can contact D-Link technical support through our website, or by phone.

Tech Support for customers within the Netherlands:

D-Link Technical Support over the Telephone:

0900 501 2007

Monday to Friday 8:00 am to 10:00 pm

D-Link Technical Support over the Internet:

www.dlink.nl

Tech Support for customers within Belgium:

D-Link Technical Support over the Telephone:

+32(0)2 717 3248

Monday to Friday 8:00 am to 10:00 pm

D-Link Technical Support over the Internet:

www.dlink.be

Tech Support for customers within Luxemburg:

D-Link Technical Support over the Telephone:

+352 342 080 82 13

Monday to Friday 8:00 am to 10:00 pm

D-Link Technical Support over the Internet:

www.dlink.be

Pomoc techniczna

Najnowsze wersje oprogramowania i dokumentacji użytkownika można znaleźć w serwisie internetowym firmy D-Link.

D-Link zapewnia bezpłatną pomoc techniczną klientom w Polsce w okresie gwarancyjnym produktu.

Klienci z Polski mogą się kontaktować z działem pomocy technicznej firmy D-Link za pośrednictwem Internetu lub telefonicznie.

Telefoniczna pomoc techniczna firmy D-Link:

+49 (1805)-2787

Pomoc techniczna firmy D-Link świadczona przez Internet:

URL: <http://www.dlink.pl>

e-mail: dlink@fixit.pl

Technická podpora

Aktualizované verze software a uživatelských příruček najdete na webových stránkách firmy D-Link.

D-Link poskytuje svým zákazníkům bezplatnou technickou podporu

Zákazníci mohou kontaktovat oddělení technické podpory přes webové stránky, mailem nebo telefonicky

Web: <http://www.dlink.cz/support/>

E-Mail: info@dlink.cz

Telefon: 0224247500

Telefonická podpora je v provozu:

PO- PÁ od 08.00 do 17.00

Technikai Támogatás

Meghajtó programokat és frissítéseket a **D-Link** Magyarország weblapjáról tölthet le.

Telefonon technikai segítséget munkanapokon hétfőtől-csütörtökig 9.00 – 16.00 óráig és pénteken 9.00 – 14.00 óráig kérhet

a **(1) 461-3001** telefonszámon vagy a **support@dlink.hu** emailcímen.

Magyarországi technikai támogatás :

D-Link Magyarország

1074 Budapest, Alsóerdősor u. 6. – R70 Irodaház 1 em.

Tel. : 06 1 461-3001

Fax : 06 1 461-3004

email : support@dlink.hu

URL : http://www.dlink.hu

Teknisk Support

Du kan finne programvare oppdateringer og bruker dokumentasjon på D-Links web sider.

D-Link tilbyr sine kunder gratis teknisk support under produktets garantitid.

Kunder kan kontakte D-Links teknisk support via våre hjemmesider, eller på tlf.

Teknisk Support:

D-Link Teknisk telefon Support:

800 10 610

(Hverdager 08:00-20:00)

D-Link Teknisk Support over Internett:

<http://www.dlink.no>

Teknisk Support

Du finder software opdateringer og bruger-dokumentation på D-Link's hjemmeside.

D-Link tilbyder gratis teknisk support til kunder i Danmark i hele produktets garantiperiode.

Danske kunder kan kontakte D-Link's tekniske support via vores hjemmeside eller telefonisk.

D-Link teknisk support over telefonen:

Tlf. 7026 9040

Åbningstider: kl. 08:00 – 20:00

D-Link teknisk support på Internettet:

<http://www.dlink.dk>

Teknistä tukea asiakkaille Suomessa:

D-Link tarjoaa teknistä tukea asiakkailleen.

Tuotteen takuun voimassaoloajan.

Tekninen tuki palvelee seuraavasti:

Arkisin klo. 9 - 21
numerosta
0800-114 677

Internetin kautta
Ajurit ja lisätietoja tuotteista.
<http://www.dlink.fi>

Sähköpostin kautta
voit myös tehdä kyselyitä.

D-Link[®]
Building Networks for People

Teknisk Support

På vår hemsida kan du hitta mer information om mjukvaru uppdateringar och annan användarinformation.

D-Link tillhandahåller teknisk support till kunder i Sverige under hela garantitiden för denna produkt.

Teknisk Support för kunder i Sverige:

D-Link Teknisk Support via telefon:

0770-33 00 35

Vardagar 08.00-20.00

D-Link Teknisk Support via Internet:

<http://www.dlink.se>

D-Link[®]
Building Networks for People

技术支持

办公地址：北京市朝阳区建国路 71 号惠通时代广场 C1 座
202 室 邮编: 100025

技术支持中心电话：8008868192/(028)85176977

技术支持中心传真：(028)85176948

维修中心地址：北京市朝阳区建国路 71 号惠通时代广场 C1 座
202 室 邮编: 100025

维修中心电话：(010) 58635800

维修中心传真：(010) 58635799

网址：<http://www.dlink.com.cn>

办公时间：周一到周五，早09:00到晚18:00

D-Link[®]
Building Networks for People

International Offices

U.S.A

17595 Mt. Herrmann Street
Fountain Valley, CA 92708, USA
TEL: 1-800-326-1688
URL: www.dlink.com

Canada

2180 Winston Park Drive
Oakville, Ontario, L6H 5W1, Canada
TEL: 1-905-8295033
FAX: 1-905-8295223
URL: www.dlink.ca

Europe (U. K.)

4th Floor, Merit House
Edgware Road, Colindale
London NW9 5AB, U.K.
TEL: 44-20-8731-5555
FAX: 44-20-8731-5511
URL: www.dlink.co.uk

Germany

Schwalbacher Strasse 74
D-65760 Eschborn, Germany
TEL: 49-6196-77990
FAX: 49-6196-7799300
URL: www.dlink.de

France

Le Florilege #.2, Allee de la Fresnerie
78330 Fontenay le Fleury, France
TEL: 33-1-30238688
FAX: 33-1-30238689
URL: www.dlink.fr

Netherlands

Weena 290
3012 NJ Rotterdam, Netherlands
Tel: +31-10-282-1445
FAX: +31-10-282-1331
URL: www.dlink.nl

Belgium

Rue des Colonies 11
B-1000 Brussels, Belgium
Tel: +32(0)2 517 7111
FAX: +32(0)2 517 6500
URL: www.dlink.be

Italy

Via Nino Bonnet n. 6/b
20154 – Milano, Italy
TEL: 39-02-2900-0676
FAX: 39-02-2900-1723
URL: www.dlink.it

Sweden

P.O. Box 15036, S-167 15 Bromma
Sweden
TEL: 46-(0)8564-61900
FAX: 46-(0)8564-61901
URL: www.dlink.se

Denmark

Naverland 2, DK-2600
Glostrup, Copenhagen,
TEL: 45-43-969040
FAX: 45-43-424347
URL: www.dlink.dk

South Africa

Einstein Park II, Block B, 102-106 Witch-Hazel Avenue
Highveld Technopark, Centurion, Gauteng
Republic of South Africa
TEL: 27-12-665-2165
FAX: 27-12-665-2186
URL: www.d-link.co.za

Finland

Latokartanonatie 7A
FIN-00700 Helsinki, Finland
TEL : +358-10-309 8840
FAX: + 358-10-309 8841
URL: www.dlink.fi

Spain

Avenida Diagonal, 593-95, 9th floor
08014 Barcelona, Spain
TEL: 34 93 4090770
FAX: 34 93 4910795
URL: www.dlink.es

Portugal

Rua Fernando Pahlha
50 Edificio Simol
1900 Lisbon, Portugal
TEL: 351 21 8688493
URL: www.dlink.es

Czech Republic

Vaclavske namesti 36, Praha 1
Czech Republic
TEL: +420 (603) 276 589
URL: www.dlink.cz

Switzerland

Glatt Tower, 2.OG CH-8301
Glattzentrum Postfach 2.OG
Switzerland
TEL: +41 (0) 1 832 11 00
FAX:+41 (0) 1 832 11 01
URL: www.dlink.ch

Greece

101, Panagoulis Str. 163-43
Heliopolis, Athens, Greece
TEL: +30 210 9914512
FAX:+30 210 9916902
URL: www.dlink.gr

Luxembourg

Rue des Colonies 11
B-1000 Brussels, Belgium
TEL: +32 (0)2 517 7111
FAX:+32 (0)2 517 6500
URL: www.dlink.be

Poland

Budynek Aurum ul. Walic-w11
PL-00-851
Warszawa, Poland
TEL: +48 (0) 22 583 92 75
FAX:+48 (0) 22 583 92 76
URL: www.dlink.pl

Hungary

R-k-czi-t 70-72
HU-1074
Budapest, Hungary
TEL: +36 (0) 1 461 30 00
FAX:+36 (0) 1 461 30 09
URL: www.dlink.hu

Singapore

1 International Business Park
#03-12 The Synergy, Singapore 609917
TEL: 65-6774-6233
FAX: 65-6774-6322
URL: www.dlink-intl.com

Australia

1 Giffnock Avenue,
North Ryde, NSW 2113, Australia
TEL: 61-2-8899-1800
FAX: 61-2-8899-1868
URL: www.dlink.com.au

India

D-Link House, Kurla Bandra Complex Road,
Off CST Road, Santacruz (East), Mumbai – 400098, India
TEL: 91-022-26526696/56902210
FAX: 91-022-26528914
URL: www.dlink.co.in

Middle East (Dubai)

P.O.Box: 500376, Office No.:103, Building:3
Dubai Internet City, Dubai, United Arab Emirates
TEL:+971-4-3916480
FAX:+971-4-3908881
URL: www.dlink-me.com

Turkey

Ayazaga Maslak Yolu, Erdebil Cevahir Is Merkezi
5/A Ayazaga, Istanbul, Turkiye
TEL: +90 212 289 56 59
FAX: +90 212 289 76 06
URL: www.dlink.com.tr

Egypt

19 El-Shahed Helmy, El Masri, Al-Maza, Heliopolis
Cairo, Egypt
TEL:+202 414 4295
FAX:+202 415 6704
URL: www.dlink-me.com

Israel

11 Hamanofim Street, Ackerstein Towers,
Regus Business Center, P.O.Box 2148,
Hertzelia-Pituch 46120, Israel
TEL: +972-9-9715700
FAX: +972-9-9715601
URL: www.dlink.co.il

Latin America

Isidora Goyechea 2934, Ofcina 702,
Las Condes, Santiago, Chile
TEL: 56-2-583-8950
FAX: 56-2-232-0923
URL: www.dlink.cl

Brasil

Av das Nacoes Unidas, 11857 - 14 - andar - cj 141/142
Brooklin Novo, Sao Paulo - SP – Brazil, CEP 04578-000
TEL: (55 11) 21859300
FAX: (55 11) 21859322
URL: www.dlinkbrasil.com.br

South Africa

Einstein Park II, Block B, 102-106 Witch-Hazel Avenue
Highveld Technopark, Centurion, Gauteng
Republic of South Africa
TEL: 27-12-665-2165
FAX: 27-12-665-2186
URL: www.d-link.co.za

Russia

Grafsky per., 14, floor 6, Moscow, 129626 Russia
TEL: 7-495-744-0099
FAX: 7-495-744-0099 #350
URL: www.dlink.ru

China

No.202, C1 Building, Huitong Office Park,
No.71, Jianguo Road, Chaoyang District, Beijing,
100025, China
TEL +86-10-58635800
FAX: +86-10-58635799
URL: www.dlink.com.cn

Taiwan

No. 289, Sinhu 3rd Rd., Neihu District,
Taipei City 114, Taiwan
TEL: 886-2-6600-0123
FAX: 886-2-6600-1188
URL: www.dlinktw.com.tw

Registration Card

(All Countries and Regions excluding USA)

Print, type or use block letters.

Your name: Mr./Ms _____
 Organization: _____ Dept. _____
 Your title at organization: _____
 Telephone: _____ Fax: _____
 Organization's full address: _____

 Country: _____
 Date of purchase (Month/Day/Year): _____

Product Model	Product Serial No.	* Product installed in type of computer (e.g., Compaq 486)	* Product installed in computer serial No.

(* Applies to adapters only)

Product was purchased from:

Reseller's name: _____
 Telephone: _____ Fax: _____
 Reseller's full address: _____

Answers to the following questions help us to support your product:

1. Where and how will the product primarily be used?

Home Office Travel Company Business Home Business Personal Use

2. How many employees work at installation site?

1 employee 2-9 10-49 50-99 100-499 500-999 1000 or more

3. What network protocol(s) does your organization use ?

XNS/IPX TCP/IP DECnet Others _____

4. What network operating system(s) does your organization use ?

D-Link LANsmart Novell NetWare NetWare Lite SCO Unix/Xenix PC NFS 3Com 3+Open

Banyan Vines Windows NT Windows ME Windows 2000 Windows XP

Others _____

5. What network management program does your organization use ?

D-View HP OpenView/Windows HP OpenView/Unix SunNet Manager Novell NMS

NetView 6000 Others _____

6. What network medium/media does your organization use ?

Fiber-optics Thick coax Ethernet Thin coax Ethernet 10BASE-T UTP/STP

100BASE-TX 100BASE-T4 100VGAnyLAN Others _____

7. What applications are used on your network?

Desktop publishing Spreadsheet Word processing CAD/CAM

Database management Accounting Others _____

8. What category best describes your company?

Aerospace Engineering Education Finance Hospital Legal Insurance/Real Estate Manufacturing

Retail/Chainstore/Wholesale Government Transportation/Utilities/Communication VAR

System house/company Other _____

9. Would you recommend your D-Link product to a friend?

Yes No Don't know yet

10. Your comments on this product?

PLEASE
PLACE STAMP
HERE

TO:

D-Link®