

DAP-3760  
Release 1.00

**Long Distance Wireless Outdoor Bridge**

 **User Manual**

**Business Class Networking**

## Copyright

Copyright © 2009 all rights reserved. No part of this publication may be reproduced, adapted, stored in a retrieval system, translated into any language, or transmitted in any form or by any means without the written permission of the supplier.

## About This Manual

This user manual is intended to guide professional installer to install the DAP-3760 and how to build the infrastructure centered on it. It includes procedures to assist you in avoiding unforeseen problems.

## Conventions

For your attention on important parts, special characters and patterns are used in this manual:



### Note:

- 
- This indicates an important note that you must pay attention to.
- 



### Warning:

- 
- This indicates a warning or caution that you have to abide.
- 

**Bold:** Indicates the function, important words, and so on.

## **Federal Communication Commission Interference Statement**

This equipment has been tested and found to comply with the limits for a Class B digital device, pursuant to Part 15 of the FCC Rules. These limits are designed to provide reasonable protection against harmful interference in a residential installation. This equipment generates uses and can radiate radio frequency energy and, if not installed and used in accordance with the instructions, may cause harmful interference to radio communications. However, there is no guarantee that interference will not occur in a particular installation. If this equipment does cause harmful interference to radio or television reception, which can be determined by turning the equipment off and on, the user is encouraged to try to correct the interference by one of the following measures:

- Reorient or relocate the receiving antenna.
- Increase the separation between the equipment and receiver.
- Connect the equipment into an outlet on a circuit different from that to which the receiver is connected.
- Consult the dealer or an experienced radio/TV technician for help.

This device complies with Part 15 of the FCC Rules. Operation is subject to the following two conditions: (1) This device may not cause harmful interference, and (2) this device must accept any interference received, including interference that may cause undesired operation.

FCC Caution: Any changes or modifications not expressly approved by the party responsible for compliance could void the user's authority to operate this equipment.

## **FCC Radiation Exposure Statement:**

This equipment complies with FCC radiation exposure limits set forth for an uncontrolled environment. To avoid the possibility of exceeding radio frequency exposure limits, you shall keep a distance of at least 100cm between you and the antenna of the installed equipment. This transmitter must not be co-located or operating in conjunction with any other antenna or transmitter.

**The availability of some specific channels and/or operational frequency bands are country dependent and are firmware programmed at the factory to match the intended destination. The firmware setting is not accessible by the end user.**

## Content

<b>Chapter 1 Introduction .....</b>	<b>10</b>
Introduction .....	10
Appearance.....	10
Key Features.....	11
Typical Applications.....	12
Telemedicine Wireless Broadband Application .....	12
Education Wireless Broadband Application .....	13
<b>Chapter 2 Hardware Installation.....</b>	<b>14</b>
Preparation before Installation .....	14
Professional Installation Required.....	14
Safety Precautions .....	15
Product Package .....	15
Hardware Installation .....	17
Assemble the Mounting Bracket.....	17
Pole Mounting.....	17
Interface Definition .....	19
Connect Up.....	21
Grounding.....	22
Power On.....	23
<b>Chapter 3 Basic Settings .....</b>	<b>25</b>
Factory Default Settings.....	25
System Requirements.....	26
How to Login the Web-based Interface.....	27
Basic System Setup .....	29
Basic Wireless Settings .....	30
<b>Chapter 4 Advanced Settings.....</b>	<b>32</b>
Advanced Wireless Settings .....	32
Bridge Links .....	34

Antenna Alignment Tool.....	35
Link Test.....	37
Wireless Security Settings .....	38
Security Profile Configuration.....	38
<b>Chapter 5 Management .....</b>	<b>40</b>
View DAP-3760 Basic Information.....	40
View Ethernet Traffic Statistics.....	41
View Wireless Statistics .....	42
Connections .....	43
Password .....	44
Remote Management .....	44
Console Settings .....	45
SNMP SETTINGS .....	48
SNTP Information/SNTP Setting.....	49
GPS Coordinate Settings.....	50
Firmware Upload.....	51
Configuration File.....	52
Restore Factory Default Settings.....	52
Log Settings .....	54
Reboot.....	55
<b>Chapter 6 Troubleshooting.....</b>	<b>56</b>

## FIGURE

Figure 1 DAP-3760.....	10
Figure 2 Telemedicine Wireless Broadband.....	12
Figure 3 Campus Wireless Broadband.....	13
Figure 4 Bracket Mounting – Step 1.....	17
Figure 5 Bracket Mounting – Step 2.....	17
Figure 6 Pole Mounting –Step 1.....	18
Figure 7 Pole Mounting – Step 2.....	18
Figure 8 Pole Mounting – Step 3.....	18
Figure 9 Interface Definition.....	19
Figure 10 Detailed View of RS-232 Port.....	20
Figure 11 Warning Label.....	20
Figure 12 Vent.....	21
Figure 13 Connect Up – Step 1.....	22
Figure 14 Connect Up – Step 2.....	22
Figure 15 Connect Up – Step 3.....	22
Figure 16 Connect Up – Step 4.....	22
Figure 17 Grounding.....	23
Figure 18 PoE Connection.....	24
Figure 19 Security Alert.....	27
Figure 20 Login.....	27
Figure 21 Main Page.....	28
Figure 22 Basic Setup.....	29
Figure 23 Basic Wireless Settings.....	30
Figure 24 Advanced Parameters.....	32
Figure 25 Peer-to-Peer Links for CSMA.....	34
Figure 26 Bridge Links for TDMA.....	35
Figure 27 Antenna Alignment Tool.....	36
Figure 28 Link Test.....	37
Figure 30 Security.....	38

Figure 30 System Information .....	40
Figure 31 Ethernet Traffic Statistics.....	41
Figure 32 wireless Statistics .....	42
Figure 33 Connections .....	43
Figure 34 Password.....	44
Figure 35 Remote Management.....	45
Figure 36 PuTTY Configuration 1.....	46
Figure 37 PuTTY Configuration 2.....	47
Figure 38 SSH .....	48
Figure 39 Obtain MIB File.....	48
Figure 40 Time Settings.....	49
Figure 41 Firmware Upload .....	51
Figure 42 Configuration File .....	52
Figure 43 Restore Settings.....	53
Figure 44 Log Settings .....	54
Figure 45 Reboot.....	55



## TABLE

Table 1 PIN Definition .....	20
Table 2 DAP-3760 Factory Default Settings.....	25
Table 3 RSSI-Beep Frequency .....	37
Table 4 Public Software Name and Description.....	57

# Chapter 1 Introduction

## Introduction

Designed for outdoor environment application, the DAP-3760 is a high-performance outdoor-deployable wireless bridge that provides wireless connectivity among multiple network locations. The DAP-3760 has a built-in 23dBi planar antenna that can deliver up to a 40Km connection.

The DAP-3760 supports bridge mode, it allows for local area network (LANs) in different locations (buildings) to be easily interconnected. The DAP-3760 delivers “last mile” broadband connectivity through its PTP and PTMP capabilities.

With high throughput and long-distance transmission, DAP-3760 is an ideal backhaul solution for Carriers, Service Providers and Enterprises!

## Appearance



Figure 1 DAP-3760

## Key Features

- Provide easy installation and high performance wireless connectivity of up to 40km
- IP67 waterproof housing endures almost any harsh environments
- Support Bridge mode
- Support 64/128/152-bit WEP, TKIP and AES Encryption
- Support WMM and Quality of service (QoS) for enhanced performance
- Proprietary Antenna Alignment Tool helps identify the antenna orientation with the best signal strength
- Buzzer design helps to determine the device power initial condition
- Super mode to boost the data rate up to 108Mbps
- Advanced management tools like SNMP and Secure Shell (SSH)
- User-friendly Web, SSH and SNMP-based management interface

# Typical Applications

This section describes the typical applications of the DAP-3760.

## Telemedicine Wireless Broadband Application

The DAP-3760 primary usage is as a relay or bridging technology that may be combined with cost effective solar power solution allowing for telemedicine application in remote and rural environments. The DAP-3760 is able to deliver stable and high performance broadband connectivity for typical telemedicine applications in a Line-of-Sight environment.

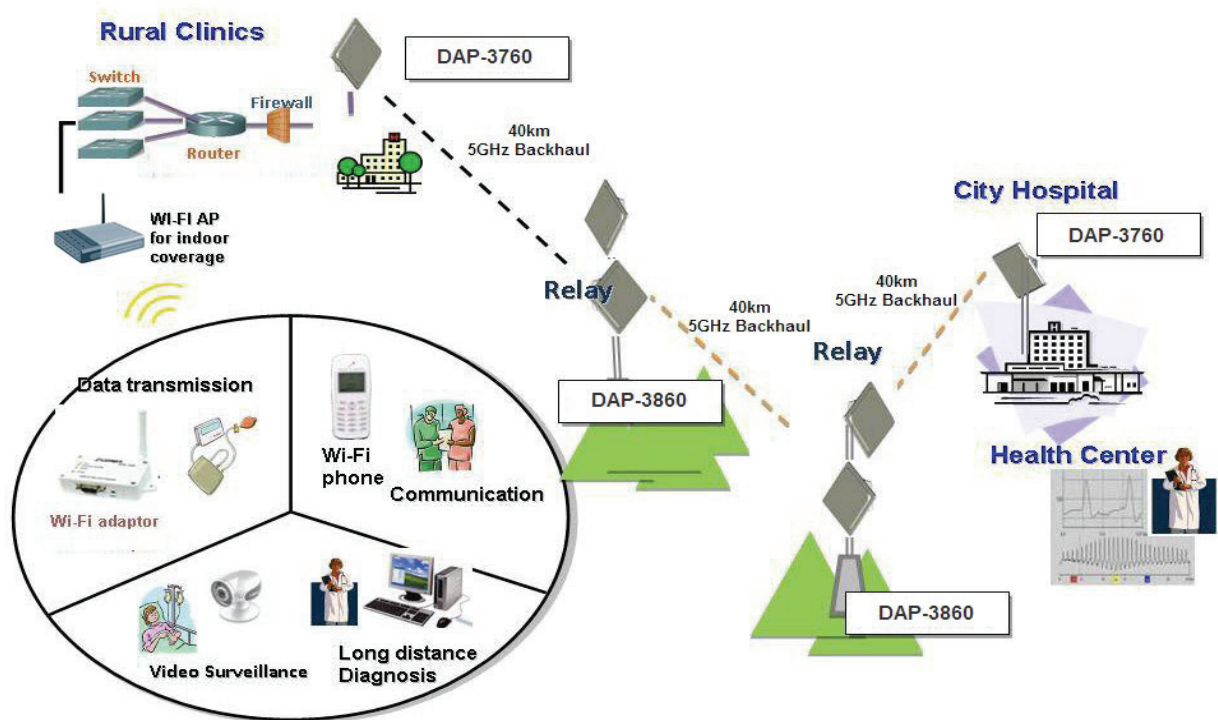
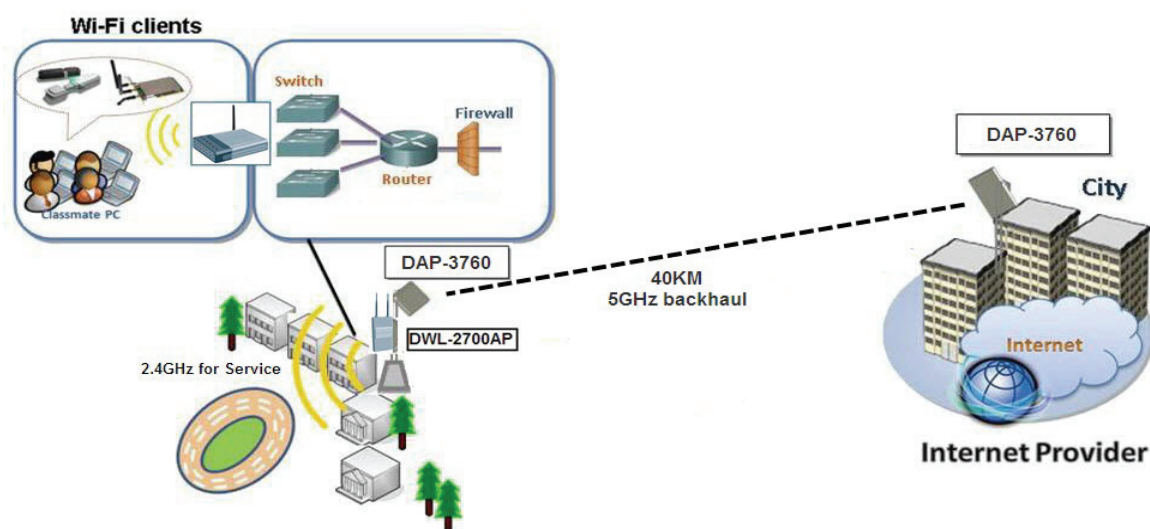

Figure 2 Telemedicine Wireless Broadband

## Education Wireless Broadband Application

School in remote area or rural areas can be provided with broadband connectivity via local Internet service providers. The relay ability of the DAP-3760 allows for multiple hops to be made thus allowing the DAP-3760 to reach more remote LOS locations beyond 40km or to circumvent natural obstructions like mountains.



**Figure 3 Campus Wireless Broadband**

Besides, the DAP-3760 can also be applied into the following environments:

- Cost-effectively provide long distance backhaul for remote areas (e.g. village, oil well, island, mountain and etc.)
- Establish local backhaul for campus, farm and factory
- Provide and access for video streaming or surveillance for industrial and mining enterprises
- Plays as a relay connecting different networks

## Chapter 2 Hardware Installation

This chapter describes safety precautions and product information you have to know and check before installing DAP-3760.

### Preparation before Installation

#### Professional Installation Required

1. Please seek assistance from a professional installer who is well trained in the RF installation and knowledgeable in the local regulations.
2. The DAP-3760 is distributed through distributor and system installer with professional technicians and will not be sold directly through retail store.
3. The equipment shall be installed in RESTRICTED ACCESS LOCATIONS. Access can only be gained by service persons or by users who have been instructed about the reasons for the restrictions applied to the location and about any precautions that shall be taken. Furthermore, access is through the use of a tool or lock and key, or other means of security, and is controlled by the authority responsible for the location.
4. If you are intended to use an external antenna with the DAP-3760, please contact your supplier/installer to ensure that your unit is set for you have fulfilled all the local regulatory requirements. It is the responsibility of the installer/user to check that the equipment as deployed meets local regulatory requirements.

## Safety Precautions

To keep you safe and to install the hardware properly, please read and follow these safety precautions.

- ONLY qualified service personnel should service or disassemble this device;
- When installing the device, note the followings:
  - Do NOT use a metal ladder;
  - Do NOT work on a windy or raining day;
  - Do NOT install, use or service the device during a thunderstorm, as this may cause a remote risk of electric shock from lightning;
  - Wear shoes with rubber soles and heels, rubber gloves, long sleeved shirt or jacket.
  - When the system is operational, avoid standing directly in front of the antenna. Strong RF fields are present when the transmitter is on.
- Ground the device properly with grounding wire to protect against lightning;
- Use ONLY appropriate accessories for the device.
- If the temperatures of the unit surface exceeds the limit, be cautious not to continuous held or

touch the device for a certain period of time.



## Product Package

The product package you have received should contain the following items. If any of them are not included or damaged, please contact your local vendor for support.

- DAP-3760 with integrated 23dBi antenna × 1
- Mounting Kit × 1
- PoE Injector & Power cord × 1
- Grounding Wire with Screw × 1
- Waterproof RJ-45 Connector Kit × 1
- Quick Installation Guide × 1
- Product CD × 1

 **Note:**

- Product CD contains Management Tool, Quick Installation Guide and User Manual!

**Mounting Kit**

- **Wall/Pole Mounting Bracket**

- 1. T-Form Bracket × 1
- 2. Articulation Pole × 1
- 3. Pole Mount Bar × 1

- **Fasteners**

- 4. M8×80 Screw × 2
- M8×90 Screw × 1
- 5. M8 Washer × 3
- 6. M8 Spring Washer × 3
- 7. M8 Nut × 1
- 8. M5×16 Screw × 4
- 9. M5 Washer × 4
- 10. Wood Screw × 4 (for Wall Mount)
- 11. Wall/Gyprock Plug × 4 (for Wall Mount)

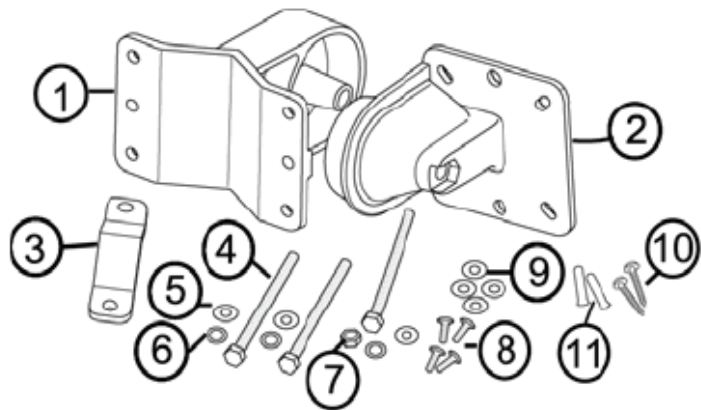

**Waterproof RJ-45 Connector Kit**

- 1. Gland × 1
- 2. Sealing Nut × 1
- 3. Sealing × 1

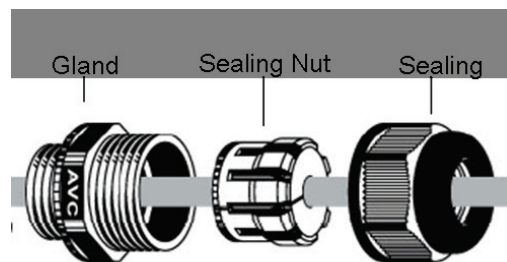



# Hardware Installation

## Assemble the Mounting Bracket

1. Place the main bracket into the seating and use a spanner to fasten the bracket to the DAP-3760 with M5×16 screws ⑧ and M5 washers ⑨ provided in the hardware packets;

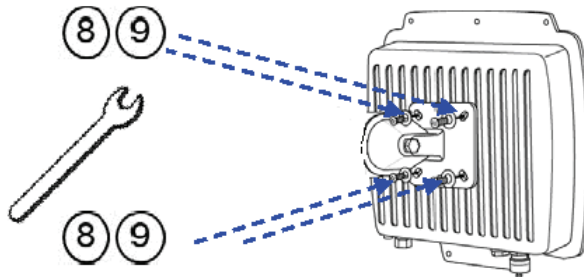

Figure 4 Bracket Mounting – Step 1

2. Assemble the main bracket by placing articulation pole ② to the T-form bracket ① via a M8×90 ④ screw through the insertion axle and fix with the M8 washer ⑤, spring washer ⑥ and M8 nut ⑦;

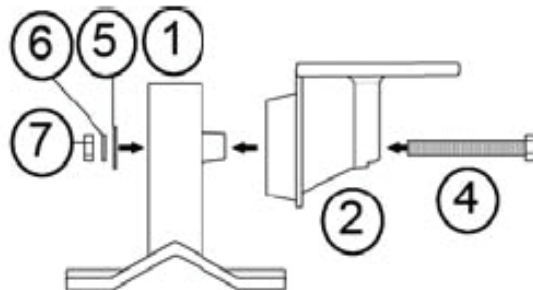
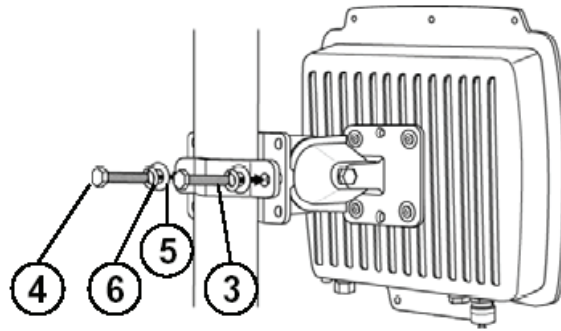

Figure 5 Bracket Mounting – Step 2

## Pole Mounting

1. Install the main bracket and the pole mount bar ③ over the top of the pole by securing the drill holes of the pole mount bar to the main bracket ones and insert two M8×80 ④ screws, spring washers ⑥ and washers ⑤ through the drill holes and main bracket;



**Figure 6 Pole Mounting –Step 1**

2. Fasten two M8×80 screws ④ and washers ⑥ through the drill holes and main bracket with a spanner;

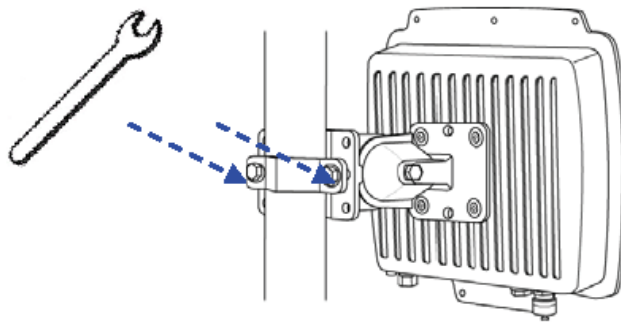

**Figure 7 Pole Mounting – Step 2**

3. Adjust the antenna for appropriate tilt / vertical orientation.

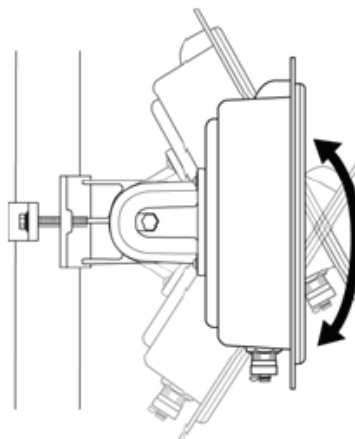

**Figure 8 Pole Mounting – Step 3**

 **Note:**

- 
- The horizontal and vertical beam width of R1 default antenna is about 10 degree respectively.
-

## Interface Definition

The DAP-3760 currently provides two interfaces at the bottom, which are PoE + Data with a black plastic cover and RS-232 with a light gray cover that label “**WARNING! No PoE**”. Among which, a black RJ45 waterproof connector will be provided for the PoE + Data interface.

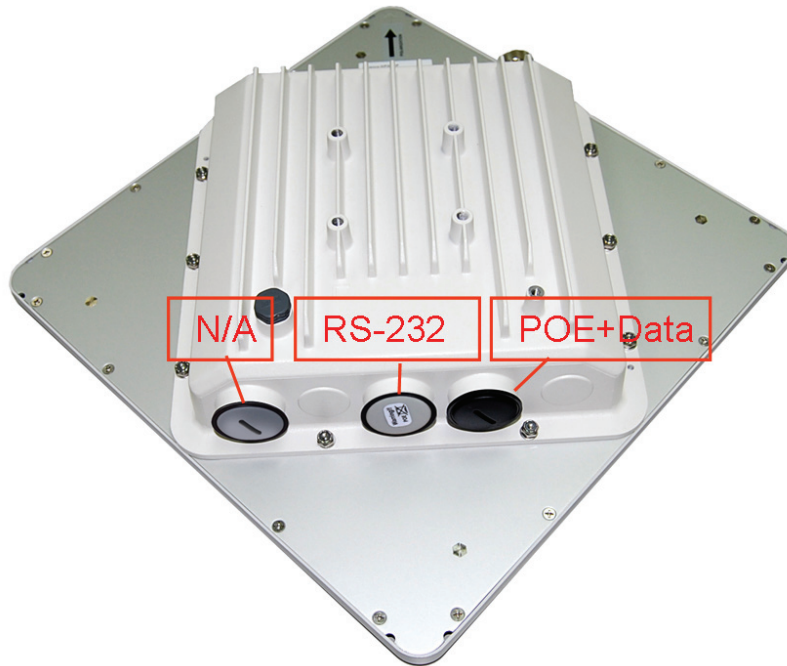

**Figure 9 Interface Definition**

### RS-232

RS-232, which is labeled **COM/RESET**, is used for debugging purposes as well as for hard reset of the DAP-3760. Below you may find the pin definition of the RS-232.

**Table 1 PIN Definition**

Pin Assignment	Name	Description
P1	TXD0	Data Transmit 0
P2	DSR0	Data Set Ready 0
P3	RXD0	Data Receive 0
P4	TXD1	Data Transmit 1
P5	RXD1	Data Receive 1
P6	DTR1	Data Terminal Ready
P7	Hard Reset	Hard reset the unit
P8	GND	Ground

To reset the device, short P7 (Hard Reset) to P8 (GND) for less than 1 second and the system will reset. If P7 (Hard Reset) is shorted to P8 (GND) for over 5 seconds, the DAP-3760 will be reset to the factory default settings.

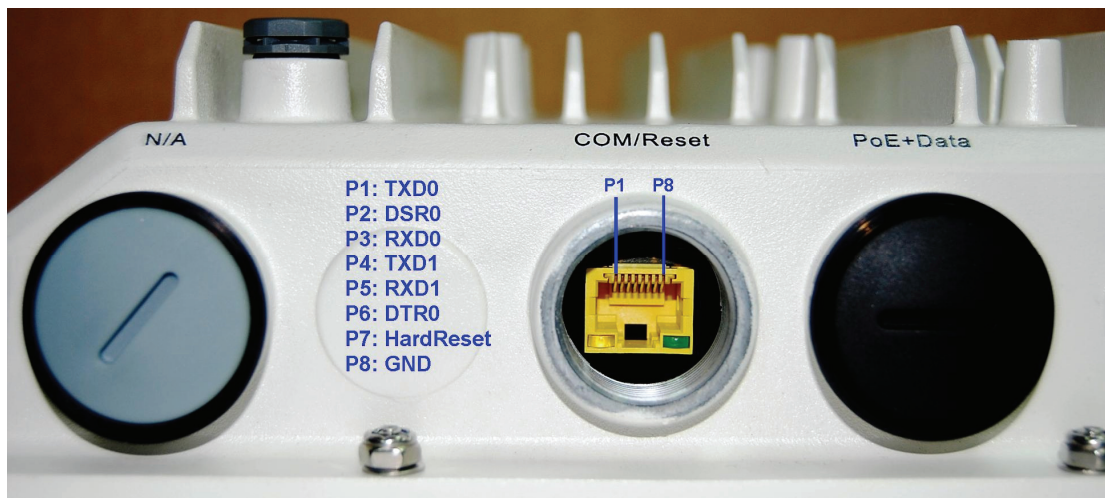

**Figure 10 Detailed View of RS-232 Port**

Below are the views of RS-232 cover and RJ-45 port respectively, please note the label covered on and DO strictly follow the instructions to avoid damaging your equipment!



**Figure 11 Warning Label**

 **Warning:**

- Do NOT connect PoE powered Ethernet cable to the RS-232 port; otherwise the port may burnout!

- If RS-232 cable is used outdoor, please DO add a surge protector to protect the equipment circuit!
  - Strongly recommend to add a lightning arrester on the RS-232 port to prevent from lightning attack!
- 

## Vent

The vent is designed to exclude vapors and moisture out of the unit as well as repel water, dust, and dirt by the specially designed membrane, thereby preventing the DAP-3760 from electric malfunctioning.

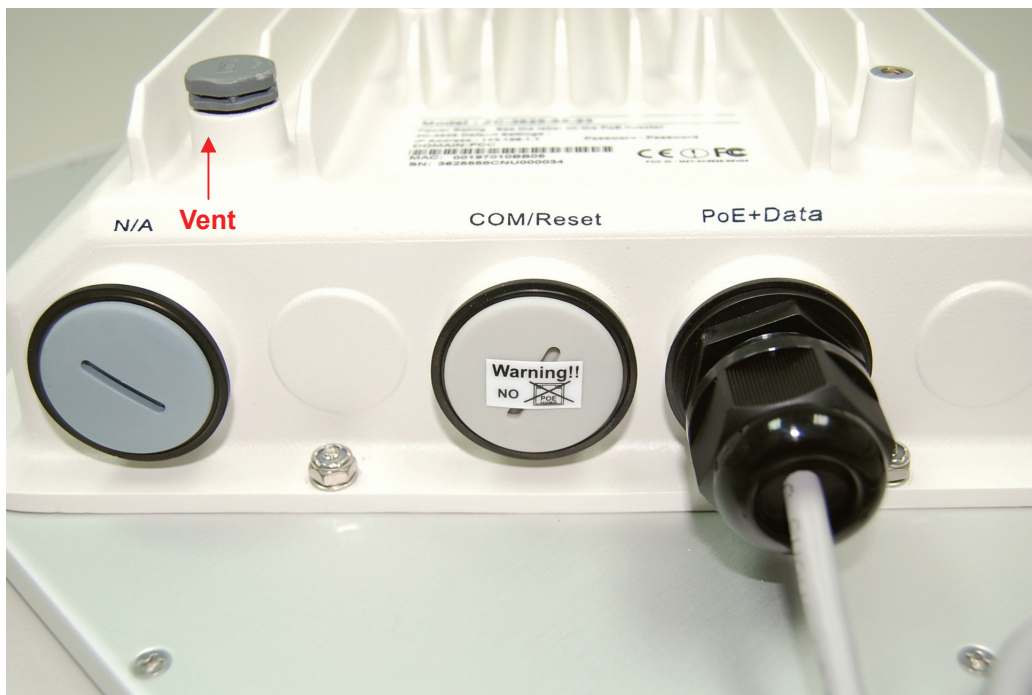

Figure 12 Vent

## Connect Up

Before installing the Ethernet cable with a waterproof RJ-45 connector, it is recommended that the Cat-5 RJ-45 coaxial cable be used for the DAP-3760 to power PoE connector.

1. To connect to the hole labeled **PoE+Data**, open the black cover in advance by using a coin or a slotted screwdriver and then screw in the body of the gland and tighten.



**Figure 13 Connect Up – Step 1**

2. Slide the sealing nut to the RJ-45 cable from its middle breach and then insert the sealing into the cable.

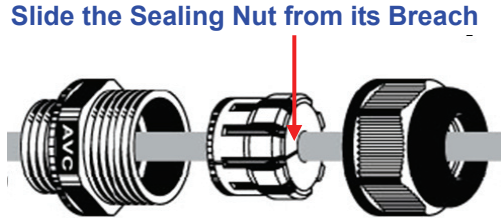

**Figure 14 Connect Up – Step 2**

3. Insert the RJ-45 connector and make sure that the locking tab snaps home.

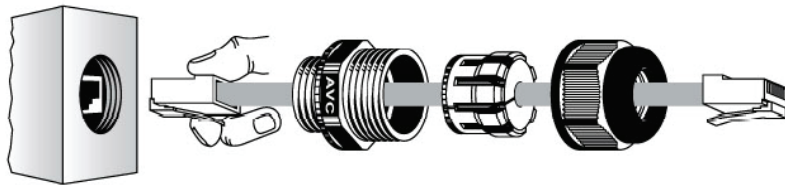

**DAP-3760 RJ-45 Port**

**Figure 15 Connect Up – Step 3**

4. Screw the sealing on the gland and tighten.



**Figure 16 Connect Up – Step 4**

## Grounding

The DAP-3760 is shipped with a grounding wire. The unit must be properly grounded to protect against power surges. The grounding point can be found on the bottom of the unit. It is supplied with an appropriate grounding lug for attachment to the ODU.

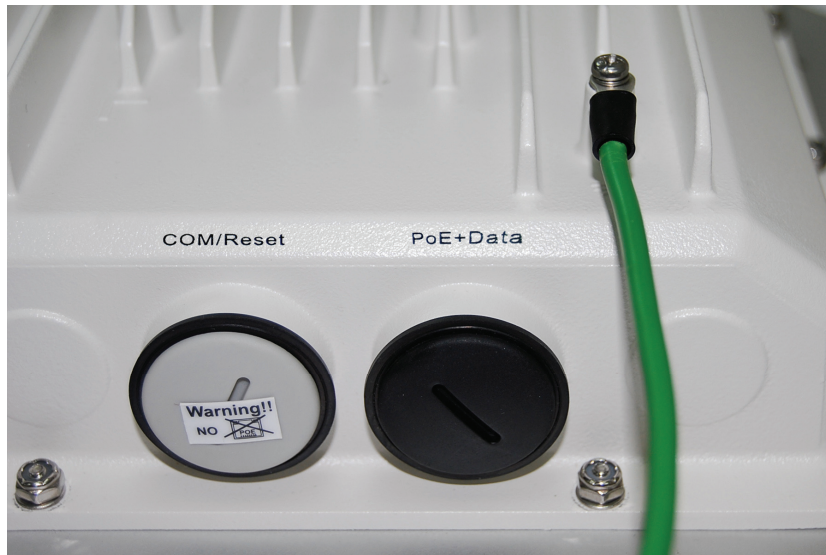

Figure 17 Grounding

## Power On

To power up the DAP-3760, follow the steps bellow:

1. Plug a user-supplied Cat-5 Ethernet cable from your wired LAN (or a computer) into the power injector RJ-45 jack (**DATA IN**);
2. Plug a user-supplied Cat-5 Ethernet cable from the DAP-3760 into the power injector RJ-45 jack (**P+DATA OUT**);
3. Connect the power module to the power injector and plug the AC cord into an AC power receptacle;
4. After being powered on, the device will send out the beep sound lasting about 1.5 seconds, informing you that the DAP-3760 is powered up! Wait about 60 seconds the system will be initialized and start working.



**Figure 18 PoE Connection**

 **Warning:**

- Make sure PoE is correctly connected to the RJ-45 port on the DAP-3760 labeled PoE+Data, otherwise the extender will be severely damaged!





## Chapter 3 Basic Settings

### Factory Default Settings

We'll elaborate the DAP-3760 factory default settings. You can re-acquire these parameters by default. If necessary, please refer to the ["Restore Factory Default Settings"](#).

**Table 2 DAP-3760 Factory Default Settings**

Features		Factory Default Settings
Username		admin
Password		Null
Device Name		DAP-3760
Mode		Bridge (CSMA)
Ethernet Data Rate		AUTO
LAN	IP Address	192.168.0.50
	Subnet Mask	255.255.255.0
	Gateway	0.0.0.0
	Primary DNS Server	0.0.0.0
	Secondary DNS Server	0.0.0.0
Dynamic(DHCP)		Disable
Spanning Tree		Disable
Wireless Band		802.11a
Channel/Frequency		149/5.745GHz (CE: 100/5.5GHz)
Data Rate		Best
Bandwidth		20MHz
WMM		Enable
Super Mode		Disable
RTS Threshold (byte)		2346
Fragmentation Length (byte)		2346
Distance in Meters		10000
Security		Open System
Encryption		None
SSH (Secure Shell)		Enable
SNMP Settings	Enable/Disable	Disable
	Public Community String	Public
	Private Community String	Private
	Trap Server IP	0.0.0.0

## System Requirements

Before configuration, please make sure your system meets the following requirements:

- A computer coupled with 10/ 100 Base-TX adapter;
- Configure the computer with a static IP address of 192.168.0.x, as the default IP address of DAP-3760 is 192.168.0.50, X can not be 0, 50, nor 255;
- A Web browser on PC for configuration such as Microsoft Internet Explorer 6.0 or above, Netscape or Firefox.

## How to Login the Web-based Interface

The DAP-3760 provides you with user-friendly Web-based management tool.

- Open IE and enter the default IP address (Default: **192.168.0.50**) of DAP-3760 into the address field.

A Security Alert window may popup as below, due to browser's security trusted sites. You may choose to continue to the login webpage.

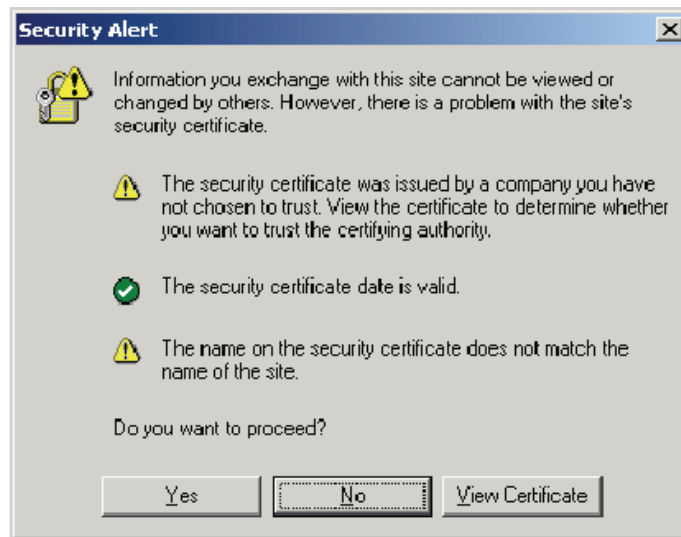

Figure 19 Security Alert

- Click “Yes” will usher you into the login page:

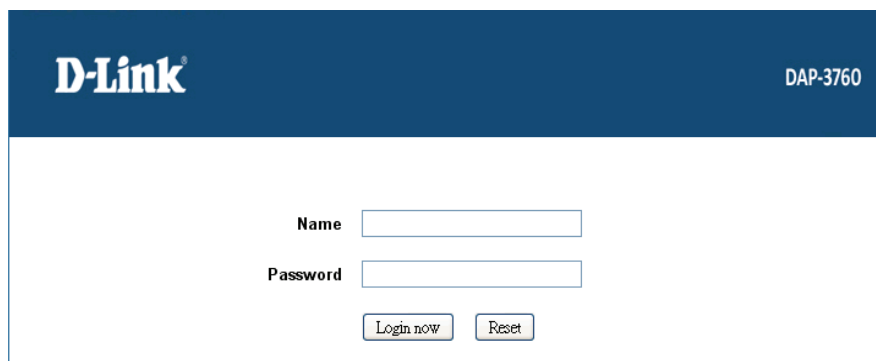

Figure 20 Login

- Enter the username (Default: **admin**) and password (Default: **Null**) respectively and click “Login Now” to login the main page of DAP-3760. As you can see, this management interface provides four main options in the black bar above, which are System, Wireless, Status and Administrator Settings.

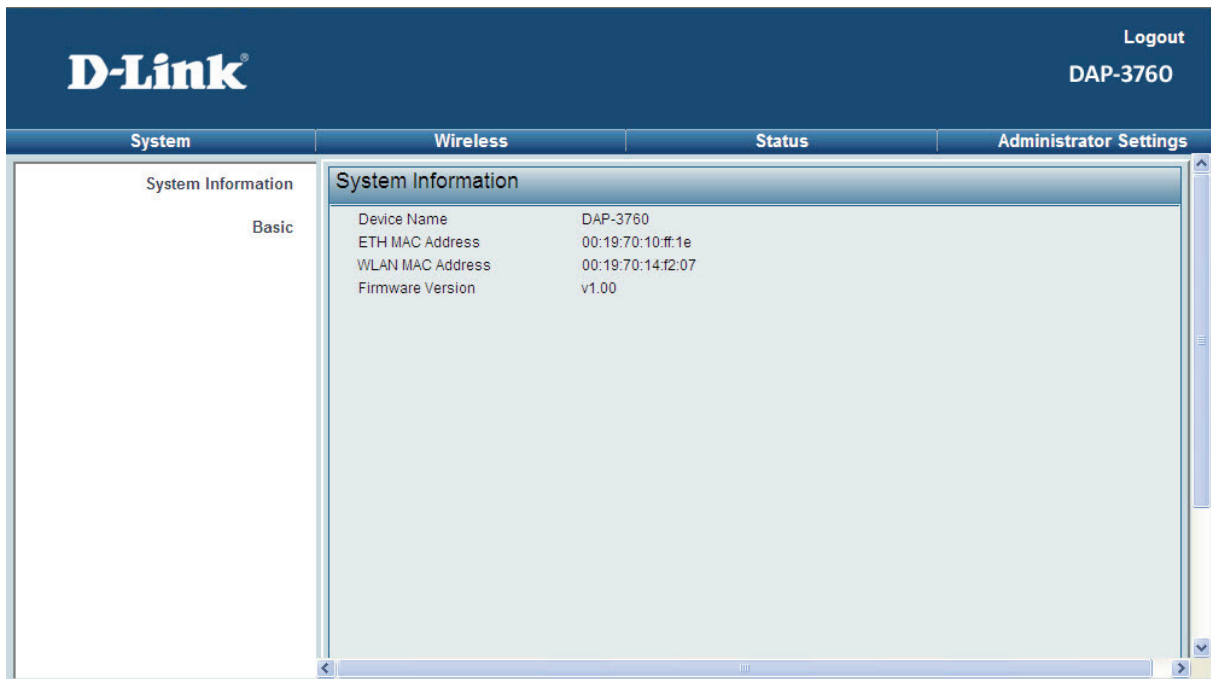

Figure 21 Main Page

 **Note:**

- 
- The username and password are case-sensitive, and the password is no more than 19 characters!
-

## Basic System Setup

For users who use this device for the first time, it is recommended that you begin configuration from “Basic” in “System” shown below:

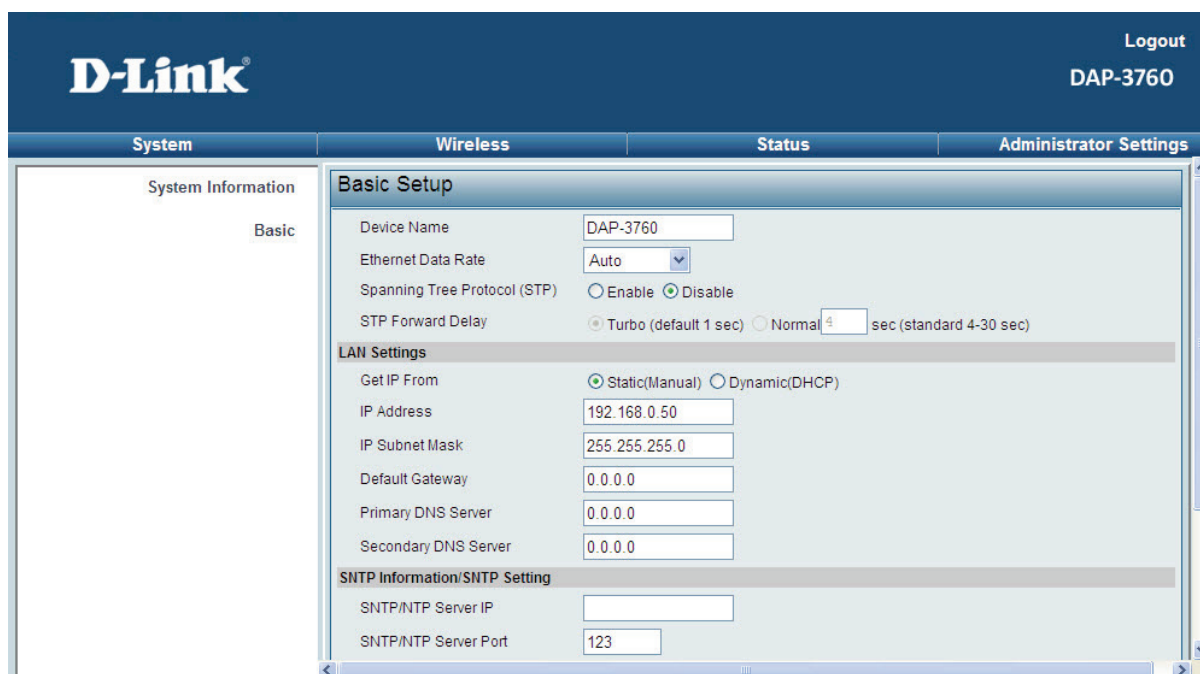

Figure 22 Basic Setup

- **Device Name**

Specify the device name, which is composed of no more than 15 characters with (0-9), (A-Z), (a-z) or (-).

- **Ethernet Data rate**

Specify the transmission rate of data.

- **IP Address**

If you select “**Static (Manual)**”, you have to specify a static IP address, subnet mask, default gateway and DNS server for your local area network which connects to the LAN port of DAP-3760. Make sure the specified IP address is unique on your network in order to prevent IP conflict.

- **Dynamic(DHCP)**

Enable “**Dynamic**” to allow the DHCP server within your local area network to assign an IP address automatically.

- **Spanning Tree Protocol (STP)**

Spanning Tree Protocol is a link management protocol for RCP bridges which provides path redundancy while preventing loops in a network. STP allows only one active path at a time between the RCP bridges but establish the redundant link as a backup if the initial link fails.

- **STP Forward Delay**

STP Forward Delay is the time spent in detecting and learning network tree topology state before entering the forward state. Default time value is 1 sec. Select Normal if you would like to modify the parameter (4-30 seconds).

## Basic Wireless Settings

Open “Radio” in “Wireless” as below to make basic wireless configuration.

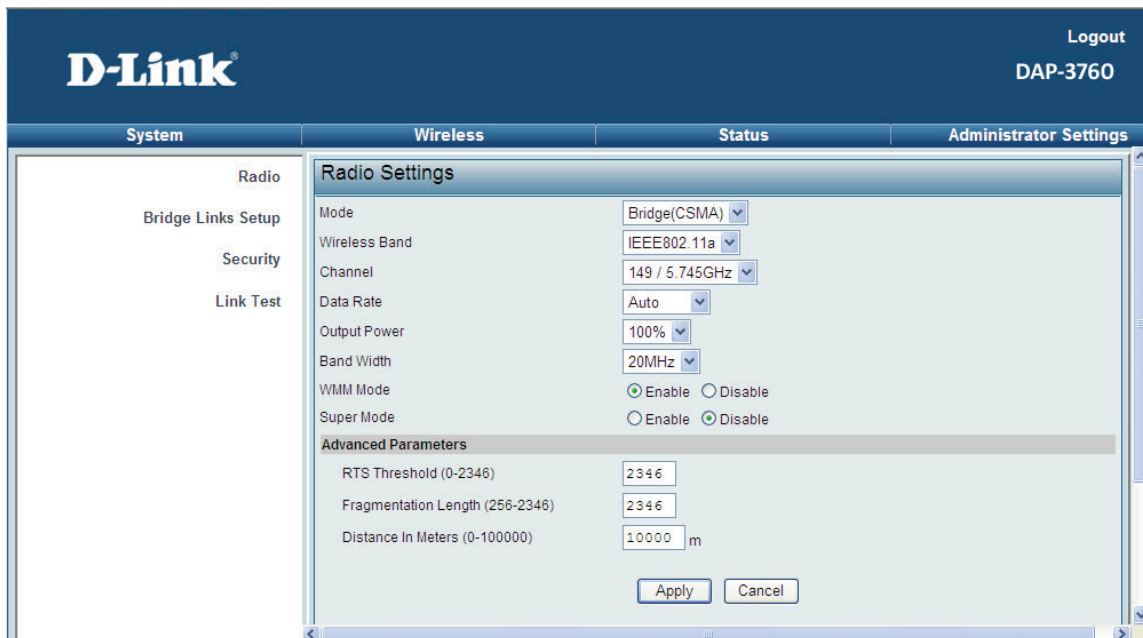

Figure 23 Basic Wireless Settings

- **Mode**

**Bridge (CSMA):** The DAP-3760 connects to another wireless device within the same networking program using CSMA protocol. CSMA ensures that only one node is transmitting on the network at any one time. Under this mode, both PTP and PTMP are available. It is highly recommended to use this mode when the distance between two nodes is less than 20km.

**Bridge (TDMA):** The DAP-3760 connects to another wireless device within the same networking program using TDMA protocol. TDMA divides each cellular channel into multiple time slots to increase the amount of data that can be carried; hence increase the throughput. Under this mode, only PTP is available and is suggested to use when the distance between the two DAP-3760s is greater than

20km.

- **Wireless Band**

The DAP-3760 can only communicate with wireless devices of 802.11a.

- **Channel/Frequency**

Channel varies much as the available band differs from country to country. Select a proper operating channel in the drop-down list according to your situation.

- **Data Rate**

Usually “**Best**” is preferred. Under this rate, the DAP-3760 will automatically select the highest available rate to transmit. In some cases, however, like where there is no great demand for speed, you can have a relatively-low data rate for compromise of a long distance.

- **Band Width**

Four levels are available: 20MHz and 40MHz. Among them, 40MHz can enhance the data rate more effectively, but will take more bandwidth, thus cause possible interference.

- **WMM**

WMM (Wi-Fi Multimedia) is a subset of 802.11e. It allows wireless communication to define a priority limit on the basis of data type, thus those time-sensitive data, like video/audio data, may own a higher priority than common one. To enable WMM, the wireless client should support it.

- **Super Mode**

Super mode is an effective way to enhance performance. It can boost the transmission data rate up to 108Mbps. To enable Super Mode, the remote DAP-3760 should enable the function as well.

## Chapter 4 Advanced Settings

### Advanced Wireless Settings

Open “Radio” in “Wireless” and turn to “Advanced Parameters” at the bottom to make advanced wireless settings.



Figure 24 Advanced Parameters

- **RTS Threshold**

The DAP-3760 sends RTS (Request to Send) frames to certain receiving station and negotiates the sending of a data frame. After receiving an RTS, that STA responds with a CTS (Clear to Send) frame to acknowledge the right to start transmission. The setting range is 0 to 2346 in byte.

- **Fragmentation Length**

Specify the maximum size in byte for a packet before data is fragmented into multiple packets. Setting it too low may result in poor network performance. Leave it at its default of 2346 is recommended.

- **Distance in Meters**

To decrease the chances of data retransmission at long distance, DAP-3760 can auto adjust proper ACK timeout value by specifying distance of the two nodes. Default distance is 10Km. This is only useful for CSMA mode.



 **Note:**

- 
- We strongly recommended you leave most advanced settings at their defaults except Distance in Meters; any modification on them may negatively impact the performance of your wireless network.
-

## Bridge Links

Open “**Bridge Links Setup**” in “**Wireless**”. **Bridge** Links allow establishing PTP or PTMP connectivity with as most four remote wireless devices, this feature only available under **Bridge** (CSMA) mode.

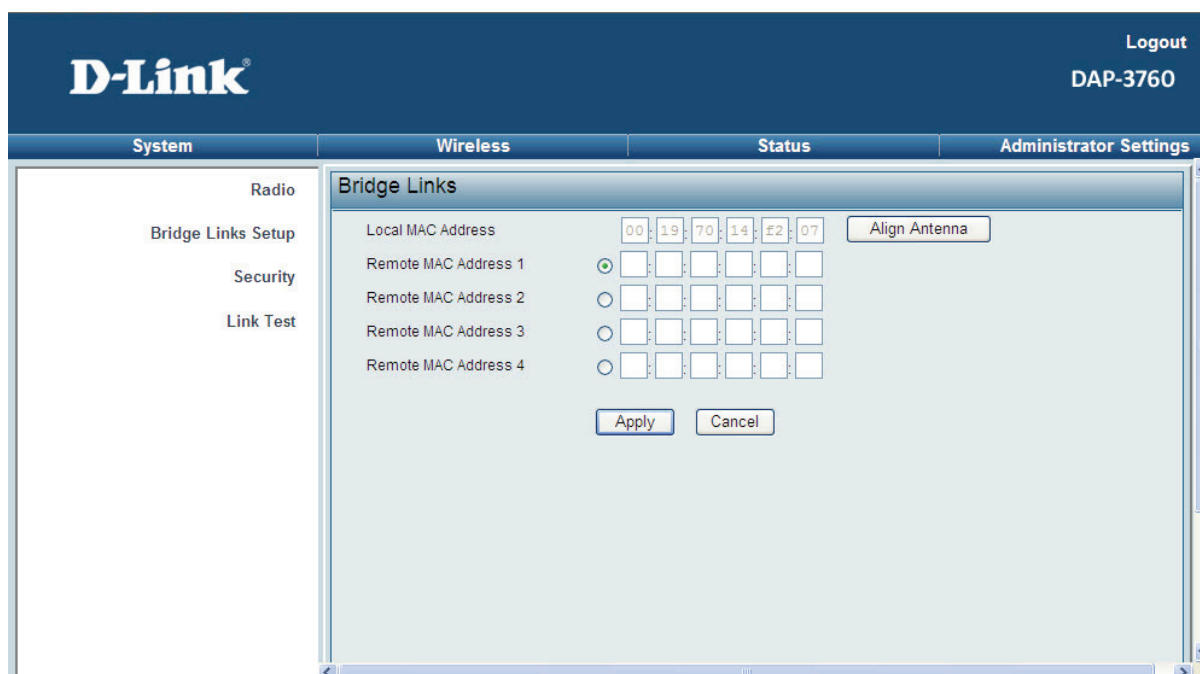

**Figure 25 Peer-to-Peer Links for CSMA**

- To setup **Bridge** link, first login the Web-based interface of remote DAP-3760, open “**System Information**” in “**System**” and record the wireless MAC address of it.
- Then, login the Web-based interface of local DAP-3760 and open “**Bridge Setup**” in “**Wireless**”, input the WLAN MAC address of the remote one to “**Remote MAC Address 1**” field and click “**Apply**”;
- To check whether the link has been successfully established, you may use ping to justify.

The other way to establish PTMP connectivity is to setup the same group id under “**Radio**” in “**Wireless**”. This feature only available under Bridge (TDMA) mode and only devices with the same Group ID can communicate.

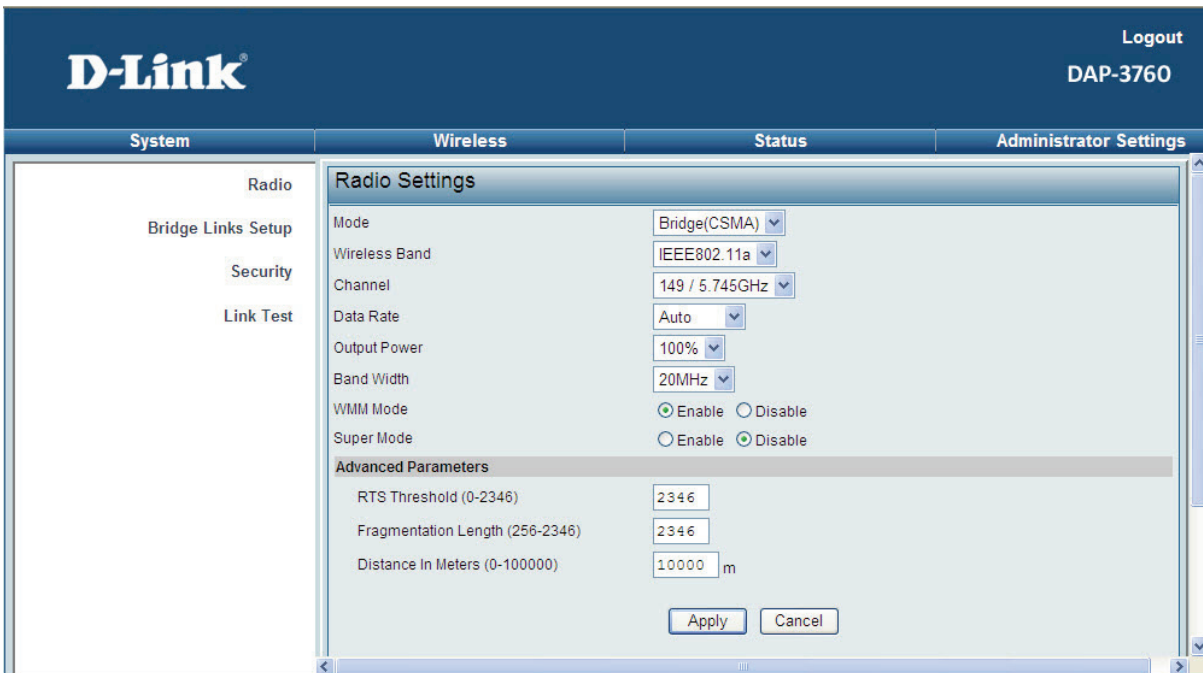

Figure 26 Bridge Links for TDMA

**Note:**

- When establish PTMP network, make sure all the remote wireless devices are within the antenna beam width.

## Antenna Alignment Tool

Under Bridge (CSMA) mode, Antenna Alignment Tool is available. This function helps to point in the approximate direction of the remote DAP-3760 antenna and assist user easily align the local antenna to reach maximum signal strength.

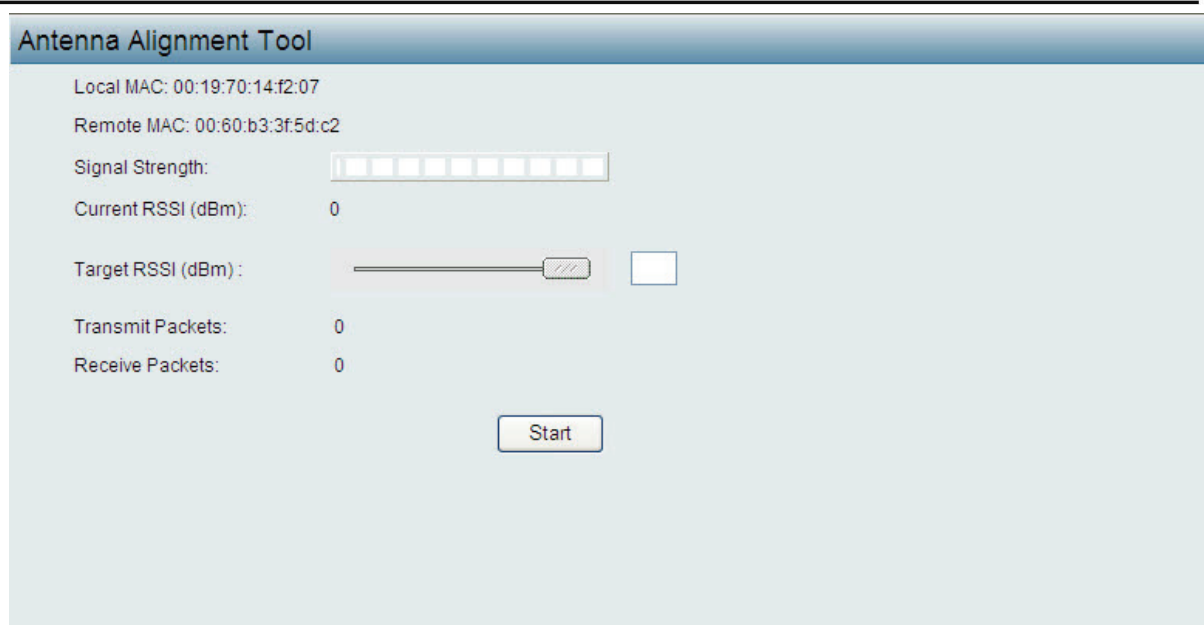

**Figure 27 Antenna Alignment Tool**

To use “**Antenna Alignment Tool**”, follow the steps bellow:

- Open “**Bridge Links Setup**”, by clicking “**Align Antenna**” button, “**Antenna Alignment Tool**” window will popup.
- Set the target RSSI (e.g. -70dBm) and click “**Start**” button.
- Wait about 5 seconds, the antenna alignment starts and performs alignment every one second.
- Fix the local antenna and adjust the remote antenna elevation and horizontal direction. During the adjustment, observe “**Current RSSI**” in local DAP-3760. The value will refresh every 1 second. Fix the remote antenna when it reaches your expectation. Usually, RSSI between -60 and -70dBm indicates rather good signal strength.
- Adjust the local antenna after fixing the remote one. During the adjustment, observe “**Current RSSI**” in the remote DAP-3760. Fix the local antenna when it reaches your expectation.
- During the antenna alignment, the DAP-3760 will issue beep sound to indicate current RSSI. Frequency of beep indicate the following RSSI:

**Table 3 RSSI-Beep Frequency**

RSSI	Beep Frequency
>-50	100 /sec
-50~-60	50 /sec
-60~-70	5 /sec
-70~-80	2 / sec
-80~-90	1 /sec
< -90	No beep sound

## Link Test

Under Bridge (TDMA) mode when Antenna Alignment Tool is not available, Link Test provides another option to check the signal strength towards the connecting device. Open **“Link Test”** in **“Wireless”** as below, and click **“Refresh”** to view the current signal strength of wireless connectivity. The table will be updated every 3 seconds. If the signal is not so good, align the antenna manually.

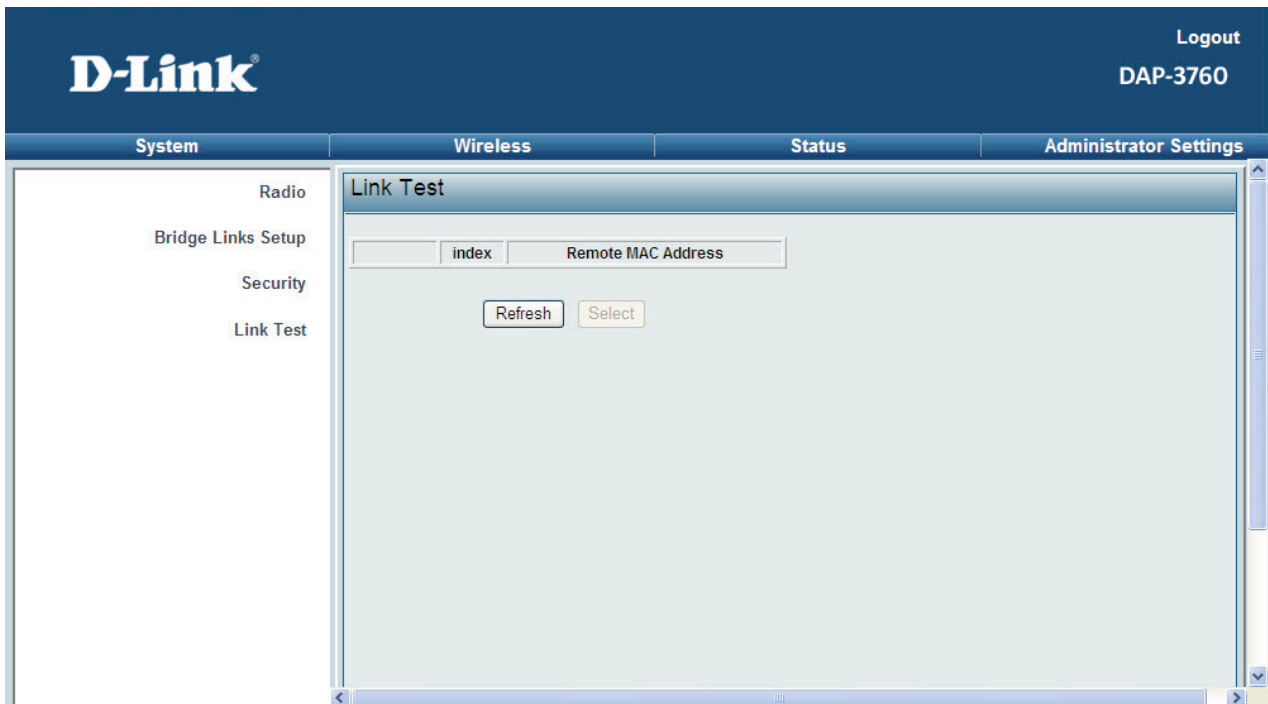

**Figure 28 Link Test**

## Wireless Security Settings

To prevent unauthorized radios from accessing data transmitting over the connectivity, DAP-3760 provides you with rock solid security settings.

### Security Profile Configuration

Open “**Security**” in “**Wireless**” as below:

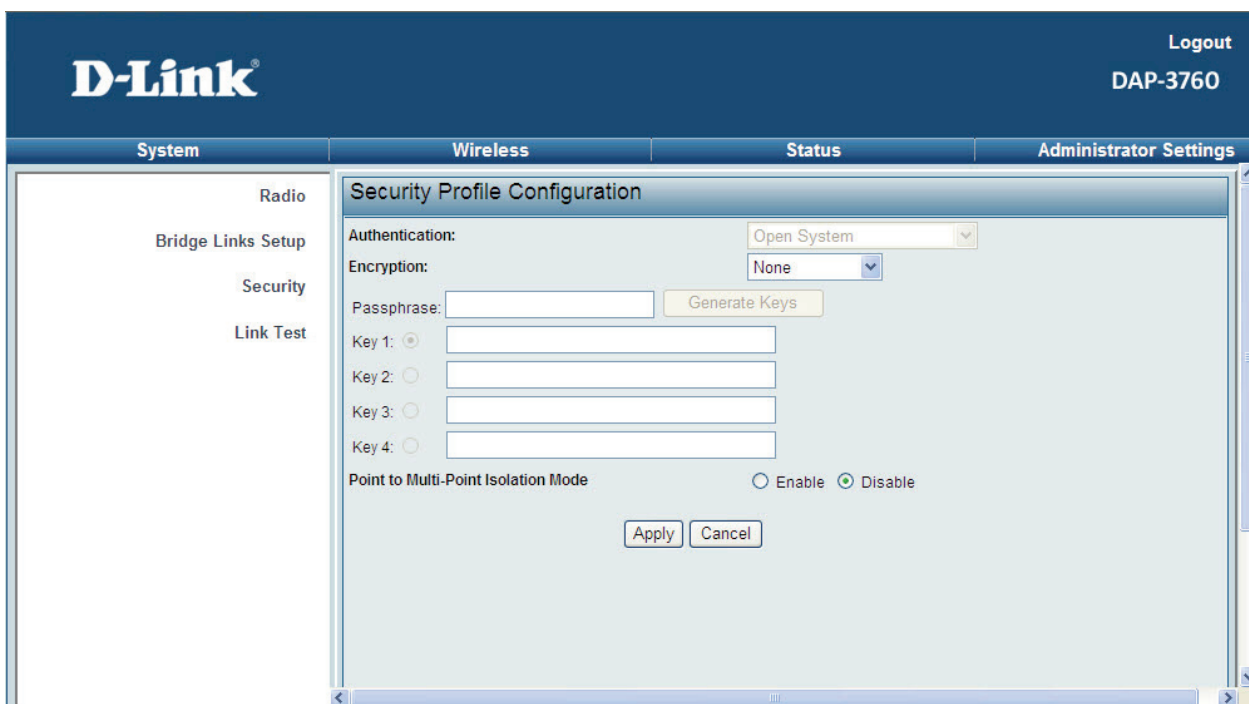

Figure 29 Security

- **Network Authentication**

**Open:** It allows any device to join the network without performing any security check.

- **Encryption**

If data encryption is enabled, the key is required and only sharing the same key with other wireless devices can the communication be established.

**None:** Available only when the authentication type is open system.

**64 bits WEP:** It is made up of 10 hexadecimal numbers.

**128 bits WEP:** It is made up of 26 hexadecimal numbers.

**152 bits WEP:** It is made up of 32 hexadecimal numbers.

**TKIP:** Temporal Key Integrity Protocol, which is a kind of dynamic encryption, is co-used with WPA-PSK, etc.

**AES:** Advanced Encryption Standard, it is usually co-used with WPA2-PSK, WPA, WPA2, etc.

 **Note:**

- 
- We strongly recommend you enable wireless security on your network!
  - Only setting the same Authentication, Data Encryption and Key in the DAP-3760 and other wireless devices that connecting with it, can the communication be established!
-

# Chapter 5 Management

## View DAP-3760 Basic Information

Open "System Information" in "System" to check the basic information of DAP-3760, which is read only.



Figure 30 System Information



## View Ethernet Traffic Statistics

Open “Ethernet Status” in “Status” to check the data packets received on and transmitted from the Ethernet port in LAN. Click “Refresh” to view current statistics. All is read only.

The screenshot shows the D-Link web interface for the DAP-3760 device. The top navigation bar includes the D-Link logo, a 'Logout' link, and the device model 'DAP-3760'. Below this is a menu with four tabs: 'System', 'Wireless', 'Status', and 'Administrator Settings'. The 'Status' tab is selected, and the 'Ethernet Status' option is highlighted in the left sidebar. The main content area displays 'Ethernet Traffic Statistics' with a table showing the following data:

	Received	Transmitted
Packets	1021	1394
Bytes	126304	759020

Below the table is a 'Refresh' button. The interface also features a left sidebar with 'Ethernet Status', 'Connections', and 'Wireless Status' options, and a bottom status bar.

Figure 31 Ethernet Traffic Statistics

## View Wireless Statistics

Open **“Wireless Status”** in **“Status”** to check the data packets received on and transmitted via wireless network. Click **“Refresh”** to view current statistics. All is read only.

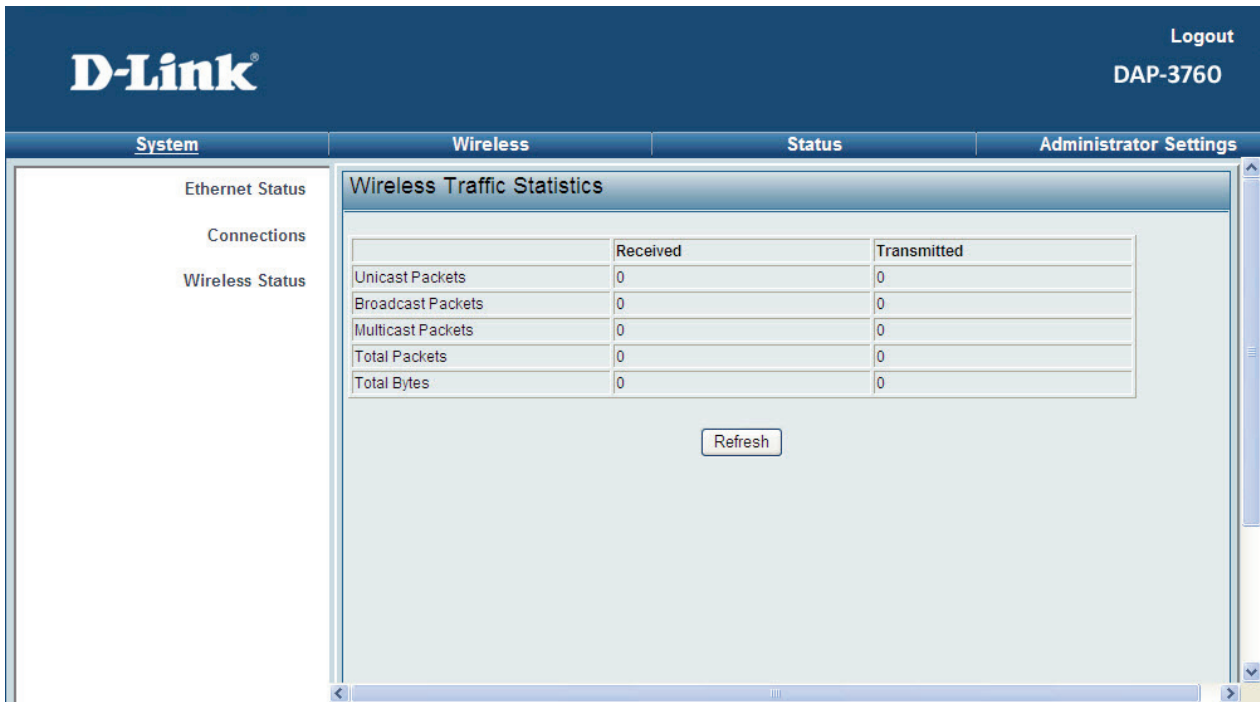

Figure 32 wireless Statistics

## Connections

Open “Connections” in “Status” to check the information of remote devices connected with bridge, these values also help determine whether the antenna is aligned in an appropriate direction. The table will be updated every 30 seconds. All is read only.

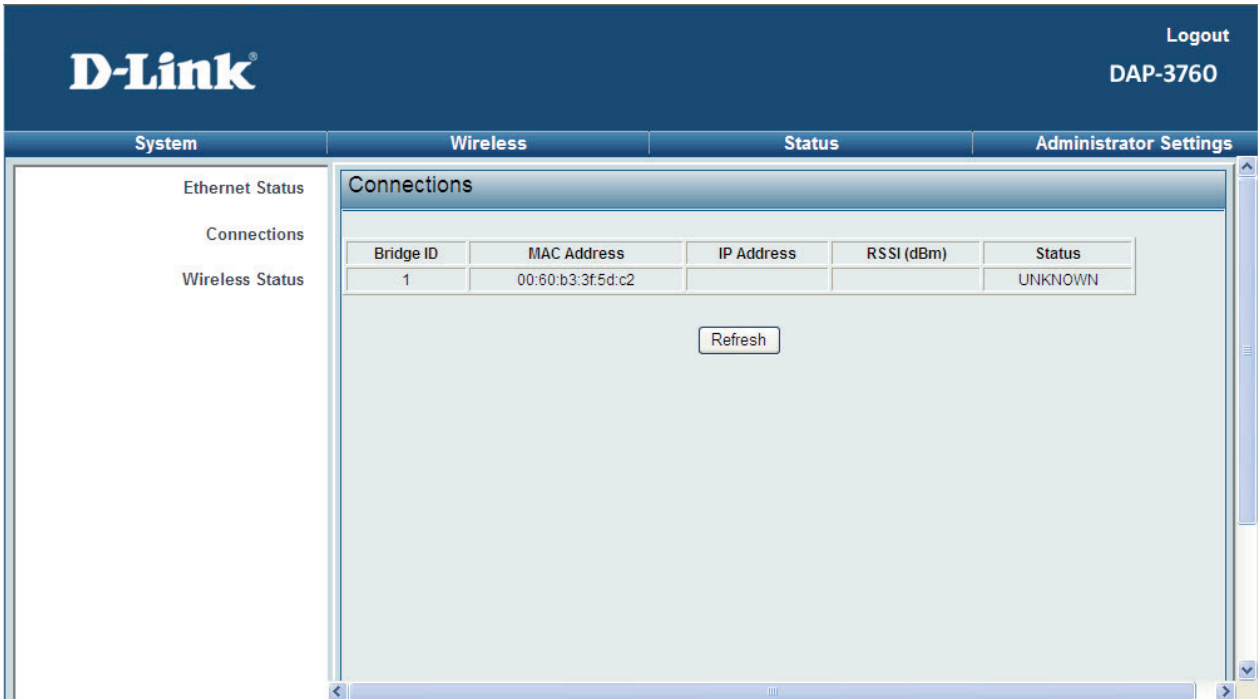

Figure 33 Connections

## Password

From “**Password**” in “**Administrator Settings**”, you can change or default the password to manage your DAP-3760.

The screenshot shows the D-Link DAP-3760 web interface. At the top, there is a dark blue header with the D-Link logo on the left and "Logout" and "DAP-3760" on the right. Below the header is a navigation bar with four tabs: "System", "Wireless", "Status", and "Administrator Settings". The "Administrator Settings" tab is selected. On the left side, there is a vertical menu with the following items: "Password", "Remote Management", "Firmware Upload", "Configuration File", "Log", and "Reboot". The "Password" item is selected. The main content area is titled "Password" and contains the following fields and options: "Current Password" (text input), "New Password" (text input), "Confirm New Password" (text input), and "Restore default password" (radio buttons for "Yes" and "No", with "No" selected). At the bottom of the form are "Apply" and "Cancel" buttons.

Figure 34 Password

- **Password**

For security concern, you have to enter the current password first and then enter the new one twice respectively in “**New Password**” and “**Confirm New Password**” fields.

- **Restore Default Password**

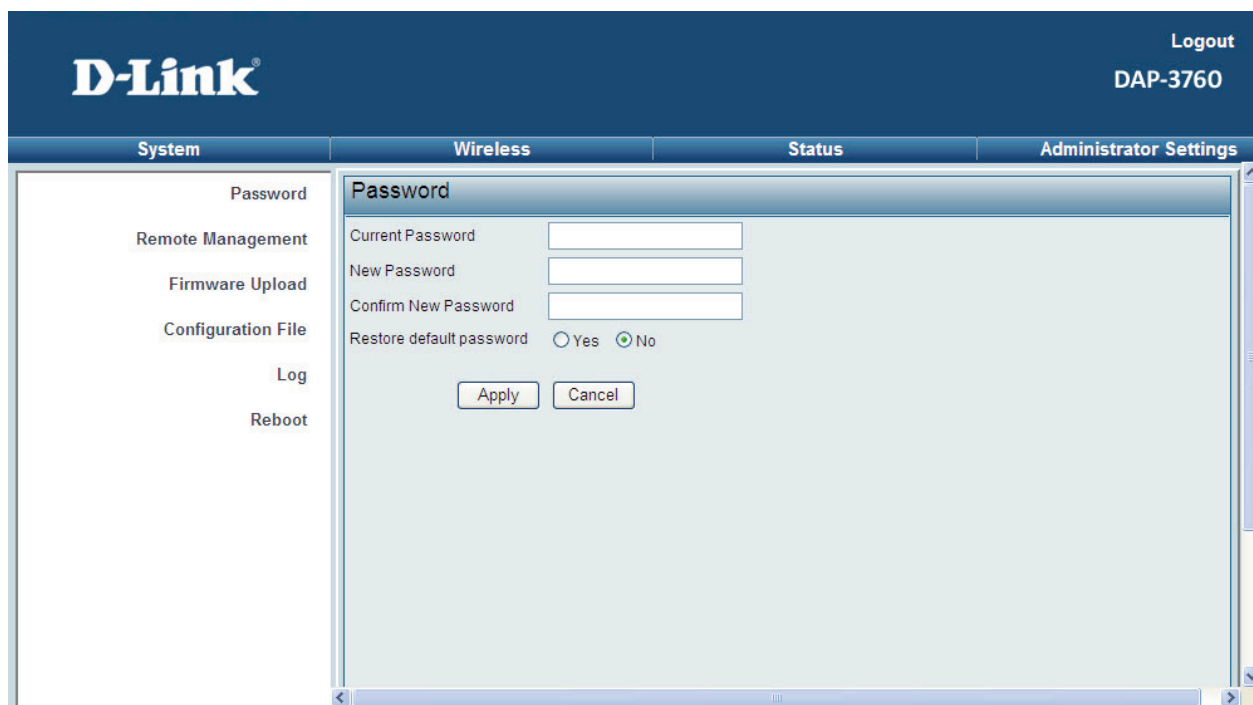
If you would like to restore the default password, enter the current password first and then check “**Yes**” and click “**Apply**” to default the password.

 **Note:**

- 
- The password is case-sensitive and its length can not exceed 19 characters!
- 

## Remote Management

The DAP-3760 provides you with two more options for device management, which are SSH (Secure Shell) and SNMP Settings.

Open **“Remote Management”** in **“Administrator Settings”** to configure the remote management of DAP-3760.

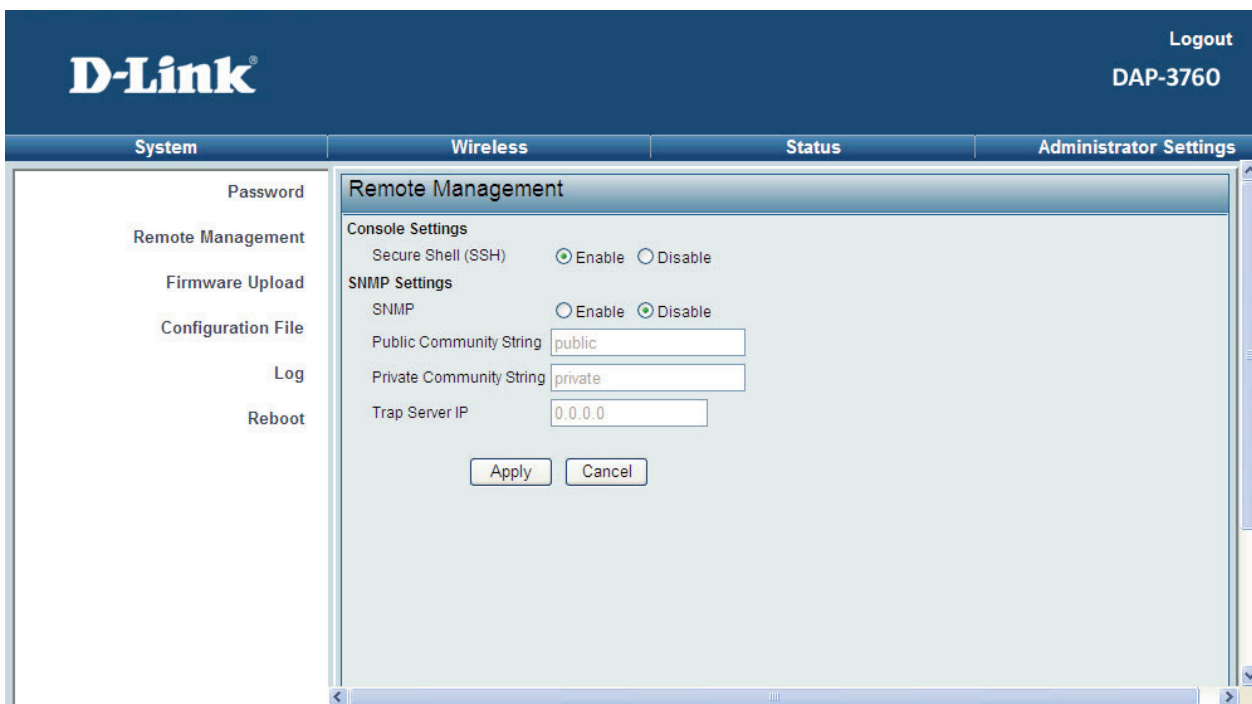

**Figure 35 Remote Management**

## Console Settings

The DAP-3760 supports CLI management, which could be accessed by Secure Shell (SSH). It is recommended PuTTY be used to login. Download it from <http://www.putty.org/> for free. The minimum system requirement for using PuTTY is Windows 95, 98, ME, NT, 2000, XP and Vista on Intel x86.

Follow the steps below to implement:



- Once the program is downloaded, open up by double-clicking `putty.exe`. Note that before using PuTTY, be sure you are able to connect to the DAP-3760.
- Enter IP Address of DAP-3760 (Default: 192.168.0.50), Port (22) and check SSH as connection type;

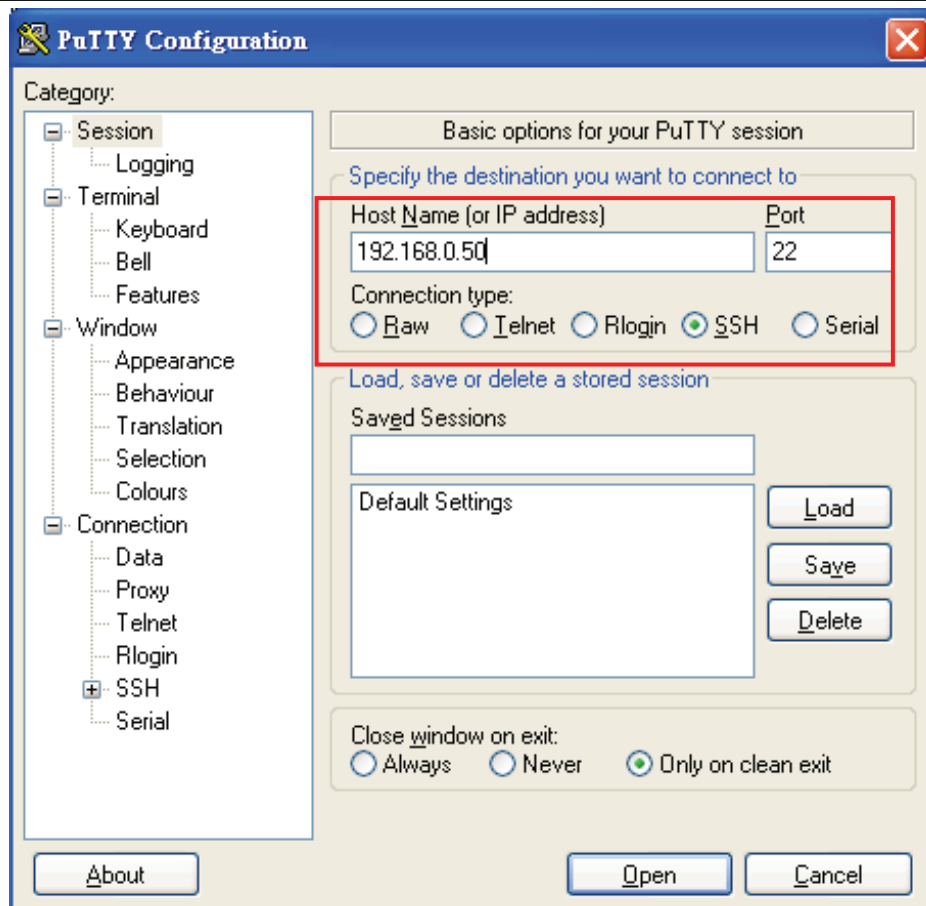

Figure 36 PuTTY Configuration 1

- From “**Connection**” in the left menu bar, click “**SSH**”; select “**2**” as “**Preferred SSH protocol version**”; make “**3DES**” the top position in “**Encryption cipher selection policy**”;

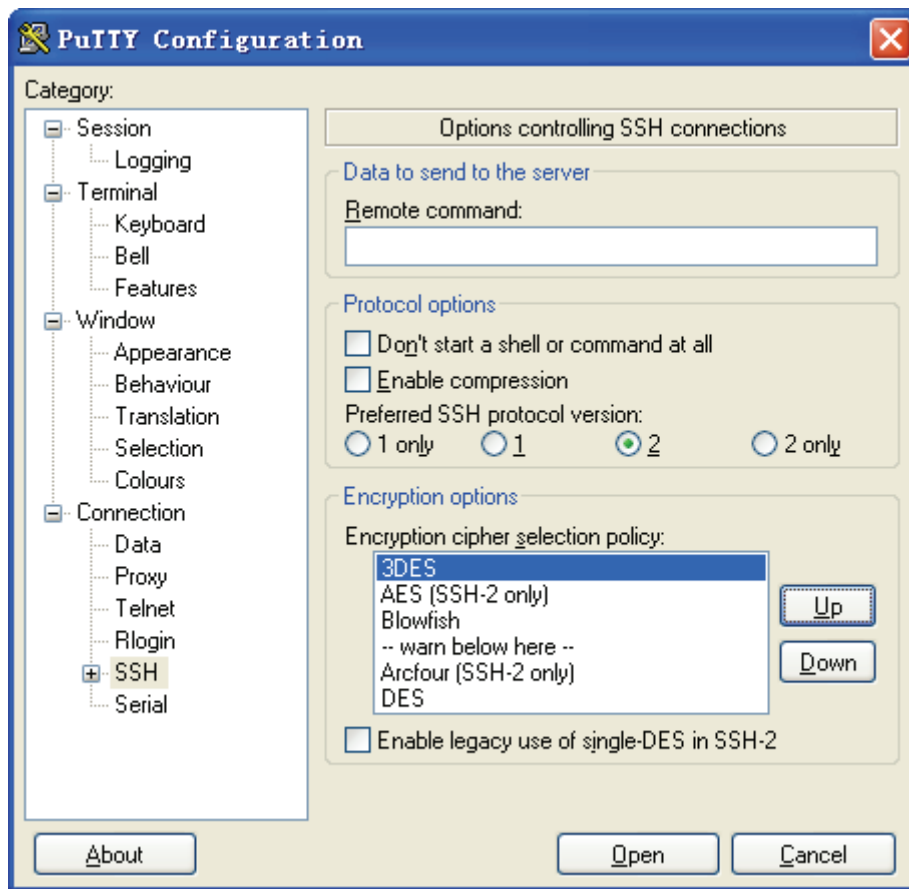

Figure 37 PuTTY Configuration 2

- Click “**Open**”, a window as below will popup:

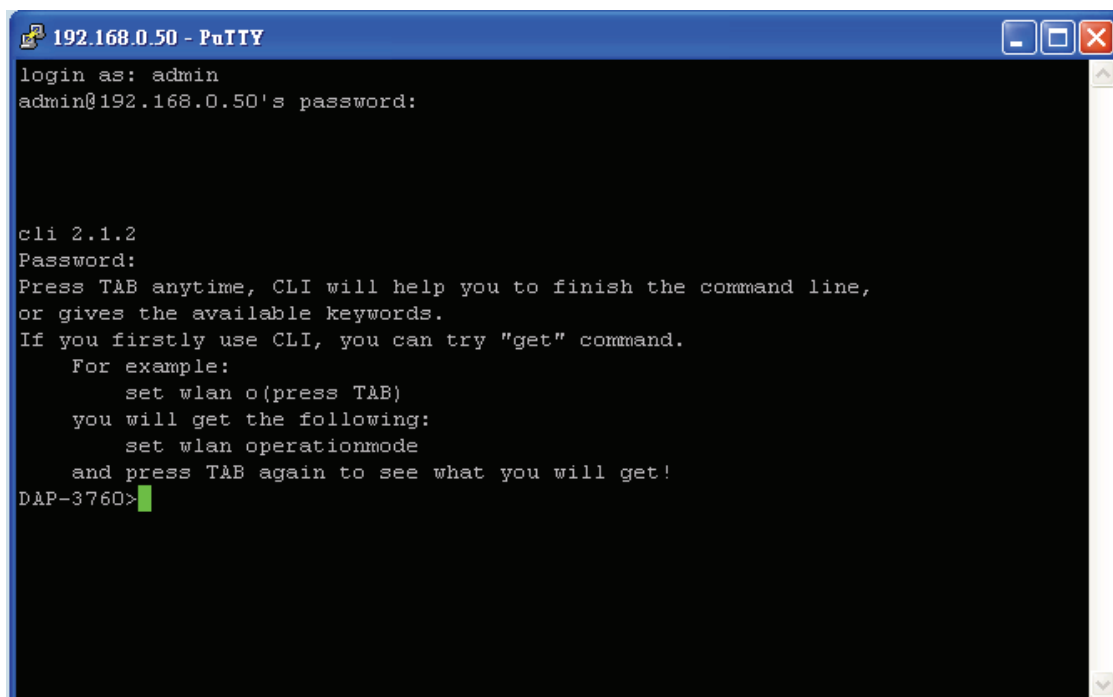

Figure 38 SSH

- Enter the user name and password (Default user name/ password: admin/password) respectively, you will see “DAP-3760>”, which is the name of DAP-3760;
- Enter “**help**” command to get setting information; alternatively, you can refer to [Appendix C. SSH Settings](#) for details.

## SNMP SETTINGS

The DAP-3760 supports SNMP management. Set the SNMP parameters and obtain MIB file before remote management.

- From “**Remote Management**” in “**Administrator Settings**”, set the parameters for SNMP Settings:
  - Enable SNMP by checking “**Enable**”;
  - Specify the “**Public Community String**”, “**Private Community String**” and “**Trap Server IP**”
  - Hit “**Apply**” to save settings.
- Obtain MIB file via FTP:
  - Enter ftp 192.168.0.50 , username (Default: **admin**) and password (Default: **Null**);
  - After successful login, enter command “**get Dlink.mib**”, the information will as below and then bridge.mib file is obtained.

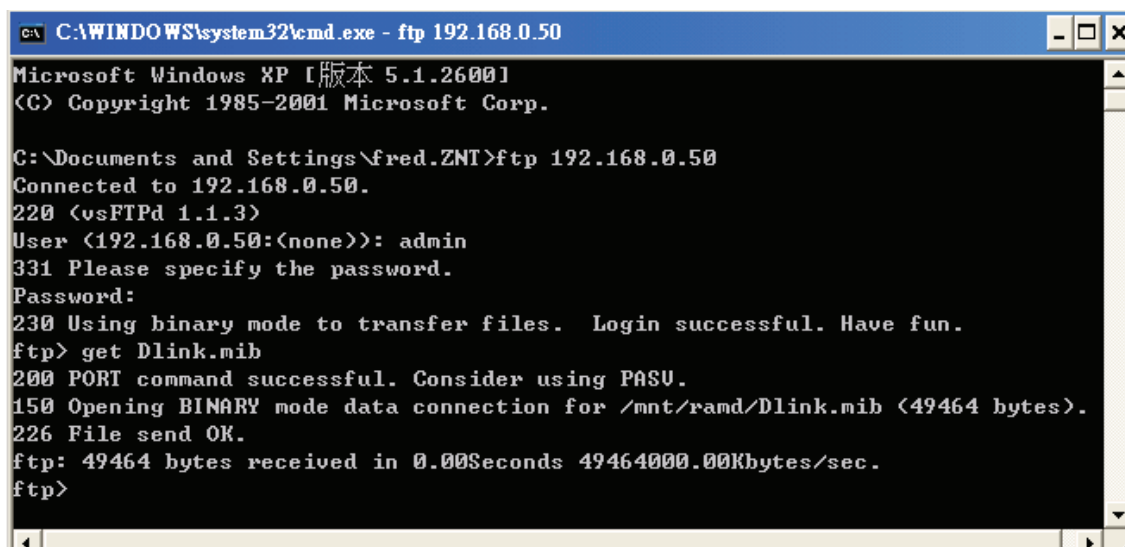

```
C:\WINDOWS\system32\cmd.exe - ftp 192.168.0.50
Microsoft Windows XP [版本 5.1.2600]
(C) Copyright 1985-2001 Microsoft Corp.

C:\Documents and Settings\fred.ZNT>ftp 192.168.0.50
Connected to 192.168.0.50.
220 (vsFTPd 1.1.3)
User (192.168.0.50:(none)): admin
331 Please specify the password.
Password:
230 Using binary mode to transfer files. Login successful. Have fun.
ftp> get Dlink.mib
200 PORT command successful. Consider using PASV.
150 Opening BINARY mode data connection for /mnt/ramd/Dlink.mib (49464 bytes).
226 File send OK.
ftp: 49464 bytes received in 0.00Seconds 49464000.00Kbytes/sec.
ftp>
```

Figure 39 Obtain MIB File



## SNTP Information/SNTP Setting

Compliant with NTP, DAP-3760 is capable of keeping its time in complete accord with the Internet time. Make configuration in “**Basic**” from “**System**”:

The screenshot shows the D-Link DAP-3760 web interface. The top navigation bar includes 'System', 'Wireless', 'Status', and 'Administrator Settings'. The 'System Information' section is expanded to show 'Basic' settings. The 'Wireless' tab is active, displaying network configuration fields. The 'SNTP Information/SNTP Setting' section is highlighted with a red border and contains the following fields:

SNTP/NTP Server IP	<input type="text"/>
SNTP/NTP Server Port	<input type="text" value="123"/>
SNTP/NTP Time Zone	<input type="text" value="(GMT-08:00) Pacific Time (US &amp; Canada); Tijuana"/>
<input type="checkbox"/> Daylight Saving Time	
Current Time	Mon Jun 30 16:01:22 2008

Below the SNTP settings is the 'GPS Coordinate Settings' section:

Latitude	<input type="text" value="N"/>	<input type="text" value="0"/>	<input type="text" value="0"/>	<input type="text" value="0"/>	<input type="text" value="''"/>
Longitude	<input type="text" value="E"/>	<input type="text" value="0"/>	<input type="text" value="0"/>	<input type="text" value="0"/>	<input type="text" value="''"/>

At the bottom of the configuration area are 'Apply' and 'Cancel' buttons.

**Figure 40 Time Settings**

- Enter the SNTP/NTP Server IP address and port respectively in “**SNTP/NTP Server IP**” and “**SNTP/NTP Server Port**” fields;
- Select your desired SNTP/NTP Time Zone from the drop-down list, check “**Daylight Saving Time**” if necessary;
- Hit “**Apply**” to save settings.

## GPS Coordinate Settings

It allows you to set your AP's location manually using latitude and longitude.

The screenshot shows the D-Link DAP-3760 web interface. The top navigation bar includes the D-Link logo, a 'Logout' button, and the device name 'DAP-3760'. Below the navigation bar are four tabs: 'System', 'Wireless', 'Status', and 'Administrator Settings'. The 'System' tab is active, and the 'Basic' sub-tab is selected. The main content area is divided into sections: 'Wireless' (IP Address: 192.168.0.50, IP Subnet Mask: 255.255.255.0, Default Gateway: 0.0.0.0, Primary DNS Server: 0.0.0.0, Secondary DNS Server: 0.0.0.0), 'SNTP Information/SNTP Setting' (SNTP/NTP Server IP, SNTP/NTP Server Port: 123, SNTP/NTP Time Zone: (GMT-08:00) Pacific Time (US & Canada); Tijuana, Daylight Saving Time checkbox), and 'GPS Coordinate Settings' (Latitude: N 0° 0' 0", Longitude: E 0° 0' 0"). The 'GPS Coordinate Settings' section is highlighted with a red border. At the bottom of the form are 'Apply' and 'Cancel' buttons.

- Enter the latitude and longitude of your AP in this field.

## Firmware Upload

Open “**Firmware Upload**” in “**Administrator Settings**” and follow the steps below to upgrade firmware locally or remotely through DAP-3760's Web:

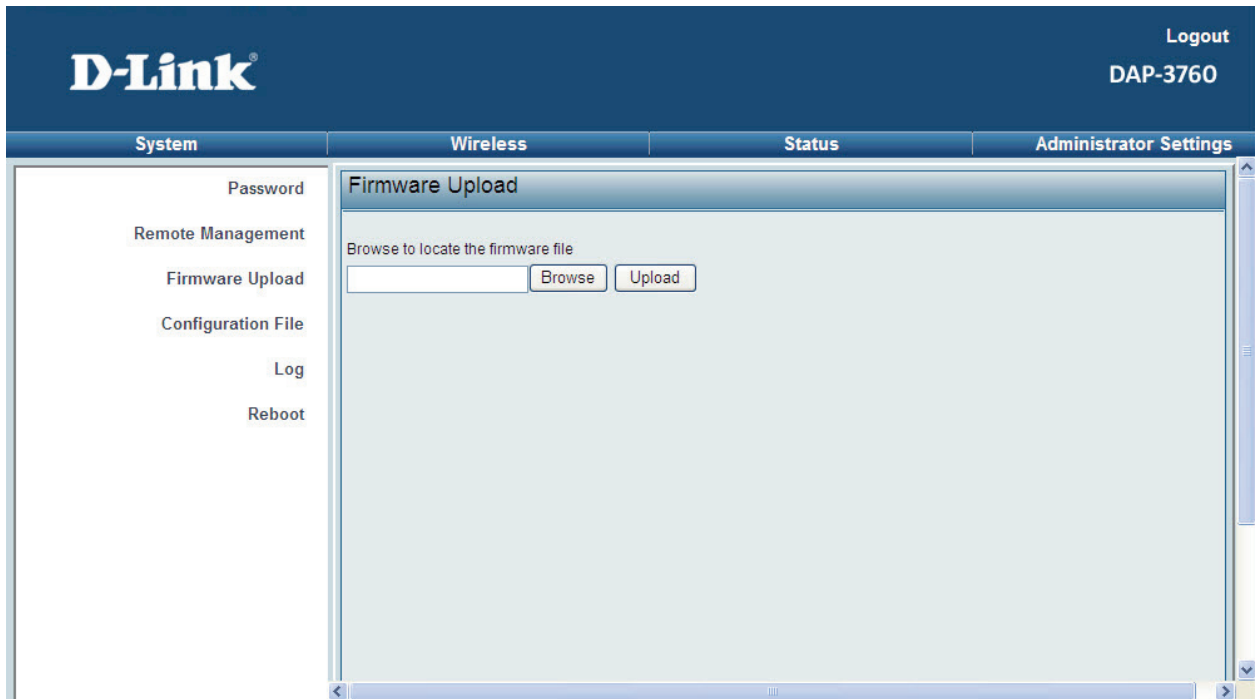

**Figure 41 Firmware Upload**

- Click “**Browse**” to select the firmware file;
- Click “**Upload**” to load the file into DAP-3760;
- Wait a moment, the system will reboot after successfully upgrade.

 **Note:**

- 
- Do NOT cut the power off during upgrade, otherwise the system may crash!
-

## Configuration File

It is strongly recommended to back up configuration information in case of something unexpected. If tragedy hits your device, you may have an access to restore the important files by the backup. All these can be done by the local or remote computer.

Open “**Configuration File**” in “**Administrator Settings**” as below:

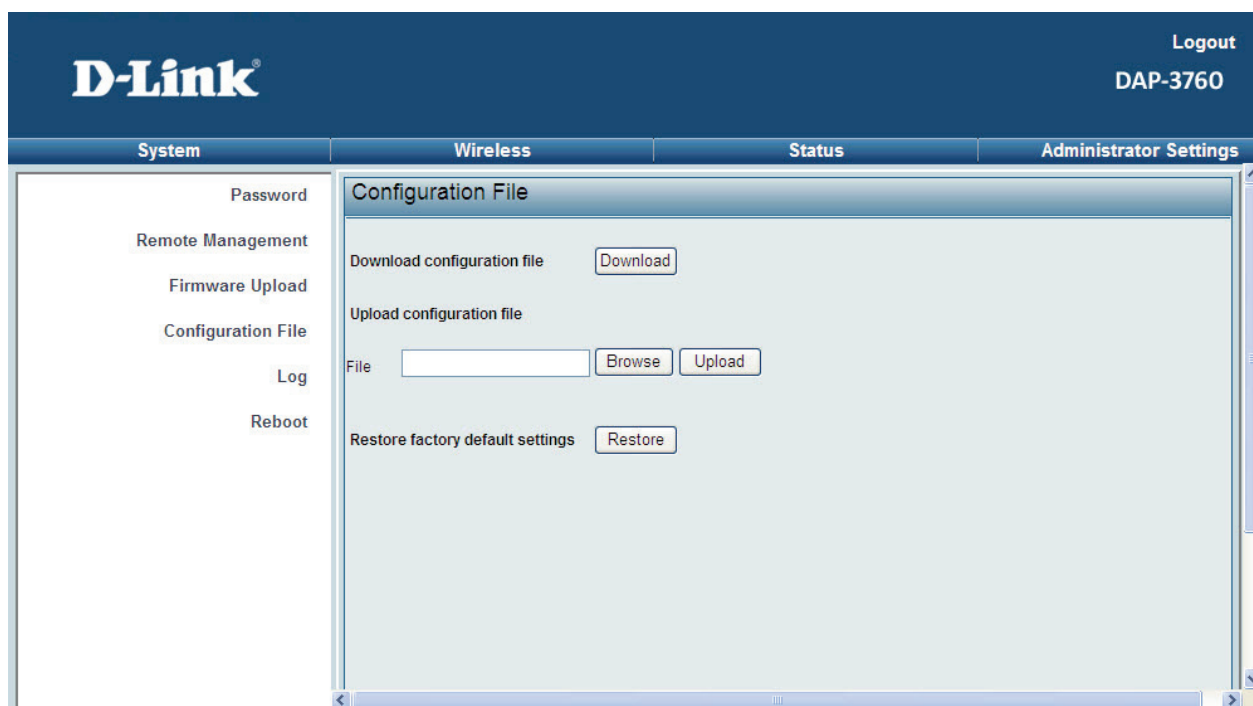

Figure 42 Configuration File

- **Download Configuration File**

By clicking “**Download**” a dialog box will popup. Save it, then the configuration file is saved to your local computer.

- **Upload Configuration File**

By clicking “**Browse**” a file selection menu will appear, select the file you want to load, like Dlink.cfg; Click “**Upload**” to load the file. After automatically rebooting, new settings are applied.

## Restore Factory Default Settings

The DAP-3760 provides two ways to restore the factory default settings:

- **Restore factory default settings via Web**

From “**Configuration File**”, clicking “**Restore**” will eliminate all current settings and reboot your device,

then default settings are applied.



**Figure 43 Restore Settings**

- **Restore factory default settings via RS-232**

If software in DAP-3760 is unexpectedly crashed and no longer reset the unit via Web, you may do hardware reset via RS-232. For detailed instructions please refer to [Chapter 2 RS-232 section](#).

## Log Settings

Log Settings is used for recording events occurred on the DAP-3760, including station connection, disconnection, system reboot and etc.

Open “Log” in “Administrator Settings” as below.

Time	Wlan	Event
Mon Nov 09 18:28:10 2009	WLAN0	00:19:70:14:F2:07 is ready in service.
Mon Nov 09 18:28:10 2009	WLAN0	Remote Bridge 00:60:B3:3F:5D:C2 joined.
Mon Nov 09 18:28:10 2009	WLAN0	00:19:70:14:F2:07 stop service.
Mon Nov 09 18:28:04 2009	WLAN0	00:19:70:14:F2:07 is ready in service.
Mon Nov 09 18:28:04 2009	WLAN0	Remote Bridge 00:60:B3:3F:5D:C2 joined.
Mon Nov 09 18:28:04 2009	WLAN0	00:19:70:14:F2:07 stop service.
Mon Nov 09 18:28:04 2009	WLAN0	00:19:70:14:F2:07 is ready in service.
Mon Nov 09 18:28:04 2009	WLAN0	Remote Bridge 00:60:B3:3F:5D:C2 joined.

Figure 44 Log Settings

- Enable Log: Enable System log or not;
- Log Server IP Address: Specify the IP address of the server;
- Log Server Port Number: Specify the port number of the server;
- Hit “**Apply**” to save settings;
- View Log: Lists all occurred events in this field.

# Reboot

You can reboot your device from “Reboot” in “Administrator Settings” as below:

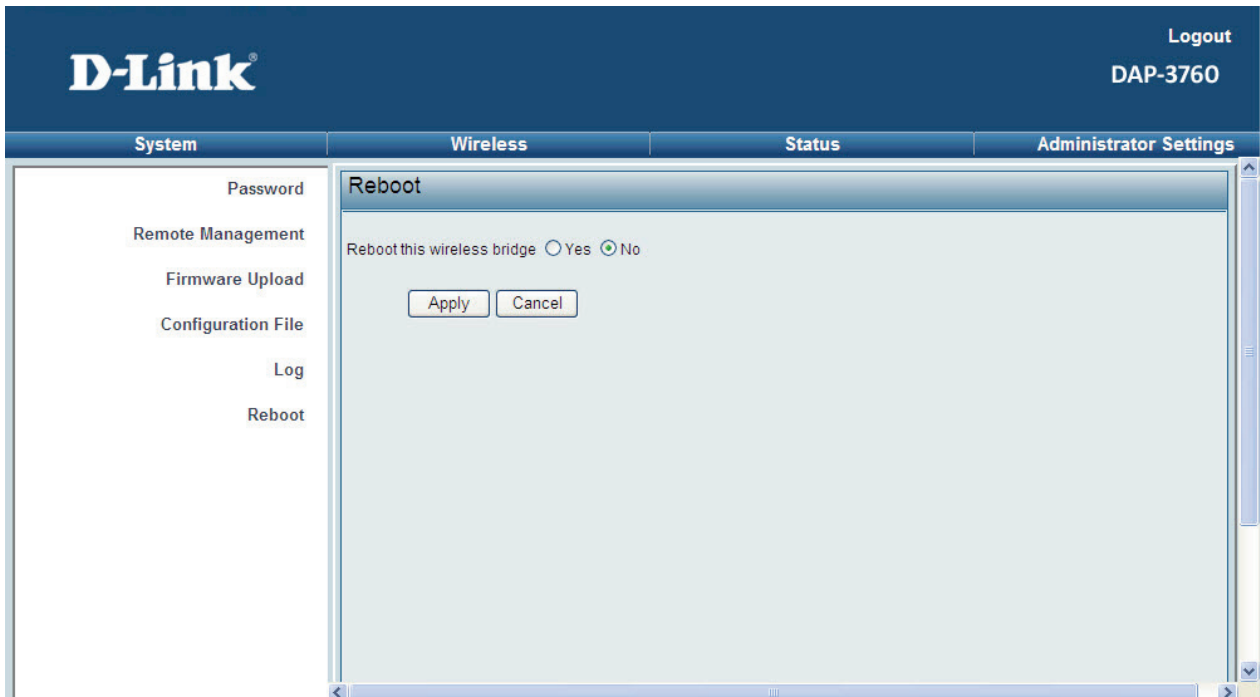

**Figure 45 Reboot**

- Check “Yes” and click “Apply” to reboot DAP-3760. This takes a few minutes, during which the device will send out the buzzing sound, informing you the system is rebooting.

## Chapter 6 Troubleshooting

This chapter provides troubleshooting procedures for basic problems with the DAP-3760. For warranty assistance, contact your service provider or distributor for the process.

### Q 1. What if my DAP-3760 fails to connect to the remote one?

- **Ethernet Link:** Check the availability of power to the bridge by observing the LED status on the power injector or on top of the RJ-45 Jack of the unit.
  - Green: The DAP-3760 is connecting to the backhaul network.
  - Off: The DAP-3760 disconnects from the wired network, check whether the power cord and Ethernet cables to the network and bridge are correctly connected.
- **Basic Configurations:** Mismatched basic settings among bridges are the most common cause of connectivity fail. If the bridge does not associate with a remote bridge, check whether options in each device are identical.
- **Security Settings:** Remote bridges attempting to authenticate to your bridge must support the same security options configured in your bridge, such as WEP and AES. If your bridge fails to associate with others, check whether the security settings are the same as your bridge settings.
- **Antenna Alignment:** If the methods above are all checked to be correct, you can observe and verify antenna alignment with RSSI value.

### Q 2. What if I would like to reset the unit to default settings?

You may restore factory default settings in “**Configuration File**” from “**Administrator Settings**”.

### Q 3. What if I would like to download and restore my configuration settings?

You may download by generating a configuration file or upload the settings you have backed up previously in “**Configuration File**” from “**Administrator Settings**”.

### Q 4. What if I can not open the Web-based management interface?

Please check the followings:

- Check whether the power supply is OK; Try to power on the unit again.
- Check whether the IP address of PC is correct (in the same network segment as the unit);
- Login the unit via other browsers such as Firefox.
- Hardware reset the unit.

### Q 5. What if the signal quality is poor or not so good?

- Check whether there is obstacle between units. Obstacle may lead to poor signal.
- Check the antenna height. Place the unit in a high position can help to get a better communication in long distance transmission.
- Check the polarization direction of antenna. Keep the polarization direction of antennas on two associating units the same; if not (one is horizontal, another is vertical), the signal quality may reduce dramatically.
- Check the antenna angle. Align the antenna to the remote one if using directional antenna. Big angle



shift may lead to poor signal.

- Check the feeder length. Too long feeder may increase the signal loss and affect the unit performance.

# Appendix GPL Declamation

## PUBLIC SOFTWARE DECLAMATION

**In the software we delivered, there are may contain some public software, if it is, please read below carefully:**

### 1. Definition

“**Public Software**”, when applicable, shall mean that portion of the Licensed Software, in source code form, set forth in the below Table, and provided under the terms set forth in the Section 5, the indicated website, the complete license terms can be found .

“Public Software” shall mean each of:

- (a) any computer code that contains, or is derived in any manner (in whole or in part) from, any computer code that is distributed as open source software (e.g. Linux) or similar licensing or distribution models; and
- (b) any software that requires as a condition of use, modification and/or distribution of such software that such software or other software incorporated into, derived from or distributed with such software (i) be disclosed or distributed in source code form, (ii) be licensed for the purpose of making derivative works, or (iii) be redistributable at no charge.

Public Software includes, without limitation, software licensed or distributed under any of the following licenses or distribution models, or licenses or distribution models similar to any of the following: (1) GNU's General Public License (GPL) or Lesser/Library GPL (LGPL); (2) the Artistic License (e.g., PERL); (3) the Mozilla Public License; (4) the Netscape Public License; (5) the Sun Community Source License (SCSL); (6) the Sun Industry Source License (SISL); and (7) the Apache Software license.

### 2. Limited Use

Any Public Software provided under the agreement shall be subject to the licenses, terms and conditions of its model. Licensee hereby agrees to comply with the terms and conditions applicable to any such Public Software, as set forth in its presentation on website.

### 3. Limited Liability

The supplier hereby express that the supplier shall have no liability for any costs, loss or damages resulting from Licensee's breach of the terms and conditions applicable to use, conversion or combination of the licensed software with or into Public Software.

### 4. NO WARRANTY.

This program or licensed software is distributed in the hope that it will be useful, but WITHOUT ANY WARRANTY. THE PROGRAM "AS IS" WITHOUT WARRANTY OF ANY KIND, EITHER EXPRESSED OR IMPLIED, INCLUDING, BUT NOT LIMITED TO, THE IMPLIED WARRANTIES OF MERCHANTABILITY AND FITNESS FOR A PARTICULAR PURPOSE. THE ENTIRE RISK AS TO THE QUALITY AND PERFORMANCE OF THE PROGRAM IS WITH LICENSEE.

### 5. Public Software Name and Description

#### Table 4 Public Software Name and Description

Program Name	Copy Right Description	Origin Sour Code	Licenses or Distribution Models or its special license terms	License Terms Website Reference
<b>Redboot</b>	Copyright (C) 1998, 1999, 2000, 2001, 2002, 2003 Red Hat, Inc.	ftp://ftp.ges.redhat.com/private/gnupro-xscale-030422/redboot-intel-xscale-030630.tar.Z	eCos License	<a href="http://sources.redhat.com/ecos/ecos-license/">http://sources.redhat.com/ecos/ecos-license/</a>
<b>Busybox</b>		<a href="http://www.busybox.net/downloads/busybox-1.01.tar.bz2">http://www.busybox.net/downloads/busybox-1.01.tar.bz2</a>	GNU GENERAL PUBLIC LICENSE Version 2	<a href="http://www.gnu.org/licenses/old-licenses/gpl-2.0.html">http://www.gnu.org/licenses/old-licenses/gpl-2.0.html</a>
<b>brctl</b>	Copyright (C) 2000 Lennert Buytenhek	<a href="http://nchc.dl.sourceforge.net/sourceforge/bridge/bridge-utils-1.0.6.tar.gz">http://nchc.dl.sourceforge.net/sourceforge/bridge/bridge-utils-1.0.6.tar.gz</a>	GNU GENERAL PUBLIC LICENSE Version 2	<a href="http://www.gnu.org/licenses/old-licenses/gpl-2.0.html">http://www.gnu.org/licenses/old-licenses/gpl-2.0.html</a>
<b>dropbear</b>	Copyright (c) 2002-2006 Matt Johnston Portions copyright (c) 2004 Mihnea Stoenescu	<a href="http://mattucc.asn.au/dropbear/dropbear-0.51.tar.bz2">http://mattucc.asn.au/dropbear/dropbear-0.51.tar.bz2</a>	GNU GENERAL PUBLIC LICENSE Version 2	<a href="http://www.gnu.org/licenses/old-licenses/gpl-2.0.html">http://www.gnu.org/licenses/old-licenses/gpl-2.0.html</a>
<b>hostapd</b>	Copyright (c) 2002-2006, Jouni Malinen <jkmaline@cc.hut.fi> and contributors	<a href="http://hostap.epitest.fi/releases/hostapd-0.4.8.tar.gz">http://hostap.epitest.fi/releases/hostapd-0.4.8.tar.gz</a>	GNU GENERAL PUBLIC LICENSE Version 2	<a href="http://www.gnu.org/licenses/old-licenses/gpl-2.0.html">http://www.gnu.org/licenses/old-licenses/gpl-2.0.html</a>
<b>wpa_supplicant</b>	Copyright (c) 2003-2005, Jouni Malinen <jkmaline@cc.hut.fi> and contributors	<a href="http://hostap.epitest.fi/releases/wpa_supplicant-0.4.7.tar.gz">http://hostap.epitest.fi/releases/wpa_supplicant-0.4.7.tar.gz</a>	GNU GENERAL PUBLIC LICENSE Version 2	<a href="http://www.gnu.org/licenses/old-licenses/gpl-2.0.html">http://www.gnu.org/licenses/old-licenses/gpl-2.0.html</a>
<b>mtduutil</b>		<a href="ftp://ftp.uk.linux.org/pub/people/dwmw2/mtd/cvs/mtd/util/">ftp://ftp.uk.linux.org/pub/people/dwmw2/mtd/cvs/mtd/util/</a>	GNU GENERAL PUBLIC LICENSE Version 2	<a href="http://www.gnu.org/licenses/old-licenses/gpl-2.0.html">http://www.gnu.org/licenses/old-licenses/gpl-2.0.html</a>
<b>ntpclient</b>	Copyright 1997, 1999, 2000, 2003 Larry Doolittle	<a href="http://doolittle.icarus.com/ntpclient/ntpclient_2003_194.tar.gz">http://doolittle.icarus.com/ntpclient/ntpclient_2003_194.tar.gz</a>	GNU GENERAL PUBLIC LICENSE Version 2	<a href="http://www.gnu.org/licenses/old-licenses/gpl-2.0.html">http://www.gnu.org/licenses/old-licenses/gpl-2.0.html</a>
<b>procps</b>	Author: Albert Cahalan, Michael K. Johnson, Jim Warner, etc.	<a href="http://procps.sourceforge.net/procps-3.2.7.tar.gz">http://procps.sourceforge.net/procps-3.2.7.tar.gz</a>	GNU GENERAL PUBLIC LICENSE Version 2 GNU LIBRARY GENERAL PUBLIC LICENSE Version 2	<a href="http://www.gnu.org/licenses/old-licenses/gpl-2.0.html">http://www.gnu.org/licenses/old-licenses/gpl-2.0.html</a> <a href="http://www.gnu.org/licenses/old-licenses/lgpl-2.0.html">http://www.gnu.org/licenses/old-licenses/lgpl-2.0.html</a>

				<a href="http://www.gnu.org/licenses/old-licenses/library.html">rg/licenses/old-licenses/library.html</a>
<b>vsftpd</b>	Author: Chris Evans	<a href="ftp://vsftpd.beasts.org/users/cevang/vsftpd-1.1.2.tar.gz">ftp://vsftpd.beasts.org/users/cevang/vsftpd-1.1.2.tar.gz</a>	GNU GENERAL PUBLIC LICENSE Version 2	<a href="http://www.gnu.org/licenses/old-licenses/gpl-2.0.html">http://www.gnu.org/licenses/old-licenses/gpl-2.0.html</a>
<b>linux</b>		<a href="ftp://ftp.kernel.org/pub/linux/kernel/v2.6/linux-2.6.20.3.tar.bz2">ftp://ftp.kernel.org/pub/linux/kernel/v2.6/linux-2.6.20.3.tar.bz2</a>	GNU GENERAL PUBLIC LICENSE Version 2	<a href="http://www.gnu.org/licenses/old-licenses/gpl-2.0.html">http://www.gnu.org/licenses/old-licenses/gpl-2.0.html</a>