



# User Manual

## Pan & Tilt Wi-Fi Day/Night Camera

DCS-5000L

---

# Manual Overview

D-Link reserves the right to revise this publication and to make changes in the content hereof without obligation to notify any person or organization of such revisions or changes. Information in this document may become obsolete as our services and websites develop and change. Please refer to the [www.mydlink.com](http://www.mydlink.com) website for the most current information.

## Manual Revision

Revision	Date	Description
1.00	13 November, 2015	Initial A1 release

## Trademarks

D-Link and the D-Link logo are trademarks or registered trademarks of D-Link Corporation or its subsidiaries in the United States or other countries. All other company or product names mentioned herein are trademarks or registered trademarks of their respective companies.

Apple®, Apple logo®, Safari®, iPhone®, iPad®, iPod touch® and Macintosh® are trademarks of Apple Inc., registered in the U.S. and other countries. App StoreSM is a service mark of Apple Inc. Chrome™ browser, Google Play™ and Android™ are trademarks of Google Inc. Internet Explorer®, Windows® and the Windows logo are trademarks of the Microsoft group of companies.

Copyright © 2015 by D-Link Corporation, Inc. All rights reserved. This publication may not be reproduced, in whole or in part, without prior expressed written permission from D-Link Corporation, Inc.

### ErP Power Usage

This device is an Energy Related Product (ErP) designed to be always on. If it is not needed during certain periods of time, it can be unplugged to save energy.

---

# Table of Contents

<b>Product Overview.....</b>	<b>5</b>	Wizard.....	29
Package Contents.....	5	Internet Connection Setup Wizard.....	30
System Requirements.....	6	Network Setup.....	32
Introduction.....	7	Wireless Setup.....	34
Features.....	8	Dynamic DNS (DDNS).....	35
Hardware Overview.....	10	Image Setup.....	36
Front View.....	10	Video.....	37
Rear View.....	11	Audio.....	38
<b>Installation.....</b>	<b>12</b>	Motion Detection.....	39
Mobile App Setup.....	13	Sound Detection.....	40
mydlink Lite.....	14	Mail.....	41
Zero Configuration Setup.....	15	FTP.....	44
Camera Setup Wizard.....	18	Time and Date.....	46
Windows Users.....	18	Day/Night Mode.....	47
Mac Users.....	19	Camera Control.....	48
Manual Hardware Installation.....	20	Maintenance.....	50
Wireless Installation Considerations.....	21	Admin.....	50
WPS - Push Button Setup.....	22	System.....	52
Mounting Instructions.....	23	Firmware Upgrade.....	53
mydlink.....	25	Status.....	54
<b>Configuration.....</b>	<b>26</b>	Device Info.....	54
Using the Web Configuration Interface.....	26	Active User.....	55
Live Video.....	27	Help.....	56
Setup.....	29	<b>Troubleshooting.....</b>	<b>57</b>

**Technical Specifications ..... 60**

**Regulatory Statements ..... 62**

# Package Contents



DCS-5000L Pan & Tilt Wi-Fi Day/Night Camera



Camera Base and Mounting Kit

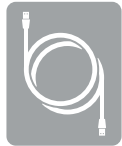

CAT5 Ethernet Cable



Micro-USB Power Adapter



Quick Install Guide



Quick Install Card

If any of the above items are missing, please contact your reseller.

**Note:** Using a power supply with a different voltage than the one included with your product will cause damage and void the warranty for this product.

# System Requirements

<p><b>Network Requirements</b></p>	<ul style="list-style-type: none"> <li>• 10/100 Ethernet network or a 802.11n/g wireless network</li> <li>• An Internet connection</li> <li>• A router connected to your broadband modem</li> </ul>
<p><b>Setup Wizard Requirements</b></p>	<p><b>Computer with the following:</b></p> <ul style="list-style-type: none"> <li>• A PC with a wired connection to your router</li> <li>• Windows® 10, 8 (32/64-bit), 7 (32/64-bit), Vista® (32/64-bit), Mac OS®X 10.7 or above</li> </ul>
<p><b>Web-based Configuration Utility Requirements</b></p>	<p><b>Browser Requirements:</b></p> <ul style="list-style-type: none"> <li>• Internet Explorer 8 or higher</li> <li>• Firefox 12 or higher</li> <li>• Safari 6 or higher</li> </ul> <p><b>Note:</b> Make sure you have the latest version of Java installed. Visit <a href="http://www.java.com">www.java.com</a> to download the latest version.</p>
<p><b>mydlink Website Requirements</b></p>	<ul style="list-style-type: none"> <li>• Broadband Internet connection</li> </ul> <p>Computer with:</p> <ul style="list-style-type: none"> <li>• Internet Explorer 8 or higher (ActiveX)</li> <li>• Firefox 12 or higher</li> <li>• Safari 6 or higher</li> <li>• Chrome 20 or higher</li> </ul>

# Introduction

Congratulations on your purchase of the DCS-5000L Pan & Tilt Wi-Fi Day/Night Camera. The DCS-5000L is a versatile and unique solution for your home or small office. Unlike a standard webcam, the DCS-5000L is a complete system with a built-in CPU, web server, and wireless networking device that transmits high quality video images for security and surveillance. The pan/tilt function allows the camera to patrol a wide area, while the built-in IR LEDs provide around-the-clock surveillance regardless of the lighting conditions.

The DCS-5000L can be accessed remotely, and controlled from any PC/laptop over your local network or through the Internet via a web browser. The simple installation and intuitive web-based interface offer easy integration with your Ethernet/Fast Ethernet or 802.11 b/g/n wireless network. Wireless N technology gives you the freedom to place the DCS-5000L anywhere within range of your existing wireless network. The DCS-5000L also comes with remote monitoring and motion detection features for a customized, cost-effective security solution.

Your DCS-5000L is mydlink-enabled, which means that you can view and manage your camera over the Internet through the mydlink website, or through the mydlink mobile app for iOS and Android. You can view your live video feed, take snapshots, and manage the camera's configuration, all from anywhere you have Internet access.

# Features

## **Easy to Use and mydlink-Enabled for Easy Access and Management**

The DCS-5000L is a standalone surveillance camera that requires no special hardware or software, and can operate independently, even without a PC. This camera is also mydlink-enabled, which means you can view and manage your camera through the mydlink website, or through the mydlink mobile app for iOS and Android mobile devices.

## **Pan/Tilt for Wide Viewing Area**

Patrol a large area with one camera thanks to the DCS-5000L's pan and tilt functions. You can use the web interface to manually adjust the camera lens position, or set up to 24 pre-defined preset positions, enabling you to quickly move to frequently used points of interest.

## **IR LEDs for Day and Night functionality**

The built-in infrared LEDs enable night time viewing of up to 8 meters (26 feet), giving you clear images regardless of lighting conditions.

## **MJPEG Codec for Smooth, Space-Efficient Video**

This camera supports use of the MJPEG video codec, which gives you high-quality video with reduced bandwidth requirements. This means that you can enjoy smoother, more reliable video streaming over the Internet, and less disk space is required to save recordings.

## **Motion Triggered Notifications and Recordings**

The DCS-5000L can send email notifications with snapshots whenever motion is detected. You can customize areas of the video to monitor for motion to keep watch over specific areas of interest, and have the DCS-5000L send you an email notification or upload images to an FTP server whenever motion is detected.



### **802.11n/g/b Wireless or Ethernet/Fast Ethernet Support**

The DCS-5000L offers wireless 802.11n/g/b and Ethernet/Fast Ethernet connectivity, making it easy to integrate into your existing network environment. The DCS-5000L works with either a 10 Mbps Ethernet-based network or 100 Mbps Fast Ethernet-based network for traditional wired environments, and works with 802.11n/g/b wireless routers or access points for added flexibility. The Site Survey feature also allows you to view and connect to any available wireless networks within range of the camera.

### **Micro-USB Powered for Convenience**

For added convenience, the DCS-5000L can be powered via any Micro-USB cable, so you don't have to worry about looking for a matching power adapter when setting it up for use. Simply use the included or standard Micro-USB cable and plug it into any USB power adapter or powered USB port and it'll be powered on and ready for use.

### **Remote Monitoring with mydlink Lite App**

With the mydlink Lite app for mobile devices, you can easily view live streams and manage your camera from anywhere with an Internet connection.

# Hardware Overview

## Front View



1	<b>Light Sensor</b>	The IR-Cut Removable sensor monitors lighting conditions and switches between color and infrared accordingly.
2	<b>Camera Lens</b>	Records video of the surrounding area.
3	<b>Manual Focus Bezel</b>	Manually adjust the focus of the lens for your required view.
4	<b>WPS LED</b>	Indicates the WPS connection status of the camera.
5	<b>Microphone</b>	Records audio from the surrounding area.
6	<b>Infrared LEDs</b>	Illuminate the camera's field of view in low light environments.
7	<b>Power and Link LED</b>	Indicates the camera's current status.

## Rear View



1	<b>WPS Button</b>	Press this button, then press the WPS button for 5 seconds on your router to set up a wireless connection automatically.
2	<b>Reset Button</b>	Press and hold this button for 10 seconds to reset the camera.
3	<b>Ethernet Port</b>	RJ45 connector for Ethernet.
4	<b>Micro-USB Port</b>	Connect a Micro-USB cable here to power on the camera.

# Installation

There are three ways to set up your camera:

- **Mobile App Setup:** You can set up your DCS-5000L with the free mydlink Lite app. Refer to **Mobile App Setup** on page 13.
- **Zero Configuration Setup:** If you have a mydlink-enabled router (D-Link cloud router), this is the easiest way to set up your camera. Refer to **Zero Configuration Setup** on page 15.
- **Camera Installation Wizard:** If you do not have a mydlink-enabled router, use the Camera Installation Wizard to guide you through setup and initial configuration of your camera. Refer to **Camera Setup Wizard** on page 18.
- **Manual Hardware Installation:** This section shows you how to manually set up your camera, however, in order to use the mydlink features of your camera, you will still need to run the Camera Installation Wizard. Refer to **Manual Hardware Installation** on page 20.

# Mobile App Setup

**The mydlink Lite app allows you to configure your camera without a PC**, and lets your camera work together with other mydlink Lite compatible devices. Search for the free **mydlink Lite** app on the App Store or Google Play and download it to your smartphone or tablet. You can also use a QR code reading app to scan the corresponding code for your device below.



# mydlink Lite

You can monitor your camera using the mydlink Lite app either from your local network (same as the camera's) or remotely from anywhere with an Internet connection. To use either method, follow the steps below:

## To view your camera feed on a local network:

1. Using your mobile, connect to the same wireless network as your camera.
2. Download the mydlink Lite app using a QR code in the previous page.
3. On the login page, tap **Local**. The app will automatically discover any D-Link cameras in your network.
4. Tap the DCS-5000L icon to begin setup.
5. Enter your camera's administrator password (it will be on your Quick Install Card if you haven't configured it). Tick the Remember Me box and tap **OK**. You will be taken to the Live View page of your camera.

## To view your camera feed remotely:

1. To enable remote monitoring, you will need to use mydlink services. Start the mydlink Lite app on your mobile device.
2. If you already have an account, you can tap **Sign In**. If you don't have a mydlink account and want to register for one, you can tap the **New users, sign up here**. link to start the registration process.



mydlink Lite



# Zero Configuration Setup

**If you have a mydlink-enabled Cloud Router**, you can take advantage of Zero Configuration Setup. Zero Configuration automatically configures your camera's settings such as Wi-Fi name/password for you, and adds the camera to your mydlink account automatically. This type of setup allows you to set up your camera by simply plugging it in and connecting it to your router.

Connect your camera to your mydlink-enabled Cloud Router and Zero Configuration will automatically configure your DCS-5000L and add the camera to your mydlink account. After a short period of time, you will be able to remotely access your camera from the website <http://www.mydlink.com> to manage and monitor your DCS-5000L.

## Connect the Ethernet Cable and the Micro-USB Plug

Use the included Ethernet cable and plug it into the camera. Plug the other end into an available port on your D-link Cloud Router. If you wish to use your camera wirelessly, you will be able to remove the cable after Zero Configuration Setup is complete. Plug one end of the included Micro-USB power adapter to the back of the camera.

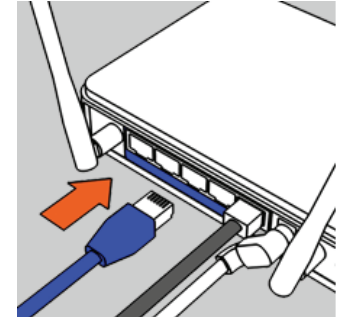
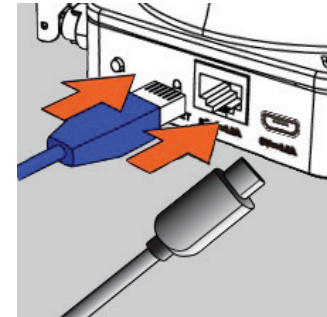

## Plug the Micro-USB Power Adapter to a Wall Outlet

Plug the other end of the Micro-USB power adapter to a wall outlet to power on your camera.

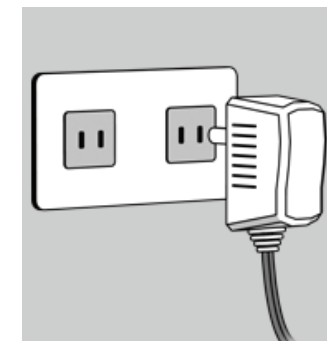

## Check Your mydlink Account

From any computer with an Internet connection, open a web browser and log in to your mydlink account. The mydlink page will check for new devices and display a **New device Found!** pop-up notification in the bottom-left corner. Click the notification to continue.

The screenshot shows the mydlink web interface. At the top, there's a navigation bar with 'My Devices', 'Shared Devices', 'My Services', and 'My Profile'. The main content area displays 'Router Status' for a DIR-605L router. It shows various settings like Model Name, Network Name (SSID), Internet IP, LAN IP, and Connected Devices. Below this is a 'Connection List' table with columns for Device, Device Name, IP Address, MAC Address, and Block. A 'New Devices!' notification is visible in the bottom-left corner, highlighted with a red box, showing 'DCS-5000L'.

Device	Device Name	IP Address	MAC Address	Block
	CardboardBox	192.168.0.110	00:28:2D:02:FE:FA	<input type="checkbox"/>
	--	192.168.0.120	04:54:53:50:53:18	<input type="checkbox"/>
	HelGuy	192.168.0.100	00:1A:92:E2:4D:C9	<input type="checkbox"/>
	--	192.168.0.121	28:E0:2C:DC:0A:BE	<input type="checkbox"/>
	--	192.168.0.101	F0:A2:25:AA:8C:C3	<input type="checkbox"/>

A summary and confirmation notification will appear with the automatically configured details. Make a note of the details and click **Yes** to add the camera to your account.

The screenshot shows a dialog box titled 'Confirming New Device'. It asks 'Do you want to add this new device to your mydlink account?'. Below the question, it lists the following details:

- Device Name:** DCS-5000L
- mydlink Number:** 44441252
- Network name (SSID):** dddddd
- Admin Password:** oic953XZ

Below the details, it says 'You can change these default settings by going to **Advanced Settings** after add it to your device list.' At the bottom, there are two buttons: 'Not now' and 'Yes'.



During the Zero Configuration process, you will be directed to the mydlink Live View tab for your camera where you will see a screen similar to the following.

If you wish to connect your camera to your router wirelessly, you can simply disconnect the Ethernet cable and move the camera to its intended location; your router's wireless settings have been automatically transferred to the camera, and no further configuration is required.

Your camera is now set up, and you can skip to **mydlink** on page 25 to learn more about the mydlink features of this camera, or to **Configuration** on page 26 for advanced configuration of your camera.

Note: If the live image is blurry or out of focus, you can manually adjust the focus by rotating the manual focus bezel surrounding the camera lens.

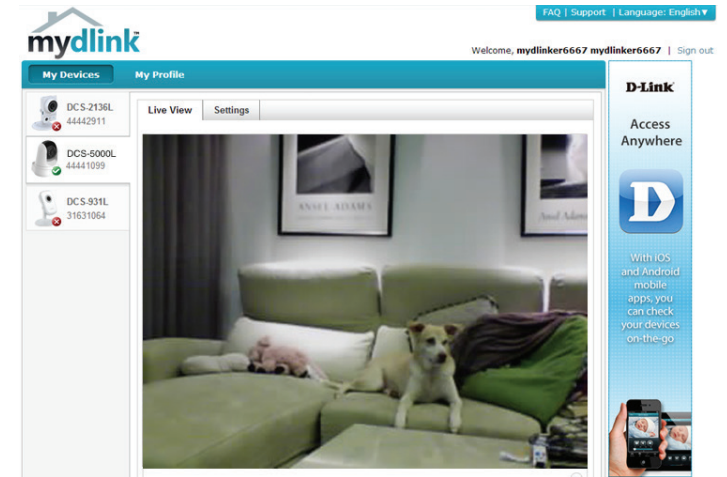

# Camera Setup Wizard

If you do not have a mydlink-enabled cloud router, you can use the Camera Setup Wizard to guide you through the process of adding your camera to the mydlink service.

## Windows Users

To begin the setup process, please go to <http://www.mydlink.com/support> to download the Setup Wizard. Once the file has been downloaded, browse to the folder the file is in and double-click on it to start the wizard. Simply click **Set up your Cloud Camera** to go through the Setup Wizard, which will guide you step-by-step through the installation process from connecting your hardware to configuring your camera and registering it with your mydlink account.

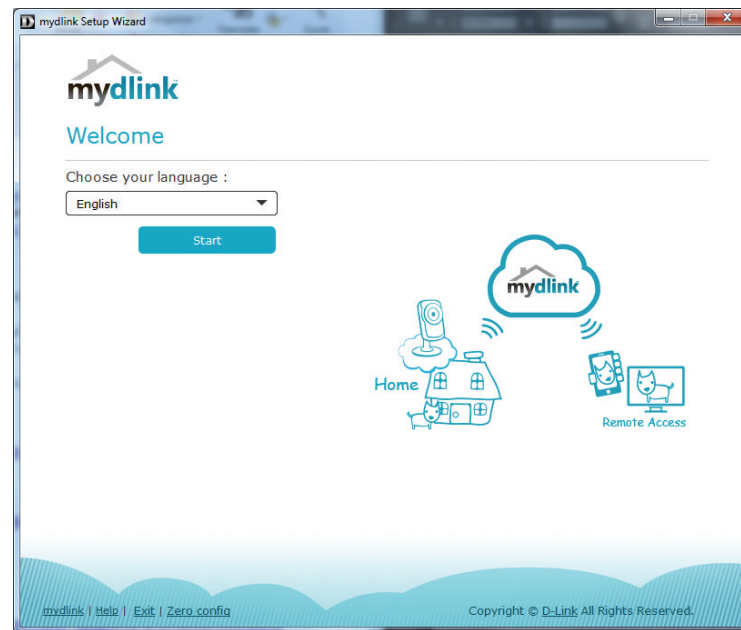

## Mac Users

To begin the setup process, please go to <http://www.mydlink.com/support> to download the Setup Wizard. Once the file has been downloaded, browse to the folder the file is in and double-click on the **SetupWizard** file to **start the wizard**.



After about 20-30 seconds, the Setup Wizard will open, which will guide you step-by-step through the installation process from connecting your hardware to configuring your camera and registering it with your mydlink account.

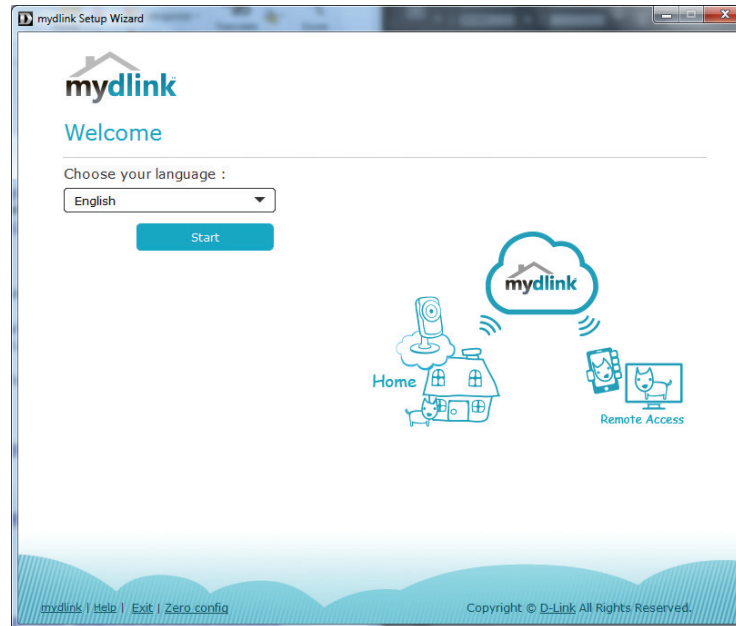

# Manual Hardware Installation

If you wish to set up your camera without using the Camera Setup Wizard, please follow these steps.

**Note:** In order to use the mydlink features of this product, you will need to go through the Camera Setup Wizard or Zero Configuration Setup.

## Connect the Ethernet Cable and the Micro-USB Plug

Use the included Ethernet cable and plug it into the camera. Plug the other end into an available LAN port on your router. Plug one end of the included Micro-USB power adapter to the back of the camera.

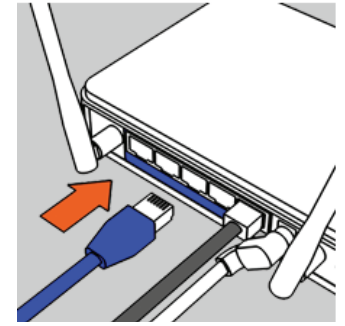
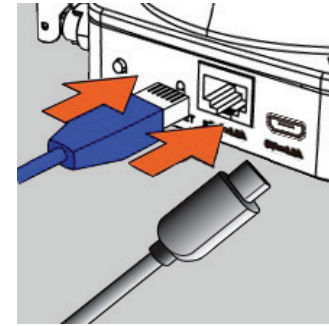

## Plug the Micro-USB Power Adapter to a Wall Outlet

Plug the other end of the Micro-USB power adapter to a wall outlet to power on your camera.

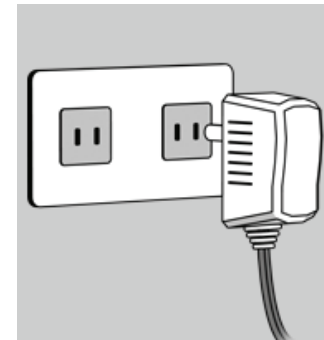

## Configure Your Camera

Refer to **Configuration** on page 26 for information on how to configure your camera.

## Optional: Use WPS to Connect Wirelessly

You can use WPS to connect your camera to your network wirelessly. For more information, refer to **WPS - Push Button Setup** on page 22. If your router does not support WPS, you will still be able to set up your camera's wireless settings in the camera's web interface.

# Wireless Installation Considerations

Your D-Link Wireless Network Camera lets you access your network using a wireless connection from anywhere within the operating range of your wireless network. However, the number, thickness and location of walls, ceilings, or other objects that the wireless signals must pass through, may limit the range. Typical ranges vary depending on the types of materials and background RF (radio frequency) noise in your home or business. The key to maximizing wireless range is to follow these basic guidelines:

1. Minimize the number of walls and ceilings between your adapter and other network devices (such as your Network Camera) - each wall or ceiling can reduce your adapter's range by 1-30 meters (3-90 feet).
2. Be aware of the direct line between network devices. A wall that is half a meter thick (1.5 feet), at a 45-degree angle appears to be almost 1 meter (3 feet) thick. At a 2-degree angle, it can appear over 14 meters (42 feet) thick. Position your devices so that the signal will travel straight through a wall or ceiling (instead of at an angle) for better reception.
3. Building materials make a difference. A solid metal door or aluminum studs may weaken the wireless signal. Try to position your access points, wireless routers, and other networking devices where the signal passes through drywall or open doorways. Materials and objects such as glass, steel, metal, walls with insulation, water (fish tanks), mirrors, file cabinets, brick, and concrete will degrade your wireless signal.
4. Keep your product at least or 1-2 meters (3-6 feet ) away from electrical devices or appliances that generate RF noise.
5. If you are using 2.4 GHz cordless phones or other radio frequency sources (such as microwave ovens), your wireless connection may degrade dramatically or drop completely. Make sure your 2.4 GHz phone base is as far away from your wireless devices as possible. The base transmits a signal even if the phone is not in use.

# WPS - Push Button Setup

If your router supports Wi-Fi Protected Setup (WPS), you can create a secure wireless connection using the WPS Button on the back of the camera. Please note that WPS setup only establishes a secure wireless connection, and you will still need to run the Setup Wizard to configure your camera.

## To create a WPS connection:

### Step 1

Make sure the camera is plugged in, then press and hold the WPS button for ten seconds. The blue WPS status LED will start blinking.

### Step 2

Press the WPS button on your router within 60 seconds. The WPS button is usually on the front or side of your router. On some routers, you may need to log in to the web interface and click on an on-screen button to activate the WPS feature. If you are not sure where the WPS button is on your router, please refer to your router's User Manual.

The DCS-5000L will automatically create a secure wireless connection to your router. While connecting, the blue LED will flash and your camera will reboot.

**Note:** You can also set up a wireless connection manually; please see **Wireless Setup** on page 34.



# Mounting Instructions

To mount your camera on a wall or ceiling, please follow the steps below.

**1** It is suggested that you configure the camera before mounting.

Place the mounting bracket where you want to position the camera and use a pencil to mark the holes.

Use appropriate tools to drill two holes the same diameter as the plastic anchors. After drilling the holes, insert the plastic anchors to support the screws.

If desired, the power and Ethernet cables can be concealed behind the mounting bracket. Run the cables through the back of the mounting bracket, securing them with the built-in guides. Be sure to leave enough cable length protruding from the top to allow connection to the camera.

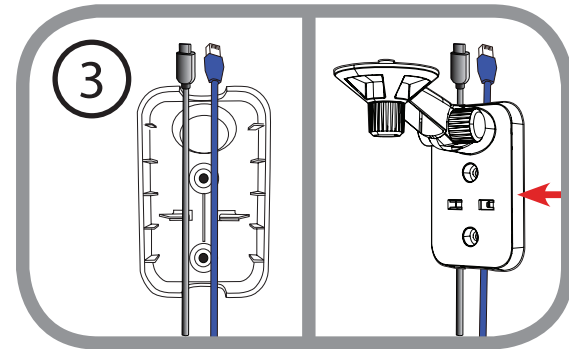
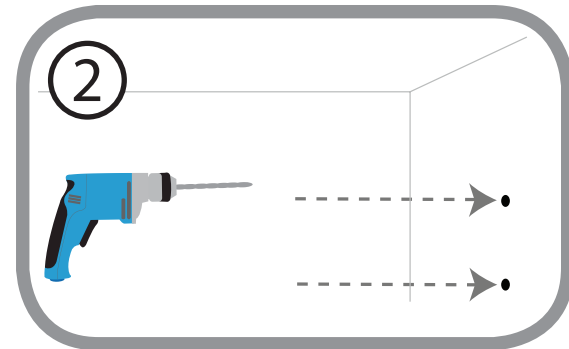
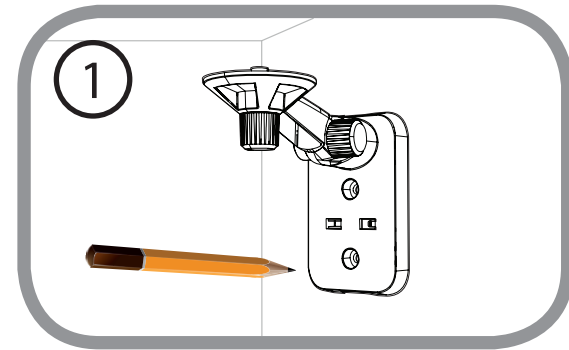

Fasten the mounting bracket to the wall using the screws provided.

 Do not overtighten the screws as this may crack the mounting bracket.

Using the supplied thumbscrew, fasten the camera to the mounting bracket. Connect the power and Ethernet cables to the camera.

Adjust the angle of the arm on the mounting bracket as required. Tighten the thumbscrew to lock the arm in place.

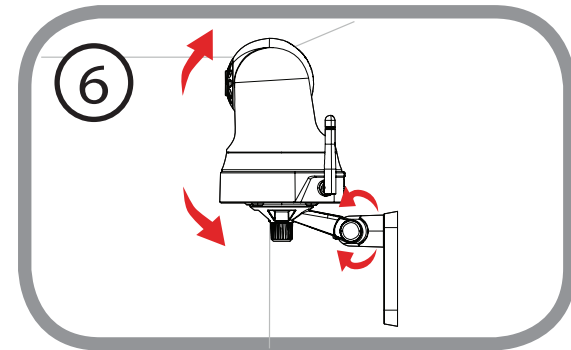
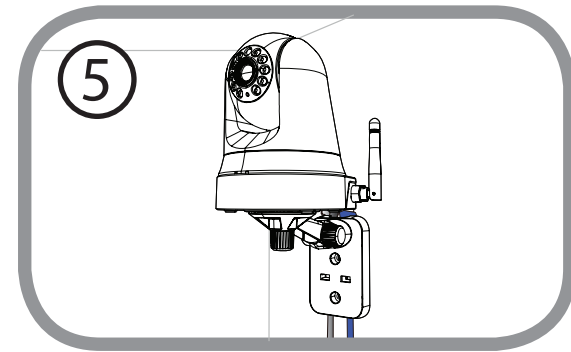
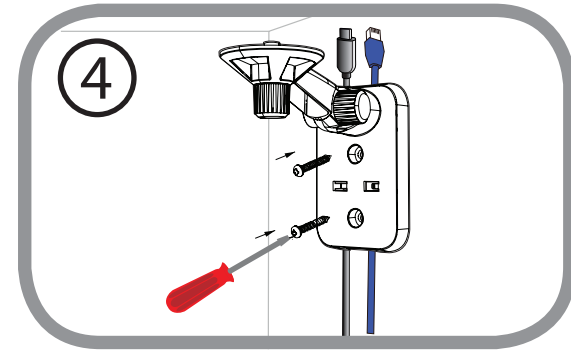



# mydlink

After registering your DCS-5000L camera with a mydlink account in the Camera Installation Wizard, you will be able to remotely access your camera from the [www.mydlink.com](http://www.mydlink.com) website. After signing in to your mydlink account, you will see a screen similar to the following:

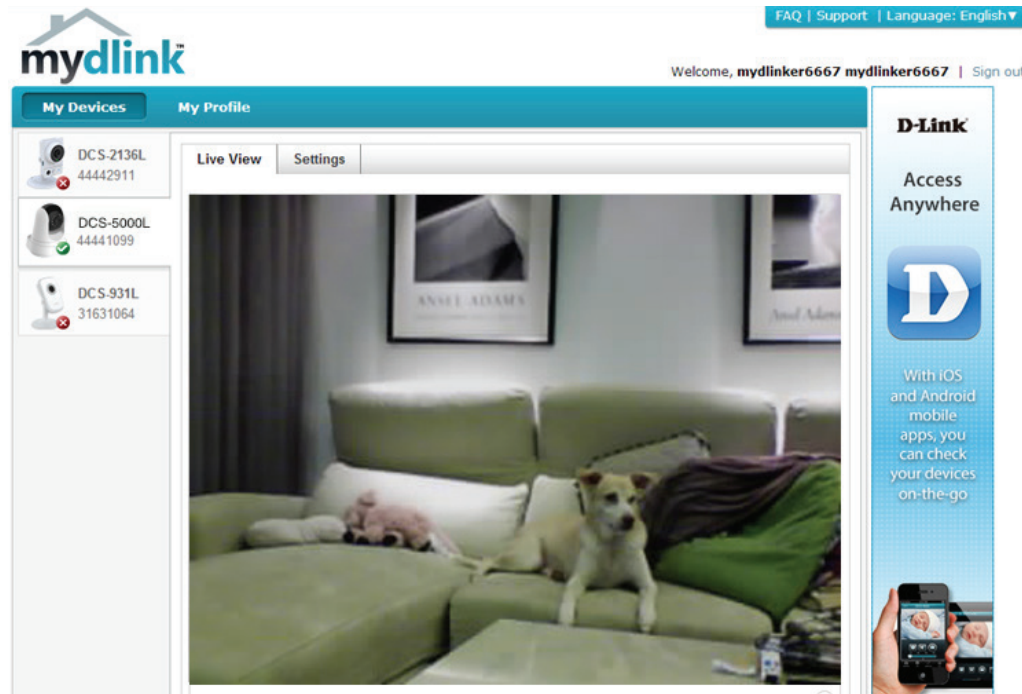

# Configuration

## Using the Web Configuration Interface

After completing the Camera Installation Wizard, your camera is ready to use. The camera's built-in web configuration interface is designed to allow you to easily access and configure your DCS-5000L. There are two ways in which you can access your camera's web configuration interface:

- Log in to your mydlink account to access your camera's configuration interface.
- You can also access the interface locally by entering the IP address of your camera into a web browser, such as Internet Explorer®. To log in, use the User name **admin** and the password you created in the Installation Wizard. If you did not create a password, leave the password field blank. After entering your password, click **OK**.

**Note:** If you are directly connecting your camera to your PC, or if you are using the camera on a closed network, the default IP is **192.168.0.20**. If the camera is connected to a router or network, a different IP address may have been assigned.

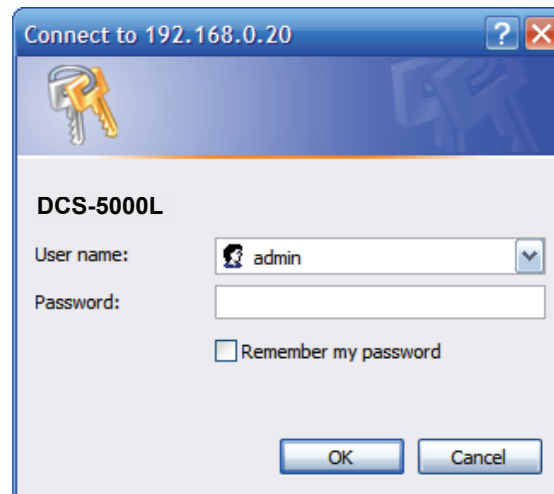

# Live Video

The Live Video screen shows you the live video feed from your camera. Click on **ActiveX** or **Java** to enable live streaming. You may need to install the selected plug-in for your browser. If a pop-up asks for permission to run the plug-in, click to allow it. For information on how to configure your Live Video streams, refer to **Video** on page 37.

**Video Compression Format:** Click the **MJPEG** radio button to choose the format stream to view.

**Format:**

**Pan/Tilt Controls:** Click on the directional arrows on the pan/tilt wheel to manually control the pan and tilt functions of the camera. At any time, you can click the home button in the center of the wheel to return the camera to its home position.

**Go To:** Select one of the preset locations from the drop-down menu to move the camera to that position. Preset positions can be set by going to the **Camera Control** section of the **Setup** menu.

**Pan Step:** Select the increment of horizontal movement for each press of a pan (up/down) arrow on the pan/tilt wheel.

**Tilt Step:** Select the increment of vertical movement for each press of a tilt (left/right) arrow on the pan/tilt wheel.

**Language:** You can select the desired language for the web interface from this drop-down menu.

**Zoom:** Click on these buttons to adjust the level of digital zoom applied to the image.

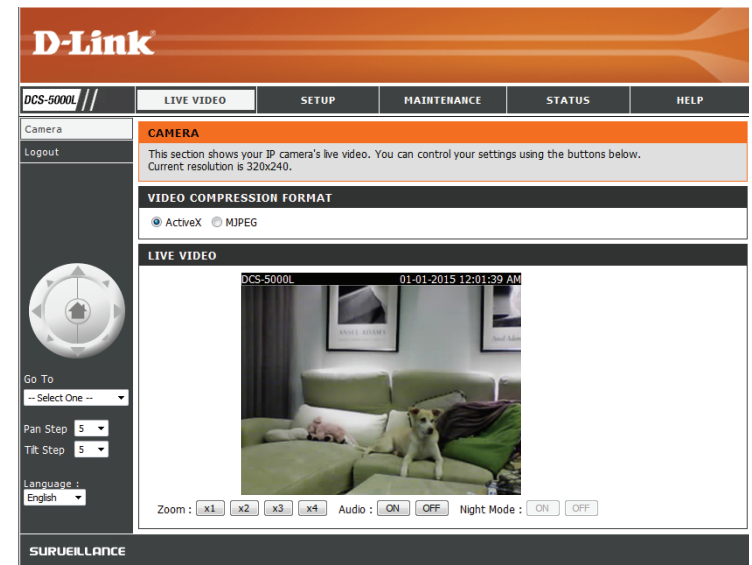

**Audio:** Click on these buttons to turn audio playback on and off.

**Night Mode:** If you have set the night mode to manual, the night mode feature can be toggled using these buttons.

**Note:** If the live image is blurry or out of focus, you can manually adjust the focus by rotating the manual focus bezel surrounding the camera lens.

The screenshot displays the D-Link DCS-5000L web interface. At the top, the D-Link logo is visible. Below it, a navigation bar includes tabs for LIVE VIDEO, SETUP, MAINTENANCE, STATUS, and HELP. The main content area is divided into several sections:

- Camera:** A section with a 'Logout' link and a 'CAMERA' title. Below the title, a message states: "This section shows your IP camera's live video. You can control your settings using the buttons below. Current resolution is 320x240."
- VIDEO COMPRESSION FORMAT:** A section with two radio buttons:  ActiveX and  MJPEG.
- LIVE VIDEO:** A section containing a live video feed. The video shows a room with a green sofa and a dog. The video title is "DCS-5000L" and the timestamp is "01-01-2015 12:01:29 AM". Below the video, there are controls for Zoom (x1, x2, x3, x4), Audio (ON, OFF), and Night Mode (ON, OFF).

On the left side of the interface, there is a 'Go To' dropdown menu (set to "-- Select One --"), 'Pan Step' and 'Tilt Step' dropdown menus (both set to '5'), and a 'Language' dropdown menu (set to 'English'). A manual focus bezel is also visible on the left side of the video feed.

# Setup Wizard

You may choose to configure your Internet connection by using the **Internet Connection Setup Wizard** that includes step-by-step instructions. Otherwise, you may manually configure your connection using the **Manual Internet Connection Setup**.

**Note:** To register your camera with mydlink and enable its mydlink-related features, you will need to use the Camera Installation Wizard. Please refer to **Camera Setup Wizard** on page 18 for more details.

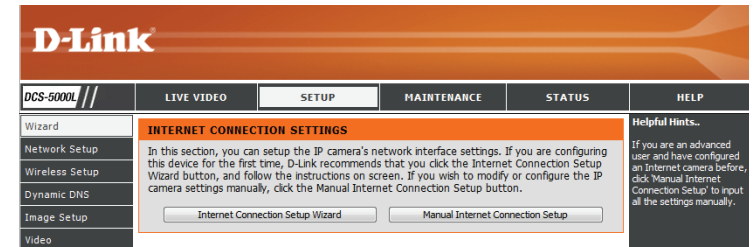

## Internet Connection Setup Wizard

This wizard will guide you through a step-by-step process to configure your new D-Link Camera and connect the camera to the Internet.

Click **Next** to continue.

Select what kind of Internet connection your camera should use:

- **DHCP Connection (Default):** If you are connected to a router, or are not sure which connection to use, select DHCP Connection.
- **Static IP Address:** This will allow you to manually enter your network settings for the camera. Select this option if your Internet Service Provider or network administrator has provided you with a set of predefined IP addresses. If you are not sure what settings to enter, check with your Internet Service Provider or network administrator.
- **PPPoE Connection:** If your camera is directly connected to a DSL modem, you may need to use PPPoE. Enter the username and password provided to you by your Internet Service Provider.

Click **Next** to continue.

### WELCOME TO D-LINK SETUP WIZARD - INTERNET CONNECTION SETUP

This wizard will guide you through a step-by-step process to configure your new D-Link Camera and connect the camera to the internet.

- **Step 1:** Setup LAN Settings
- **Step 2:** Setup DDNS Settings
- **Step 3:** Server Name Settings
- **Step 4:** Setup Time Zone

[Back](#) [Next](#) [Cancel](#)

### STEP 1: SETUP LAN SETTINGS

Please select whether your camera will connect to the Internet with a DHCP connection, Static IP address or PPPoE. If your camera is connected to a router, or you are unsure which settings to pick, D-Link recommends that you keep the default selection of DHCP connection. Otherwise, click on Static IP address to manually assign an IP address before clicking on the **Next** button.

DHCP Connection

Static IP Address

IP Address

Subnet Mask

Default Gateway

PPPoE

User ID

Password

Primary DNS

Secondary DNS

[Back](#) [Next](#) [Cancel](#)

If you have a Dynamic DNS account and would like the camera to update your IP address automatically, select **Enable** and enter your host information. Otherwise, simply select **Disable**.

Click **Next** to continue.

Enter a name for your camera. Click **Next** to continue.

Configure the correct time to ensure that all events are triggered, captured, and scheduled at the right time. Click **Next** to continue.

This page displays your configured settings. Click **Apply** to save and activate your changes, or click **Back** to change your settings.

**STEP 2: SETUP DDNS SETTINGS**

If you have a Dynamic DNS account and would like your camera to update the IP address automatically, enable DDNS and enter your host information below. Click on the **Next** button to continue.

Enable  
 Disable

Server Address  <<

Host Name

User Name

Password

Timeout  hours

**STEP 3: SERVER NAME SETTINGS**

D-Link recommends that you rename your camera for easy accessibility. Please assign a name of your choice before clicking on the **Next** button.

Camera Name

**STEP 4: SETUP TIME ZONE**

Please select the camera's timezone and then click on the **Next** button.

Current Time 01 Jan 2012 12:37:14 A.M.

Time Zone

**STEP 5: SETUP COMPLETE**

Here is a summary of your camera settings. Click **Back** to modify the settings, or click **Apply** if all settings are correct. It is recommended you write down this information for future access or reference.

IP Address	DHCP Connection
IP Camera Name	DCS-5000L
Time Zone	(GMT-12:00) International Date Line West
DDNS	Disable

# Network Setup

This section allows you to configure your network settings.

**DHCP:** Select this connection if you have a DHCP server running on your network and would like a dynamic IP address to be assigned to your camera automatically.

**Static IP Client:** Select this connection type if your Internet Service Provider (ISP) or network administrator has provided you with a static or fixed IP address and other network information for your camera. Click on the **Static IP Address** radio button to activate this method.

**IP Address:** The fixed IP address

**Subnet Mask:** The default value is "255.255.255.0." Used to determine if the destination is the same subnet.

**Default Gateway:** The gateway used to forward data to destinations in a different subnet. Invalid gateway settings may cause the failure of transmissions to a different subnet.

**Primary DNS:** Primary domain name server that translates names to IP addresses.

**Secondary DNS:** Secondary domain name server to backup the Primary DNS.

**PPPoE:** If you need to connect to the Internet using a PPOE connection, click on the **PPPoE** radio button and enter the username and password provided to you by your Internet Service Provider or Network Administrator.

**D-Link**

DCS-5000L // LIVE VIDEO SETUP MAINTENANCE STATUS HELP

**NETWORK SETUP**  
You can configure your LAN and Internet settings here.  
Save Settings Don't Save Settings

**LAN SETTINGS**

DHCP Connection  Static IP Address  PPPoE

IP Address  User ID

Subnet Mask  Password

Default Gateway

Primary DNS

Secondary DNS

**PORT SETTINGS**

HTTP Port

**UPnP SETTINGS**

UPnP  Enable  Disable

UPnP Port Forwarding  Enable  Disable

**BONJOUR SETTINGS**

Bonjour  Enable  Disable

Bonjour Name   
(Characters you may use in a Bonjour Name: "upper or lower case letters", "numbers" and "hyphens".)

Save Settings Don't Save Settings

**Helpful Hints...**  
Select "DHCP Connection" if you are running a DHCP server on your network and would like an IP address assigned to your camera automatically. You may choose to manually enter a Static IP Address and all the relevant network information or select PPPoE. If you connect your DCS-5000L directly to the Internet that uses a PPPoE service, if you choose PPPoE you must enter the user ID and password that was given by your Internet Service Provider.  
  
DNS (Domain Name System) server is an Internet service that translates domain names (i.e. www.dlink.com) into IP addresses (i.e. 192.168.0.20). The IP addresses can be obtained from your ISP.  
- **Primary DNS:** Primary domain name server that translates names to IP addresses.  
- **Secondary DNS:** Secondary domain name server to backup the primary one.  
  
Port Settings - Most ISPs do not open port 80 (a DCS-5000L default video transfer port) for their residential customers, the DCS-5000L has the ability to use a different port by enabling the second http port for its video streaming. Any unused



**Port Settings:** You may configure a second HTTP port that will allow you to connect to the camera via a standard web browser. The port can be set to a number other than the default TCP port of 80. A corresponding port must be opened on the router. For example, if the port is changed to 1010, users must type **http://192.168.0.100:1010** instead of only "http://192.168.0.100".

**UPnP Settings:** Enable this setting to configure your camera as a UPnP device in the network. You can also enable UPnP port forwarding.

**Bonjour Settings:** Enable this setting to allow your camera to be discovered by the Bonjour service. You can also specify a Bonjour name for the device.

LAN SETTINGS		
<input checked="" type="radio"/> DHCP Connection	<input type="radio"/> Static IP Address	<input type="radio"/> PPPoE
IP Address	<input type="text" value="192.168.0.20"/>	User ID <input type="text"/>
Subnet Mask	<input type="text" value="255.255.255.0"/>	Password <input type="text"/>
Default Gateway	<input type="text"/>	
Primary DNS	<input type="text"/>	
Secondary DNS	<input type="text"/>	

PORT SETTINGS	
HTTP Port	<input type="text" value="80"/>

UPnP SETTINGS	
UPnP	<input checked="" type="radio"/> Enable <input type="radio"/> Disable
UPnP Port Forwarding	<input type="radio"/> Enable <input checked="" type="radio"/> Disable

BONJOUR SETTINGS	
Bonjour	<input checked="" type="radio"/> Enable <input type="radio"/> Disable
Bonjour Name	<input type="text" value="DCS-5000L"/> <small>(Characters you may use in a Bonjour Name: "upper or lower case letters", "numbers" and "hyphens".)</small>

# Wireless Setup

This section allows you to set up and configure the wireless settings on your camera.

**Enable Wireless:** Check this box to allow your camera to connect to your network wirelessly.

**SSID:** Enter the network name (SSID) of the wireless network you want to connect to. You can also click the **Site Survey** button below to choose an available network and fill in settings automatically.

**Channel:** If you are using **Ad-Hoc** as your connection mode, select the same channel that is being used by your wireless network.

**Connection Mode:** Select the connection mode used by your wireless network.

In most cases, you should select **Infrastructure**. **Ad-Hoc** is only used if your camera is directly connecting to another PC or device without the use of a router or access point.

**Site Survey:** Clicking this button will allow you to select an available wireless network to connect to, and will fill in the necessary settings for you.

**Wireless Security Mode:** Select the wireless security mode used by your wireless network. If you select WEP or WPA-PSK/WPA2-PSK, enter the password for your wireless network in the text box that appears.

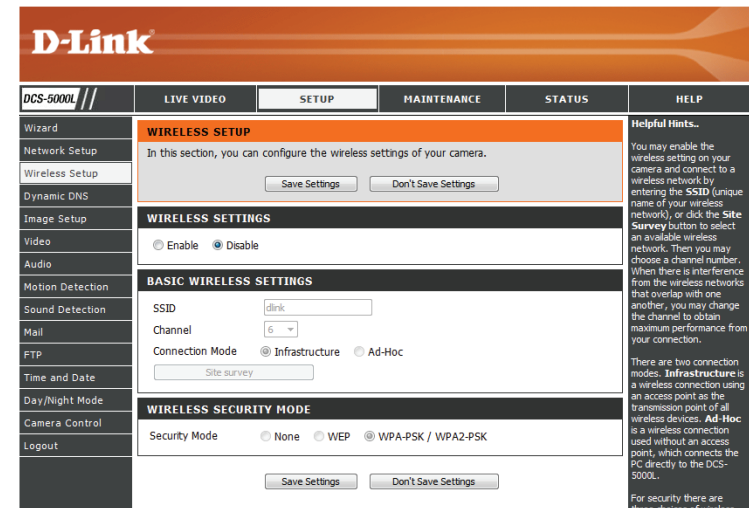

## Dynamic DNS (DDNS)

This section allows you to configure the DDNS setting for your camera. DDNS will allow all users to access your camera using a domain name instead of an IP address.

**Enable:** Click to enable the DDNS function.

**Server Address:** Select your Dynamic DNS Server from the pull-down menu.

**Host Name:** Enter the host name of the DDNS server.

**User Name:** Enter your username or email used to connect to the DDNS.

**Password:** Enter your password used to connect to the DDNS server.

**Timeout:** This allows you to specify the periodic update time for the DDNS address.

**D-Link**

DCS-5000L // LIVE VIDEO SETUP MAINTENANCE STATUS HELP

Wizard

Network Setup

Wireless Setup

Dynamic DNS

Image Setup

Video

Audio

Motion Detection

Sound Detection

Mail

FTP

Time and Date

Day/Night Mode

Camera Control

Logout

**DYNAMIC DNS**

The Dynamic DNS feature allows you to host a server (Web, FTP, Camera, etc...) using a domain name that you have purchased (www.whateveryournameis.com) from your broadband Internet Service Provider (ISP). Using a DDNS service, your friends can enter your host name to connect to your IP Camera regardless of your IP address.

Save Settings Don't Save Settings

**DYNAMIC DNS SETTINGS**

Enable  Disable

Server Address << Select Dynamic DNS Server

Host Name

User Name

Password

Timeout 576 hours

Save Settings Don't Save Settings

Helpful Hints...

Dynamic DNS is useful if you have a DSL or Cable service provider that changes your modem IP address periodically. This will allow you to assign a website domain name to your camera instead of connecting through an IP address.

SURUEILLANCE

# Image Setup

This section allows you to configure the image settings for your camera.

**Enable Anti-flicker:** If you have lights flickering in your camera video, try enabling anti-flicker. Otherwise, you should leave this disabled.

**Flip Image:** Select this box to vertically flip the video.

**Mirror:** Horizontally flip the video.

**Note:** If the camera is installed upside down, Flip Image and Mirror should both be checked.

**Brightness Control:** Allows you to adjust the brightness level. Select a setting between -5 and +5.

**Contrast Control:** Allows you to adjust the contrast level. Select a setting between -5 and +5.

**Saturation Control:** Allows you to adjust the saturation level. Select a setting between -5 and +5.

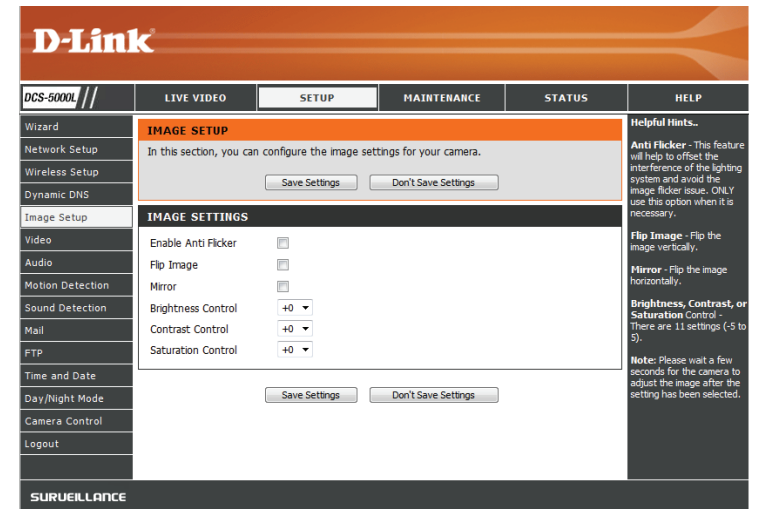

# Video

This section allows you to configure the video settings for your camera.

**Video Profile:** This section allows you to change the **Resolution, FPS, Quality, and View Mode.**

**Encode Type:** Your camera is set to the MJPEG video stream by default.

**Resolution:** Select the desired video resolution from three formats: **640 x 480, 320 x 240, and 160 x 120.** Higher settings offer better quality, but will require more bandwidth to stream.

**FPS:** Select the frame rate (FPS) to use for the video stream. Higher settings offer better quality, but will require more bandwidth to stream. Use **Auto** if you are unsure.

**JPEG Quality:** Select one of five levels of image quality: **Very High, High, Medium, Low, and Very Low.**

**View Mode:** Select the default plug-in to use when viewing your video on the **Live Video** page.

**Light Frequency:** Select the frequency used by your lighting and power to help reduce image flicker.

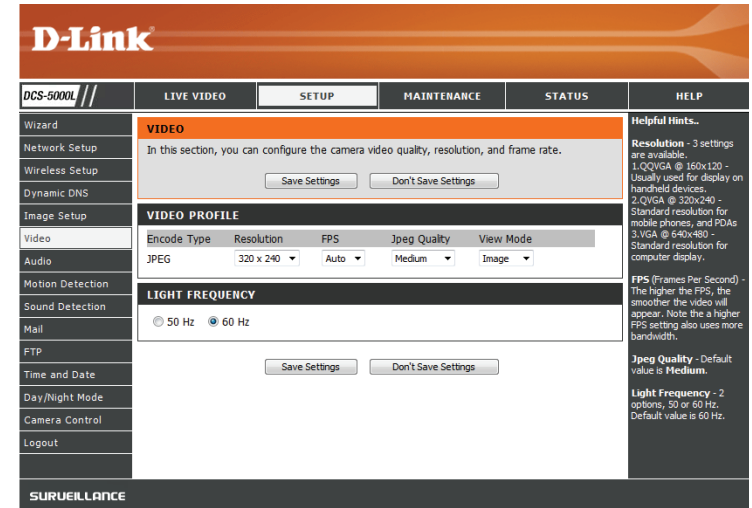

# Audio

This section allows you to adjust the audio settings for your camera.

**Note:** Please wait a few seconds for the camera to adjust the audio after making changes.

**Audio Settings:** You may **Enable** or **Disable** the camera audio feed.

**Volume Settings:** Select the desired volume percentage level.

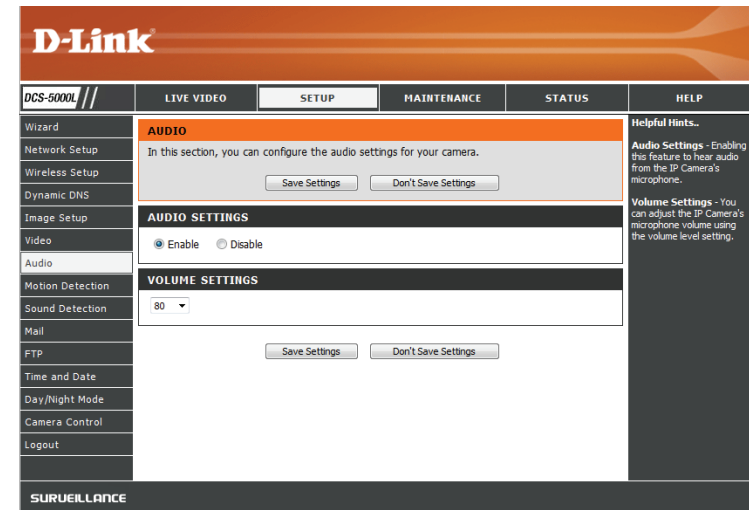

# Motion Detection

Motion detection allows you to mark areas of your camera's video to monitor for motion, which can be used to trigger snapshots or recordings. Refer to **Mail** on page 41 and **FTP** on page 44 for more details.

**Motion Detection:** Select whether you want to enable or disable the motion detection feature of your camera.

**Time:** Specify whether you want to **Always** have motion detection enabled, or according to a **Schedule** that you define.

**Sensitivity:** Specify the amount of difference required to determine whether there was motion.

**Detection Areas:** Use your mouse to click on the areas of the video that you would like to monitor for motion.

**D-Link**

DCS-5000L // LIVE VIDEO SETUP MAINTENANCE STATUS HELP

**MOTION DETECTION**

In this section, you can configure the motion detection settings for your camera.  
Please note that your computer needs to have Java installed in order to view the motion detection configuration window. If you do not see the live video below, please visit <http://www.java.com> to download and install Java.

Save Settings Don't Save Settings

**MOTION DETECTION SETTINGS**

Motion Detection  Enable  Disable

Time

Always

Schedule

Day  Mon  Tue  Wed  Thu  Fri  Sat  Sun

Time Period Start : 00:00:00 (Example : 06:30:00)

Stop : 00:00:00 (Example : 22:30:00)

Sensitivity 90 % (0~100%, high sensitivity makes the motions easier to be detected.)

Detection Areas Use mouse to click the blocks where you want to monitor for motion.

Save Settings Don't Save Settings

SURVEILLANCE

# Sound Detection

Sound detection allows you to adjust your camera to monitor for sound, which can be used to trigger snapshots or recordings. Refer to **Mail** on page 41 and **FTP** on page 44 for more details.

**Sound Detection:** Select whether you want to enable or disable the motion detection feature of your camera.

**Time:** Specify whether you want to **Always** have motion detection enabled, or according to a **Schedule** that you define.

**Detection Level:** Specify the amount of decibels required to determine whether to trigger recording.

**D-Link**

DCS-5000L // LIVE VIDEO SETUP MAINTENANCE STATUS HELP

**SOUND DETECTION**

In this section, you can configure the sound detection settings for your camera.  
Please note that your computer needs to have Java installed in order to view the sound dB/Time window. If you do not see the sound dB/Time window below, please visit <http://www.java.com> to download and install Java.

Save Settings Don't Save Settings

**SOUND DETECTION SETTINGS**

Sound Detection  Enable  Disable

Time

Always

Schedule

Day  Mon  Tue  Wed  Thu  Fri  Sat  Sun

Time Period Start : 00:00:00 (Example : 06:30:00)

Stop : 00:00:00 (Example : 22:30:00)

Detection Level 90 dB

db

100  
90  
80  
70  
60  
50  
40

Time

Save Settings Don't Save Settings

SURVEILLANCE



# Mail

This section allows you to configure your camera to send snapshots to an e-mail address. If you are not sure what settings to use, check with your e-mail service provider.

**SMTP Server Address:** This is the domain name or IP address of your external e-mail server.

**SMTP Server Port:** This allows you to set the port for the SMTP Server. The default value is 25, and should only be changed if advised by your e-mail provider.

**Sender e-mail Address:** This is the e-mail address listed as the sender for your notification e-mails.

**Receiver e-mail Address:** This is the e-mail address that your notification e-mails will be sent to.

**User Name:** If the SMTP server uses authentication, enter your user name.

**Password:** If the SMTP server uses authentication, enter your password.

For example, if you want to use Gmail with SSL-TLS for e-mail notifications, you can follow the setup procedure as below:

**Step 1** - Enter "smtp.gmail.com" in SMTP Server Address.

**Step 2** - Change the SMTP server port number from 25 to **465**.

**Step 3** - Enter your gmail e-mail address in Sender E-mail Address.

**D-Link**

DCS-5000L // LIVE VIDEO SETUP MAINTENANCE STATUS HELP

**MAIL**

This section allows you to setup and configure the email notification settings for your camera. If your details change or you are experiencing issues with alert notifications, you may need to modify these settings.

Save Settings Don't Save Settings

**E-MAIL ACCOUNT**

SMTP Server Address

SMTP Server Port 25 (Default is 25)

Sender E-mail Address

Receiver E-mail Address

User Name

Password

Use SSL-TLS/STARTTLS  No  SSL-TLS  STARTTLS

**TIME SCHEDULE**

Enable the emailing of images to an email account

Always

Schedule

Day  Mon  Tue  Wed  Thu  Fri  Sat  Sun

Time Period Start: 00:00:00 (Example : 06:30:00)

Stop: 00:00:00 (Example : 22:30:00)

Motion/Sound Detection

E-mail frame immediately

E-mail attached with 6 frames (3 frames before and 3 frames after detection)

Frame interval time: 1 second

E-mail Interval 300 Seconds

**TEST E-MAIL ACCOUNT**

A test e-mail will be sent to the e-mail account listed above. Test

Save Settings Don't Save Settings

**Helpful hints.**

**SMTP Server Address:** This is the domain name or IP address of your external email server.

**Sender E-mail Address:** This is the email address of the person sending the camera snapshots.

**Receiver E-mail Address:** This is the email address of recipient for the SMTP server.

**User Name:** The user name of your email account.

**Password:** The password of your email account.

**Use SSL-TLS/STARTTLS:** Select SSL-TLS or STARTTLS if SMTP server requires TLS authentication.

**Enable the emailing of images to an email account:** Select Always to enable the camera to always send images to the recipient's email account. Select Schedule if you would like to specify the time and day when the camera will start and stop sending images to the recipient's email account. The interval of the snapshot can be configured from 1 to 65535 seconds. Select Motion/Sound Detection if you would like the camera to send images to the recipient's email account only when motion/sound is detected.

**SURVEILLANCE**

**Step 4** - Enter the destination e-mail address in Receiver E-mail Address.

**Step 5** - Enter the user name required to access the SMTP server.

**Step 6** - Enter the password required to access the SMTP server.

**Step 7** - Select **SSL-TLS** and then click **Save Settings**.

**Step 8** - Click the **Test** button to send a test e-mail to the account listed above.

**Note:** You can also use **STARTTLS**, which will use SMTP server port number **587**.

**Note:** If you want to use a Yahoo SMTP server, the SMTP server address will be different between each registered region, and only SMTP port **465** is supported for **SSL-TLS**.

**Enable the e-mailing of images to an e-mail account:** Enabling this will allow snapshots to be e-mailed to you in different ways:

- Choosing **Always** will e-mail snapshots continuously based on the **E-mail Interval** specified.
- Choosing **Schedule** will allow you to schedule when to start and stop the e-mailing of snapshots.
- Select **Motion/Sound Detection** if you would like the camera to e-mail images only when motion or sound is detected. You can choose whether to e-mail a snapshot immediately, or e-mail 6 snapshots together, with 3 frames before and after motion/sound was detected. You can also set the **Frame interval time** to specify how far apart the snapshots should be.

**E-MAIL ACCOUNT**

SMTP Server Address	<input type="text"/>	
SMTP Server Port	<input type="text" value="25"/>	(Default is 25)
Sender E-mail Address	<input type="text"/>	
Receiver E-mail Address	<input type="text"/>	
User Name	<input type="text"/>	
Password	<input type="password"/>	
Use SSL-TLS/STARTTLS	<input checked="" type="radio"/> No <input type="radio"/> SSL-TLS <input type="radio"/> STARTTLS	

---

**TIME SCHEDULE**

Enable the emailing of images to an email account

**Always**

**Schedule**  
 Day     Mon    Tue    Wed    Thu    Fri    Sat    Sun  
 Time Period Start :  (Example : 06:30:00)  
                      Stop :  (Example : 22:30:00)

**Motion/Sound Detection**  
 E-mail frame immediately  
 E-mail attached with 6 frames (3 frames before and 3 frames after detection)  
 Frame interval time :  second

E-mail Interval  Seconds

---

**TEST E-MAIL ACCOUNT**

A test e-mail will be sent to the e-mail account listed above.

**E-mail Interval:** This sets the limit for how frequently e-mail notifications will be sent. This can be set from 1 to 65535 seconds.

**Test E-mail Account:** This will send a test e-mail according to the e-mail settings you have specified above.

**E-MAIL ACCOUNT**

SMTP Server Address	<input type="text"/>
SMTP Server Port	<input type="text" value="25"/> (Default is 25)
Sender E-mail Address	<input type="text"/>
Receiver E-mail Address	<input type="text"/>
User Name	<input type="text"/>
Password	<input type="password"/>
Use SSL-TLS/STARTTLS	<input checked="" type="radio"/> No <input type="radio"/> SSL-TLS <input type="radio"/> STARTTLS

**TIME SCHEDULE**

Enable the emailing of images to an email account

Always

Schedule

Day  Mon  Tue  Wed  Thu  Fri  Sat  Sun

Time Period Start :  (Example : 06:30:00)

Stop :  (Example : 22:30:00)

Motion/Sound Detection

E-mail frame immediately

E-mail attached with 6 frames (3 frames before and 3 frames after detection)

Frame interval time :  second

E-mail Interval  Seconds

**TEST E-MAIL ACCOUNT**

A test e-mail will be sent to the e-mail account listed above.

# FTP

This section allows you to configure your camera to send snapshots to an FTP server.

**Host Name:** Enter the IP address of the FTP server that you will be connecting to.

**Port:** Enter the port of the FTP server that you will be connecting to.

**User Name:** Enter the user name of your FTP server account.

**Password:** Enter the password of your FTP server account.

**Path:** Enter the destination path/folder to save files to on the FTP server.

**Passive Mode:** Enabling passive mode may help you reach your FTP server if your camera is behind a router protected by a firewall.

**Enable the uploading of images to an FTP server:** Enabling this will allow snapshots to be uploaded in different ways:

- Choosing **Always** will upload snapshots continuously based on the **Image Frequency** specified.
- Choosing **Schedule** will allow you to schedule when to start and stop the uploading of snapshots.
- Select **Motion/Sound Detection** if you would like the camera to upload images only when motion is detected.

**D-Link**

DCS-5000L // LIVE VIDEO SETUP MAINTENANCE STATUS HELP

Wizard  
Network Setup  
Wireless Setup  
Dynamic DNS  
Image Setup  
Video  
Audio  
Motion Detection  
Sound Detection  
Mail  
FTP  
Time and Date  
Day/Night Mode  
Camera Control  
Logout

**FTP**

In this section, you can configure the camera to send images to an FTP server.

Save Settings Don't Save Settings

**FTP SERVER**

Host Name  
Port 21 (Default is 21)  
User Name  
Password  
Path /  
Passive Mode  Yes  No

**TIME SCHEDULE**

Enable uploading of images to an FTP server

Always  
 Schedule  
Day  Mon  Tue  Wed  Thu  Fri  Sat  Sun  
Time Period Start : 00:00:00 (Example : 06:30:00)  
Stop : 00:00:00 (Example : 22:30:00)  
 Motion/Sound Detection

Image Frequency 1 Frames/Second  
Base File Name DCS-5000L  
File  Overwrite  
 Date/Time Suffix  
 Create subfolder by 0.5 hour  
 Sequence Number Suffix Up to 1024

**TEST FTP SERVER**

A JPEG file will be sent to the above FTP server for testing.  
(File name: test\_date\_time.jpg) Test

Save Settings Don't Save Settings

**Helpful Hints...**

**Host Name:**  
This is the IP address of the FTP server that you will be connecting to.

**Port:**  
The default port is 21.

**User Name:**  
The user name required for accessing the external FTP server.

**Password:**  
The password of the external FTP server.

**Passive mode:** Enabling passive mode will allow access to an external FTP server if your camera is behind a router protected by a firewall.

**Enable uploading of images to an FTP server:**  
Checking this box will enable the camera to upload images to FTP server shown above. Select **Always** to enable the camera to always upload images to the FTP server. Select **Schedule** if you would like to specify the time and day when the camera starts and stops uploading images to the FTP server. Select **Motion/Sound Detection** if you would like the camera to upload images to the FTP server only when motion/sound is detected.

**Image Frequency - User** can choose and define the numbers for both **Frames/Second** and **Seconds/Frame**.

**Base File Name -** The name that contains the time stamp information. For example DCS-5000L\_2012072116425101.jpg. This means that the camera took a snapshot in the year

**Image Frequency:** Set how frequently you want images to be taken and uploaded. You can choose to upload by frames per second, or by seconds per frame.

**Base File Name:** Set the desired base file name for your snapshots.

**File:** Select how you want uploading of snapshots to be handled:

- **Overwrite** will replace the old snapshot with the new one. This means you will only have one snapshot that is updated every time a new one is taken.
- **Date/Time Suffix** will add the date and time to the end of the snapshot file name. You can also choose to make subfolders based on a period of time you specify to help you organize your snapshots.
- **Sequence Number Suffix** will add a number to the end of the snapshot file name up to the number you specify, after which the oldest files will be overwritten.

**Test FTP Server:** Clicking on the **Test** button will send a test JPEG snapshot to the FTP server specified above to make sure that your settings are correct.

**TIME SCHEDULE**

Enable uploading of images to an FTP server

Always

Schedule

Day  Mon  Tue  Wed  Thu  Fri  Sat  Sun

Time Period Start :  (Example : 06:30:00)

Stop :  (Example : 22:30:00)

Motion/Sound Detection

Image Frequency  1 Frames/Second

1 Seconds/Frame

Base File Name

File

Overwrite

Date/Time Suffix

Create subfolder by

Sequence Number Suffix Up to

**TEST FTP SERVER**

A JPEG file will be sent to the above FTP server for testing.  
(File name: test\_date\_time.jpg)

# Time and Date

This section allows you to configure the settings of the internal system clocks for your camera.

**Time Zone:** Select the time zone for your region from the drop-down menu.

**Synchronize NTP Server:** Enabling this will allow the camera to update its clock automatically from an NTP server. Select the NTP server closest to you, and select whether you want to apply daylight saving corrections.

**Set the Date and Time Manually:** If Synchronize NTP Server is disabled, you can set the date and time manually. You can also click on **Copy Your Computer's Time Settings** to automatically set the date and time based on your computer's settings.

The screenshot shows the D-Link web interface for the DCS-5000L camera. The main navigation bar includes 'LIVE VIDEO', 'SETUP', 'MAINTENANCE', 'STATUS', and 'HELP'. The 'SETUP' menu is expanded to show 'Time and Date' as the selected option. The interface is divided into three main sections:

- TIME AND DATE:** This section provides an overview of the time configuration options. It includes a 'Save Settings' button and a 'Don't Save Settings' button.
- TIME CONFIGURATION:** This section displays the current time as '01 Jan 2015 12:14:18 A.M.' and the selected time zone as '(GMT-12:00) International Date Line West'.
- AUTOMATIC TIME CONFIGURATION:** This section allows for automatic synchronization with an NTP server. It includes a checkbox for 'Synchronize NTP Server', a dropdown for 'NTP Server Used', and radio buttons for 'Enable' and 'Disable'. It also features an 'Offset' dropdown set to '+1:00' and a table for daylight saving settings:
 

	Month	Week	Day of Week	Time
Start	Jan	1st	Sun	12 am
End	Jan	1st	Sun	12 am
- SET THE DATE AND TIME MANUALLY:** This section provides manual input fields for Year (2015), Month (1), Day (1), Hour (0), Minute (14), and Second (12). It includes a 'Copy Your Computer's Time Settings' button and 'Save Settings' and 'Don't Save Settings' buttons.

Helpful Hints on the right side of the page provide additional information:
 

- Time Zone:** The geographical zone for the local time setting.
- Automatic Time Configuration:** With this option selected, the camera will synchronize its date and time settings with an NTP server over the Internet upon camera start up. If the timeserver cannot be reached, no time settings will be applied.
- NTP Server:** The IP address or domain name of the Time Server.
- Daylight Saving:** Enable daylight saving that will adjust the time depending on the daylight saving time, offset and date.
- You may also Set the Date and Time Manually or Copy your Computer's Time Settings.**

# Day/Night Mode

This section allows you to configure when Day and Night modes are used. Day mode uses the infrared cut filter to provide a corrected color image for times where there is available lighting. Night mode moves the filter out of the way to use all available light, and turns on the IR LED illuminators to allow for clear black and white video in dark areas with little or no light.

**Auto:** This mode will automatically switch between Day and Night mode based on the amount of available lighting.

**Manual:** This mode allows you to manually switch between modes through the **Live Video** page.

**Always Day Mode:** This sets the camera to always use Day mode.

**Always Night Mode:** This sets the camera to always use Night mode.

**Day Mode Schedule:** This sets the camera to use Day mode during the times you specify, and will switch to Night mode outside the times you specify.

**D-Link**

DCS-5000L // LIVE VIDEO SETUP MAINTENANCE STATUS HELP

**DAY/NIGHT MODE**

In this section, you can configure the Day/Night mode switching method. Day/Night mode ensures good video illumination in both day and night environments.

In Day mode, IR illumination is off, IR light is blocked and the video is in color. In Night mode, IR illumination is on, IR light is visible and the video is in black & white.

Save Settings Don't Save Settings

**DAY/NIGHT MODE SETTINGS**

Day/Night Mode  Auto  
Light Sensor Sensitivity Medium

Manual

Always Day Mode

Always Night Mode

Day Mode Schedule

Mon	: 00:00	~	00:00	(Example : 08:00 ~ 18:30)
Tue	: 00:00	~	00:00	(Example : 08:00 ~ 18:30)
Wed	: 00:00	~	00:00	(Example : 08:00 ~ 18:30)
Thu	: 00:00	~	00:00	(Example : 08:00 ~ 18:30)
Fri	: 00:00	~	00:00	(Example : 08:00 ~ 18:30)
Sat	: 00:00	~	00:00	(Example : 00:00 ~ 00:00)
Sun	: 00:00	~	00:00	(Example : 00:00 ~ 24:00)

Save Settings Don't Save Settings

**Helpful Hints...**

**Auto** - Camera automatically switches between Day and Night mode. The camera normally works in Day mode. It automatically changes to Night mode in darker lighting.

**Manual** - User can manually control the camera to work in Day or Night mode on the live video view page.

**Always Day Mode** - The camera always works in the Day mode.

**Always Night Mode** - The camera always works in the Night mode.

**Day Mode Schedule** - The camera works in Day mode based on the day and time configured in the schedule. The camera changes to Night mode during all other times. The example displayed on the right side of the Mon/Tue/Wed/Thu/Fri/Sat/Sun fields mean that the camera works in Day mode from 08:00 to 18:30 on Monday, Tuesday, Wednesday, Thursday and Friday, works in Night mode for all of Saturday, and works in Day mode for all of Sunday.

**SURVEILLANCE**

# Camera Control

This section allows you to configure the pan and tilt operations of your camera. You can specify the lens location for the **Home** button, and specify up to 24 pre-set lens locations, allowing you to quickly view these pre-determined areas of the camera's range from the **Live Video** screen.

**Pan/Tilt Wheel:** Use the directional arrows on the wheel to move the camera lens through its pan and tilt ranges.

**Set as Home:** Click this button to set the current lens location as the **Home** location. Once set, the camera will return to this location whenever the Home button in the center of the pan/tilt wheel is clicked.

**Default Home:** Clicking on this button returns the **Home** location to the factory default setting.

**Pan Step:** Select the increment of movement for each press of a pan (up/down) arrow on the pan/tilt wheel.

**Tilt Step:** Select the increment of movement for each press of a tilt (left/right) arrow on the pan/tilt wheel.

**Preset Position:** The camera allows you to specify up to 24 pre-determined lens positions, which can be used to quickly move the camera's view to areas of interest.

- Select the number of the position that you would like to specify.
- Use the pan/tilt wheel to move the camera's lens to the desired preset position.

**D-Link**

DCS-5000L // LIVE VIDEO SETUP MAINTENANCE STATUS HELP

Wizard  
Network Setup  
Wireless Setup  
Dynamic DNS  
Image Setup  
Video  
Audio  
Motion Detection  
Sound Detection  
Mail  
FTP  
Time and Date  
Day/Night Mode  
Camera Control  
Logout

**CAMERA CONTROL**

In this section, you can set or clear the camera preset positions.

Please note that your computer needs to have Java installed in order to view the video window. If you do not see the live video below, please visit <http://www.java.com> to download and install Java.

**PRESET POSITION SETTING**

Home Definition  
Set As Home  
Default Home

Pan Step 5  
Tilt Step 5

Preset Position 1 Clear  
Preset Name Set

**Helpful hints...**

**Pan Tilt Control:** You can control the camera lens position by clicking the Up/Down/Left/Right/Left-up/Left-down/Right-up/Right-down arrow buttons. Clicking the Home button will move the lens to the original home position.

**Home Definition:** Allow you to set a new Home position or default back to the original position.

**Pan Step:** This is used to control the step at which the camera is moved using the Pan feature.

**Tilt Step:** This is used to control the step at which the camera is moved using the Tilt feature.

**Set Preset Position:** Move the camera to a desired position, select a Preset Position and input Preset Name, and then clicking Set will set current position to the selected preset position.

**Clear Preset Position:** Clear a selected Preset Position.

**SURVEILLANCE**



- Enter a Preset Name to help you easily identify the preset.
- Click on the Set button to save the preset.
- Any pre-saved positions can be cleared by selecting the desired preset and clicking on the **Clear** button.

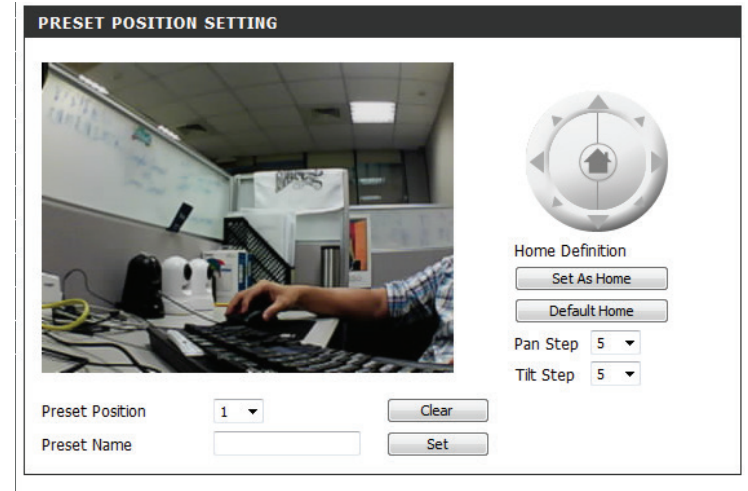

# Maintenance Admin

This section allows you to change the administrator's password and configure the server settings for your camera. You can also manage the user account(s) that are allowed to access to your camera.

**Admin Password:** To change the admin password used to log into the web interface, enter the old password, then enter the new password and retype it in the next text box, then click **Apply**.

**Camera Name:** Specify a name for your camera.

**LED Control:** Select **Normal** to enable the LEDs on the front of the device, or select **Off** to disable the LED. Disabling the LED function may be useful if you want to make the camera less obvious.

**User Access Control:** Select **Enable** to enable user access control or **Disable** to allow only the administrator account to access the camera.

**Snapshot URL Authentication:** Select **Enable** to allow access to the current camera snapshot via the web address indicated.

**Add User Account:** You can create new users to provide viewing access for your camera's video. User accounts will only be able to access the **Live Video** section of the web configuration interface, but cannot access any other parts or change any settings.

To create a new user, enter a user name, password, and retype the password, then click **Add**. A maximum of 8 user accounts can be created.

The screenshot displays the D-Link web interface for the DCS-5000L camera. The top navigation bar includes 'LIVE VIDEO', 'SETUP', 'MAINTENANCE', 'STATUS', and 'HELP'. The 'MAINTENANCE' section is active, showing the 'ADMIN' configuration page. On the left, a sidebar menu lists 'Admin', 'System', 'Firmware Upgrade', and 'Logout'. The main content area is titled 'ADMIN' and contains several sections: 'ADMIN PASSWORD SETTING' with input fields for 'Old Password', 'New Password', and 'Retype Password'; 'SERVER SETTING' with fields for 'Camera Name' (DCS-5000L), 'LED Control' (Normal/Off), 'User Access Control' (Enable/Disable), and 'Snapshot URL Authentication' (Enable/Disable); 'ADD USER ACCOUNT' with fields for 'User Name', 'Password', and 'Retype Password'; and 'USER LIST' with a table containing columns for 'no.', 'name', 'modify', and 'delete'. A 'Helpful Hints' sidebar on the right provides security advice regarding password changes.

**User List:** Displays the account names of authorized users. You can modify or delete an account by clicking on its modify or delete icon.

**ADMIN PASSWORD SETTING**

Old Password

New Password

Retype Password

---

**SERVER SETTING**

Camera Name

LED Control  Normal  Off

User Access Control  Enable  Disable

Snapshot URL Authentication  Enable  Disable (<http://192.168.0.147/image/jpeg.cgi>)

---

**ADD USER ACCOUNT**

User Name

Password

Retype Password

---

**USER LIST**

no.	name	modify	delete

# System

This section allows you to save and restore your configuration, restore the factory settings, and/or restart the camera.

**Save To Local Hard Drive:** Click the **Save Configuration** button to save the current camera configuration to your local PC.

**Load From Local Hard Drive:** To load a previously saved configuration, click the **Browse...** button, select your saved configuration file, then click the **Restore Configuration From File** button.

**Restore To Factory Default:** Click the **Restore Factory Defaults** button to reset all settings back to the factory defaults. Please note that this will erase any changes you have made to the settings of the camera.

**Reboot The Device:** Click the **Reboot the Device** button to reboot the camera.

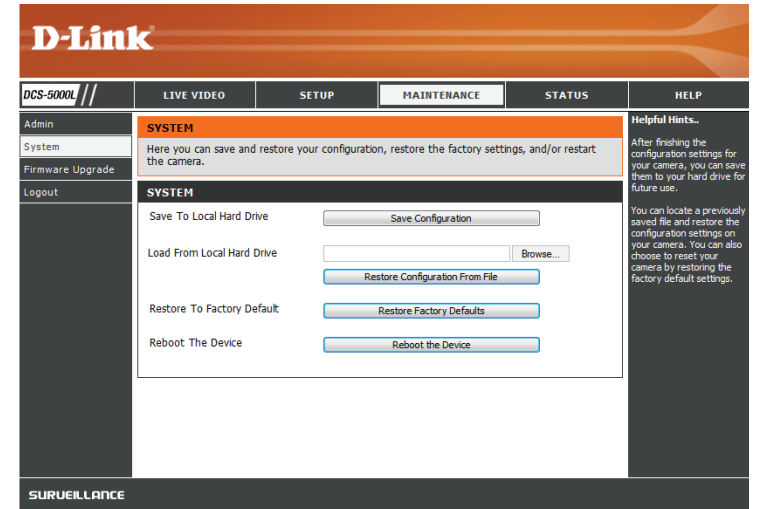

# Firmware Upgrade

Your current firmware version and date will be displayed on your screen. You may go to the D-Link Support Page to check for the latest firmware versions available.

To upgrade the firmware on your DCS-5000L, download the latest firmware from the D-Link Support Page to your local hard drive. Click the **Browse...** button and select the firmware file, then click the **Upload** button to start the firmware upgrade.

**Warning:** The firmware upgrade process must not be interrupted or the camera may be damaged. When upgrading firmware, do not unplug the camera or your PC, or close your web browser until the process is complete. It is also highly recommended that you use a wired connection for your camera and PC when upgrading firmware.

The screenshot displays the D-Link web interface for the DCS-5000L camera. The top navigation bar includes 'LIVE VIDEO', 'SETUP', 'MAINTENANCE', 'STATUS', and 'HELP'. The 'MAINTENANCE' tab is active. The main content area is titled 'FIRMWARE UPGRADE' and contains the following text:

A new firmware upgrade may be available for your camera. It is recommended that you keep your camera firmware up to date to maintain and improve its functionality and performance. Click here [D-Link Support Page](#) to check for the latest available firmware version.

To upgrade the firmware on your IP camera, please download and save the latest firmware version from the D-Link Support Page to your local hard drive. Locate the file on your local hard drive by clicking the Browse button. Once you have found and opened the file using the browse button, click the Upload button to start the firmware upgrade.

**FIRMWARE INFORMATION**

Current Firmware Version :	1.00.07
Current Firmware Date :	2015-02-06
Current Agent Version :	2.0.18-b61

**FIRMWARE UPGRADE**

File Path :

Helpful Hints...  
Firmware updates are released periodically to improve the functionality of your IP camera and also to add new features. If you run into a problem with a specific feature of the IP camera, check our support site by clicking [here](#) and see if updated firmware is available for your IP camera.

DCS-5000L // SURVEILLANCE

# Status

## Device Info

This section displays all the detailed information about your device and network settings.

The screenshot shows the D-Link web interface for a DCS-5000L camera. The top navigation bar includes 'DCS-5000L //', 'LIVE VIDEO', 'SETUP', 'MAINTENANCE', 'STATUS', and 'HELP'. The 'STATUS' tab is selected, and the 'DEVICE INFO' sub-tab is active. The main content area is divided into two sections: 'BASIC INFORMATION' and 'WIRELESS STATUS'. A 'Refresh' button is located at the bottom of the wireless status section. On the right side, there is a 'Helpful Hints..' section with a warning icon and text.

DCS-5000L //		LIVE VIDEO	SETUP	MAINTENANCE	STATUS	HELP	
Device Info	<b>DEVICE INFO</b>				Helpful Hints..		
Active User	All of your network connection details are displayed on this page. The firmware version is also displayed here.				All of your network connection details are displayed on this page.		
Logout							
		<b>BASIC INFORMATION</b>					
		Camera Name DCS-5000L Time & Date 01 Jan 2015 12:16:09 A.M. Firmware Version 1.00.07 (2015-02-06) Agent Version 2.0.18-b61 MAC Address B0 C5 54 1B 48 73 IP Address 192.168.0.147 Subnet Mask 255.255.255.0 Default Gateway 192.168.0.1 Primary DNS 192.168.0.1 Secondary DNS 0.0.0.0 DDNS Disable UPnP Port Forwarding Disable  FTP Server Test No test conducted. E-mail Test No test conducted.					
		<b>WIRELESS STATUS</b>					
		Connection Mode Infrastructure Link No SSID dlink (MAC : 00 00 00 00 00 00) Channel 6 Encryption WPA2-PSK:AE5					
		<input type="button" value="Refresh"/>					
<b>SURVEILLANCE</b>							

# Active User

This page lists all the active users' information including the User Name, IP address, and the time that camera access began.

**D-Link**

DCS-5000L // LIVE VIDEO SETUP MAINTENANCE STATUS HELP

Device Info

Active User

Logout

**ACTIVE USER**

This page lists active user information, including user name, IP address and the initial access time.

**USER LIST**

no.	user name	IP address	time
-----	-----------	------------	------

Refresh

**Helpful Hints..**

All of the active users are listed on this page. The time information indicates the time that each user started accessing the camera.

**SURUEILLANCE**

# Help

This page lists all the topics and links to respective helpful instructions for each feature.

DCS-5000L //		LIVE VIDEO	SETUP	MAINTENANCE	STATUS	HELP
Menu	<b>SUPPORT MENU</b>					
Live Video	<ul style="list-style-type: none"> <li>• Live Video</li> <li>• Setup</li> <li>• Maintenance</li> <li>• Status</li> </ul>					
Setup						
Maintenance						
Status	<b>LIVE VIDEO</b>					
Logout	<ul style="list-style-type: none"> <li>• <a href="#">Camera</a></li> </ul>					
	<b>SETUP</b>					
	<ul style="list-style-type: none"> <li>• <a href="#">Wizard</a></li> <li>• <a href="#">Network Setup</a></li> <li>• <a href="#">Wireless Setup</a></li> <li>• <a href="#">Dynamic DNS</a></li> <li>• <a href="#">Image Setup</a></li> <li>• <a href="#">Video</a></li> <li>• <a href="#">Audio</a></li> <li>• <a href="#">Motion Detection</a></li> <li>• <a href="#">Sound Detection</a></li> <li>• <a href="#">Mail</a></li> <li>• <a href="#">FTP</a></li> <li>• <a href="#">Time and Date</a></li> <li>• <a href="#">Day/Night Mode</a></li> <li>• <a href="#">Camera Control</a></li> </ul>					
	<b>MAINTENANCE</b>					
	<ul style="list-style-type: none"> <li>• <a href="#">Admin</a></li> <li>• <a href="#">System</a></li> <li>• <a href="#">Firmware Upgrade</a></li> </ul>					
	<b>STATUS</b>					
	<ul style="list-style-type: none"> <li>• <a href="#">Device Info</a></li> <li>• <a href="#">Active User</a></li> </ul>					
<b>SURVEILLANCE</b>						



# Troubleshooting

## 1. What is Remote Access? How do I enable it?

Remote Access allows you to access your camera from any PC connected to the Internet through a web browser. This lets you view your camera feed and manage your camera's settings when you're away from home.

To enable Remote Access, simply go through the Camera Installation Wizard. You can also download the wizard from: **<http://www.mydlink.com/support>**

After going through the wizard, you should see "Remote Status: Enabled" on the summary page.

If you see Remote Status: Disabled, make sure that:

- the front LED on your camera is lit solid green
- your Internet connection is working
- your router's LAN & WAN connections are working properly
- your router has UPnP enabled (if your router does not support UPnP, please refer to Appendix A)
- your router can get a public IP address
- your router's firmware has been upgraded to the latest version
- you have tried rebooting your router by unplugging it, then plugging it back in

After checking the above items, you can click the **Retry** button to refresh the summary screen to see if Remote Access has been enabled.

## 2. What can I do if I forget the password for my camera's web configuration interface?

If you forget your password, you will need to perform a factory reset of your camera. This process will change all your settings back to the factory defaults. It is therefore recommended that you make a record of the password for future reference.

To reset your camera, please use an unfolded paperclip to press and hold the RESET button for at least 10 seconds while your camera is plugged in.

### **3. The image on the live view is blurry or out of focus, what can I do?**

You can manually adjust the focus of the lens by rotating the bezel on the front of the camera (surrounding the lens). While watching the live view, rotate the bezel until the desired level of focus is achieved.

### **4. Why don't the LEDs light up?**

The power supply might be faulty. Confirm that you are using the provided DC 12 V power supply for this network camera. Verify that the power supply is correctly connected. The WPS LED will only turn on if there is a WPS connection present, the camera may still be functioning correctly even if this LED is not lit. If the camera is functioning normally, the LEDs may have been disabled. See **Admin** on page 50 for information about how to enable the LEDs.

### **5. Why is the camera's network connection unreliable?**

There might be a problem with the network cable. To confirm that the cables are working, PING the address of a known device on the network. If the cabling is OK and your network is reachable, you should receive a reply similar to the following (...bytes = 32 time = 2 ms).

Another possible problem may be that the network device such as a hub or switch utilized by the Network Camera is not functioning properly. Please confirm the power for the devices are well connected and functioning properly.

If you are using a wireless connection to connect the camera, be aware of the range limitations of the wireless N standard. Most wireless N devices have a maximum indoor range of around 70 metres (230 feet). Also be aware that obstacles such as walls, floors, doors and other solid objects can have an adverse effect on signal range.

### **6. Why does a series of broad vertical white lines appear through out the image?**

It could be that the image sensor has become overloaded when it has been exposed to bright light such as direct exposure to sunlight or halogen lights. Reposition the camera into a more shaded area immediately, as prolonged exposure to bright lights will damage the sensor.

### **7. The camera is producing noisy images. How can I solve the problem?**

The video images might be noisy if the camera is used in a very low light environment. Try switching to night mode if you are consistently monitoring a low light area.

### **8. The images are poor quality, how can I improve the image quality?**

Make sure that your computer's display properties are set to at least 6-bit color. Using 16 or 256 colors on your computer will produce dithering artifacts in the image, making the image look as if it is of poor quality.

You may also need to check your image settings to make sure the brightness, contrast, and other settings are set properly. For more, refer to **Image Setup** on page 36.

### **9. Why are no images available through the Web browser?**

ActiveX might be disabled. If you are viewing the images from Internet Explorer make sure ActiveX has been enabled in the Internet Options menu. You may also need to change the security settings on your browser to allow the ActiveX plug-in to be installed. Also, check that you have the latest version of Java installed. Java can be downloaded from <http://www.java.com>

If you are using Internet Explorer with a version number 6 or lower, then you will need to upgrade your Web browser software in order to view the streaming video transmitted by the Network Camera.

# Technical Specifications

## System Requirements

- Microsoft Windows® 10<sup>1</sup>/8/7/Vista/XP, or Mac with OS X
- PC with 1.3 GHz or above and at least 128 MB RAM
- Internet Explorer 7, Firefox 12, Safari 6, or Chrome 20<sup>2</sup> or higher version with Java installed and enabled

## Networking Protocol

- IPV4, ARP, TCP, UDP, ICMP
- DHCP Client
- NTP Client (D-Link)
- DNS Client
- DDNS Client (D-Link)
- SMTP Client
- FTP Client
- HTTP Server
- PPPoE
- UPnP Port Forwarding
- LLTD

## Built-In Protocol

- 10/100 BASE-TX Fast Ethernet
- 802.11n/g/b WLAN

## Wireless Connectivity

- 802.11n/g/b Wireless with WEP/WPA/WPA2 security
- WPS

## Wireless Transmit Output Power (typical)

- 802.11b - 16 dbm
- 802.11g/802.11n - 12 dbm

## Reset Button

- Reset to factory default

## Video Codecs

- MJPEG
- JPEG for still images

## Video Features

- Adjustable image size and quality
- Time stamp and text overlay
- Flip and Mirror

## Resolution

- 640 x 480 at up to 20 fps
- 320 x 240 at up to 30 fps
- 160 x 112 at up to 30 fps

## Lens

- Focal length: 2.2 mm, F2.4

## Sensor

- VGA 1/5 inch CMOS sensor

## IR LED

- 8 meter illumination distance with light sensor

<sup>1</sup> Edge browser is not supported

<sup>2</sup> mylink Portal only

### **Minimum Illumination**

- Color: 1 lux @ F2.4 (Day)
- B/W: 0 lux @ F2.4 (Night)

### **Viewing Angle**

- Horizontal: 57°
- Vertical: 42°
- Diagonal: 68°

### **Pan/tilt range**

- Pan Range: +170° ~ -170° (Total 340°)
- Tilt Range: +95° ~ -25° (Total 120°)

### **Digital Zoom**

- Up to 4x

### **3A Control**

- AGC (Auto Gain Control)
- AWB (Auto White Balance)
- AES (Auto Electronic Shutter)

### **Power**

- Input: 100-240 V AC, 50/60 Hz
- Output: 5 V DC, 1.5 A

### **Dimensions (W x D x H)**

- Camera Only - 116.4 x 109.1 x 133.6 mm (4.58 x 4.30 x 5.26 inches)
- Camera Including Mounting Bracket - 116.4 x 109.1 x 230.0 mm (4.58 x 4.30 x 9.06 inches)

### **Weight**

- Device: 292.8 grams (0.65 lbs)
- Mounting Bracket: 60.8 grams (0.13 lbs)

### **Max Power Consumption**

- 4.8 W

### **Operation Temperature**

- 0 °C to 40 °C (32 °F to 104 °F)

### **Storage Temperature**

- -25 °C to 70 °C (-13 °F to 158 °F)

### **Humidity**

- 20-85% RH non-condensing

### **Emission (EMI), Safety & Other Certifications**

- FCC
- CE
- C-Tick
- CE LVD

# Regulatory Statements

## **Federal Communication Commission Interference Statement**

This equipment has been tested and found to comply with the limits for a Class B digital device, pursuant to Part 15 of the FCC Rules. These limits are designed to provide reasonable protection against harmful interference in a residential installation. This equipment generates, uses and can radiate radio frequency energy and, if not installed and used in accordance with the instructions, may cause harmful interference to radio communications. However, there is no guarantee that interference will not occur in a particular installation. If this equipment does cause harmful interference to radio or television reception, which can be determined by turning the equipment off and on, the user is encouraged to try to correct the interference by one of the following measures:

- Reorient or relocate the receiving antenna.
- Increase the separation between the equipment and receiver.
- Connect the equipment into an outlet on a circuit different from that to which the receiver is connected.
- Consult the dealer or an experienced radio/TV technician for help.

## **Non-modifications Statement:**

Any changes or modifications not expressly approved by the party responsible for compliance could void the user's authority to operate this equipment.

## **Caution:**

This device complies with Part 15 of the FCC Rules. Operation is subject to the following two conditions:

- (1) This device may not cause harmful interference, and
- (2) this device must accept any interference received, including interference that may cause undesired operation.

This device and its antenna(s) must not be co-located or operating in conjunction with any other antenna or transmitter except in accordance with FCC multi-transmitter product procedures. For product available in the USA/Canada market, only channel 1~11 can be operated. Selection of other channels is not possible.

## **Note**

The country code selection is for non-USA models only and is not available to all USA models. Per FCC regulations, all WiFi product marketed in the USA must be fixed to USA operational channels only.

## **RF Frequency Requirements**

This device is for indoor use only when using all channels in the x.xxx to x.xxx GHz frequency range. High power radars are allocated as primary users of the x.xxx to x.xxx GHz bands. These radar stations can cause interference with and/or damage this device.

It is restricted to indoor environments only.

## **IMPORTANT NOTICE:**

### **FCC Radiation Exposure Statement**

This equipment complies with FCC radiation exposure limits set forth for an uncontrolled environment. This equipment should be installed and operated with minimum distance 20 cm between the radiator and your body.

### **Industry Canada Statement:**

This device complies with Industry Canada licence-exempt RSS standard(s). Operation is subject to the following two conditions:

- (1) this device may not cause interference, and
- (2) this device must accept any interference, including interference that may cause undesired operation of the device.

Le présent appareil est conforme aux CNR d'Industrie Canada applicables aux appareils radio exempts de licence. L'exploitation est autorisée aux deux conditions suivantes:

- (1) l'appareil ne doit pas produire de brouillage, et
- (2) l'utilisateur de l'appareil doit accepter tout brouillage radioélectrique subi, même si le brouillage est susceptible d'en compromettre le fonctionnement.

(ii) for devices with detachable antenna(s), the maximum antenna gain permitted for devices in the bands 5250-5350 MHz and 5470-5725 MHz shall be such that the equipment still complies with the e.i.r.p. limit;

(ii) pour les dispositifs munis d'antennes amovibles, le gain maximal d'antenne permis pour les dispositifs utilisant les bandes de 5250 à 5350MHz et de 5470 à 5725 MHz doit être conforme à la limite de la p.i.r.e;

## **NCC 警語：**

### **以下警語適用台灣地區**

經型式認證合格之低功率射頻電機，非經許可，公司、商號或使用者均不得擅自變更頻率、加大功率或變更原設計之特性及功能。低功率射頻電機之使用不得影響飛航安全及干擾合法通信；經發現有干擾現象時，應立即停用，並改善至無干擾時方得繼續使用。前項合法通信，指依電信法規定作業之無線電通信。低功率射頻電機須忍受合法通信或工業、科學及醫療用電波輻射性電機設備之干擾。

### **無線傳輸設備 (UNII)**

在 5.25-5.35 赫茲頻帶內操作之無線資訊傳輸設備，限於室內使用。無線資訊傳輸設備忍受合法通信之干擾且不得干擾合法通信；如造成干擾，應立即停用，俟無干擾之虞，始得繼續使用。無線資訊傳輸設備的製造廠商應確保頻率穩定性，如依製造廠商使用手冊上所述正常操作，發射的信號應維持於操作頻帶中。

電磁波曝露量MPE標準值(MPE) 1 mW/cm<sup>2</sup>，送測產品實值為 0 mW/cm<sup>2</sup>



## **European Union:**

This device complies with the essential requirements of the R&TTE Directive 1999/5/EC. For more information, please refer to the Declaration of Conformity.

## **Notice of Wireless Radio LAN Usage in The European Community:**

- At the time of writing this addendum, some countries such as Italy, Greece, Portugal, and Spain have not allowed operation of radio devices in the 5 GHz bands, although operation of 2.4 GHz radio devices is allowed. Please check with your local authority to confirm.
- This device is restricted to indoor use when operated in the European Community using channels in the 5.15-5.35 GHz band to reduce the potential for interference.
- This device is a 2.4 GHz wideband transmission system (transceiver), intended for use in all EU member states and EFTA countries, except in France where restrictive use applies. This device may not be used for setting up outdoor radio links in France and in some areas the RF output power may be limited to 10 mW EIRP in the frequency range of 2454 –2483.5 MHz. For detailed information the end-user should contact the national spectrum authority in France.

This equipment may be operated in AL, AD, BE, BG, DK, DE, FI, FR, GR, GW, IS, IT, HR, LI, LU, MT, MK, MD, MC, NL, NO, AT, OL, PT, RO, SM, SE, RS, SK, ES, CI, HU, CY

## **Usage Notes:**

- To remain in conformance with European National spectrum usage regulations, frequency and channel limitations will be applied on the products according to the country where the equipment will be deployed.
- This device is restricted from functioning in Ad-hoc mode while operating in 5 GHz. Ad-hoc mode is direct peer-to-peer communication between two client devices without an Access Point.
- Access points will support DFS (Dynamic Frequency Selection) and TPC (Transmit Power Control) functionality as required when operating in 5 GHz within the EU.

**2.4 GHz Wireless Frequency and Channel Operation in EEC Countries:**

Region	Frequency Band	Max output power (EIRP)
Metropolitan	2400 - 2454 MHz	100 mW
Guadeloupe, Martinique, St Pierre et Miquelon, Mayotte	2454 - 2483.5 MHz	100 mW indoor, 10 mW outdoor
Reunion et Guyane	2400 - 2483.5 MHz	100 mW
Rest of EU community	2420 - 2483.5 MHz	100 mW

R&TTE 1999/5/EC			
WLAN 2.4 - 2.4835 GHz			
IEEE 802.11b/g/n			
Spectrum Regulation	MHz, Europa (ETSI)	max. EIRP Innenbereich	max. EIRP Außenbereich
Europa	2400 - 2483.5 MHz	100 mW	100 mW
Frankreich	2400 - 2454 MHz	100 mW	100 mW
	2454 - 2483.5 MHz	100 mW	10 mW

## European Community Declaration of Conformity:

Česky [Czech]	D-Link tímto prohlašuje, že tento <###> je ve shodě se základními požadavky a dalšími příslušnými ustanoveními směrnice 1999/5/ES.
Dansk [Danish]	Undertegnede D-Link erklærer herved, at følgende udstyr <###> overholder de væsentlige krav og øvrige relevante krav i direktiv 1999/5/EF.
Deutsch [German]	Hiermit erkläre D-Link, dass sich das Gerät <###> in Übereinstimmung mit den grundlegenden Anforderungen und den übrigen einschlägigen Bestimmungen der Richtlinie 1999/5/EG befindet.
Eesti [Estonian]	Käesolevaga kinnitab D-Link seadme <###> vastavust direktiivi 1999/5/EÜ põhinõuetele ja nimetatud direktiivist tulenevatele teistele asjakohastele sätetele.
English	D-Link hereby, declares that this <###> is in compliance with the essential requirements and other relevant provisions of Directive 1999/5/EC.
Español [Spanish]	Por medio de la presente D-Link declara que el <###> cumple con los requisitos esenciales y cualesquiera otras disposiciones aplicables o exigibles de la Directiva 1999/5/CE.
Ελληνική [Greek]	ΜΕ ΤΗΝ ΠΑΡΟΥΣΑ D-Link ΔΗΛΩΝΕΙ ΟΤΙ <###> ΣΥΜΜΟΡΦΩΝΕΤΑΙ ΠΡΟΣ ΤΙΣ ΟΥΣΙΩΔΕΙΣ ΑΠΑΙΤΗΣΕΙΣ ΚΑΙ ΤΙΣ ΛΟΙΠΕΣ ΣΧΕΤΙΚΕΣ ΔΙΑΤΑΞΕΙΣ ΤΗΣ ΟΔΗΓΙΑΣ 1999/5/ΕΚ.
Français [French]	Par la présente D-Link déclare que l'appareil <###> est conforme aux exigences essentielles et aux autres dispositions pertinentes de la directive 1999/5/CE.
Italiano [Italian]	Con la presente D-Link dichiara che questo <###> è conforme ai requisiti essenziali ed alle altre disposizioni pertinenti stabilite dalla direttiva 1999/5/CE.
Latviski [Latvian]	Ar šo D-Link deklarē, ka <###> atbilst Direktīvas 1999/5/EK būtiskajām prasībām un citiem ar to saistītajiem noteikumiem.
Lietuvių [Lithuanian]	Šiuo D-Link deklaruoja, kad šis <###> atitinka esminius reikalavimus ir kitas 1999/5/EB Direktyvos nuostatas.
Nederlands [Dutch]	Hierbij verklaart D-Link dat het toestel <###> in overeenstemming is met de essentiële eisen en de andere relevante bepalingen van richtlijn 1999/5/EG.
Malti [Maltese]	Hawnhekk, D-Link, jiddikjara li dan <###> jikkonforma mal-ħtiġijiet essenzjali u ma provvedimenti oħrajn relevanti li hemm fid-Dirrettiva 1999/5/EC.
Magyar [Hungarian]	Alulírott, D-Link nyilatkozom, hogy a <###> megfelel a vonatkozó alapvető követelményeknek és az 1999/5/EC irányelv egyéb előírásainak.

Polski [Polish]	Niniejszym D-Link oświadcza, że <###> jest zgodny z zasadniczymi wymogami oraz pozostałymi stosownymi postanowieniami Dyrektywy 1999/5/EC.
Português [Portuguese]	D-Link declara que este <###> está conforme com os requisitos essenciais e outras disposições da Directiva 1999/5/CE.
Slovensko [Slovenian]	D-Link izjavlja, da je ta <###> v skladu z bistvenimi zahtevami in ostalimi relevantnimi določili direktive 1999/5/ES.
Slovensky [Slovak]	D-Link týmto vyhlasuje, že <###> spĺňa základné požiadavky a všetky príslušné ustanovenia Smernice 1999/5/ES.
Suomi [Finnish]	D-Link vakuuttaa täten että <###> tyyppinen laite on direktiivin 1999/5/EY oleellisten vaatimusten ja sitä koskevien direktiivin muiden ehtojen mukainen.

**Warning Statement:**

The power outlet should be near the device and easily accessible.



## Safety Instructions

Please adhere to the following safety guidelines to help ensure your own personal safety and protect your system from potential damage. Any acts taken that are inconsistent with ordinary use of the product, including improper testing, etc., and those not expressly approved by D-Link may result in the loss of product warranty.

Unless expressly approved by an authorized representative of D-Link in writing, you may not and may not permit others to:

- Disassemble or reverse engineer the device or attempt to derive source code (underlying ideas, algorithms, or structure) from the device or from any other information provided by D-Link, except to the extent that this restriction is expressly prohibited by local law.
- Modify or alter the device.
- Remove from the device any product identification or other notices, including copyright notices and patent markings, if any.

To reduce the risk of bodily injury, electrical shock, fire, and damage to the device and other equipment, observe the following precautions:

### Power Sources

- Observe and follow service markings.
- Do not push any objects into the openings of your device unless consistent with the authorized operation of the device. Doing so can cause a fire or an electrical shock by shorting out interior components.
- The powering of this device must adhere to the power specifications indicated for this product.
- Do not overload wall outlets and/or extension cords as this will increase the risk of fire or electrical shock.
- Do not rest anything on the power cord or on the device (unless the device is made and expressly approved as suitable for stacking).
- Position system cables and power cables carefully; route cables so that they cannot be stepped on or tripped over. Be sure that nothing rests on any cables.
- Operate the device only from the type of external power source indicated on the electrical ratings label.
- To help avoid damaging your device, be sure the voltage selection switch (if provided) on the power supply is set to match the power available at your location.
- Also be sure that attached devices are electrically rated to operate with the power available in your location.

- Use only approved power cable(s). If you have not been provided a power cable for your device or for any AC -powered option intended for your device, purchase a power cable that is approved for use in your country and is suitable for use with your device. The power cable must be rated for the device and for the voltage and current marked on the device's electrical ratings label. The voltage and current rating of the cable should be greater than the ratings marked on the device.
- To help prevent an electrical shock, plug the device and peripheral power cables into properly grounded electrical outlets. These cables are equipped with three-prong plugs to help ensure proper grounding. Do not use adapter plugs or remove the grounding prong from a cable. If you must use an extension cable, use a 3-wire cable with properly grounded plugs.
- Observe extension cable and power strip ratings. Ensure that the total ampere rating of all products plugged into the extension cable or power strip does not exceed 80 percent of the ampere ratings limit for the extension cable or power strip.
- To help protect your device from sudden, transient increases and decreases in electrical power, use a surge suppressor, line conditioner, or uninterruptible power supply (UPS).
- Do not modify power cables or plugs. Consult a licensed electrician or your power company for site modifications. Always follow your local/national wiring rules.
- When connecting or disconnecting power to hot-pluggable power supplies, if offered with your device, observe the following guidelines.
- Install the power supply before connecting the power cable to the power supply.
- Unplug the power cable before removing the power supply.
- If the system has multiple sources of power, disconnect power from the device by unplugging all power cables from the power supplies.

### **Servicing/Disassembling**

- Do not service any product except as expressly set forth in your system documentation.
- Opening or removing covers that are marked with the triangular symbol with a lightning bolt may expose you to an electrical shock. Only a trained service technician should service components inside these compartments.
- To reduce the risk of electrical shock, never disassemble this device. None of its internal parts are user-replaceable; therefore, there is no reason to access the interior.
- Do not spill food or liquids on your system components, and never operate the device in a wet environment. If the device gets wet, see the appropriate section in your troubleshooting guide or contact your trained service provider.
- Use the device only with approved equipment.

- Move products with care; ensure that all casters and/or stabilizers are firmly connected to the system. Avoid sudden stops and uneven surfaces.

### **Environment**

- Do not use this device near water (e.g. near a bathtub, sink, laundry tub, fish tank, in a wet basement or near a swimming pool).
- Do not use this device in areas with high humidity.
- This device must not be subjected to water or condensation.
- Keep your device away from radiators and heat sources. Also, do not block cooling vents.

### **Cleaning**

- Always unplug the power before cleaning this device.
- Do not use liquid or aerosol cleaners of any kind. Use only compressed air that is recommended for electronic devices.
- Use a dry cloth for cleaning.

### **Protecting Against Electrostatic Discharge**

Static electricity can harm delicate components inside your system. To prevent static damage, discharge static electricity from your body before you touch any of the electronic components, such as the microprocessor. You can do so by periodically touching an unpainted metal surface on the chassis.

You can also take the following steps to help prevent damage from electrostatic discharge (ESD):

1. When unpacking a static-sensitive component from its shipping carton, do not remove the component from the antistatic packing material until you are ready to install the component in your system. Just before unwrapping the antistatic packaging, be sure to discharge static electricity from your body.
2. When transporting a sensitive component, first place it in an antistatic container or packaging.
3. Handle all sensitive components in a static-safe area. If possible, use antistatic floor pads, workbench pads, and an antistatic grounding strap.

### **Environmental**

This product may contain a battery. Recycle or dispose of batteries in accordance with the battery manufacturer's instructions and local/national disposal and recycling regulations. For more information, please refer to the warranty guide.

## Disposing of and Recycling Your Product



EN

### ENGLISH



This symbol on the product or packaging means that according to local laws and regulations this product should be not be disposed of in household waste but sent for recycling. Please take it to a collection point designated by your local authorities once it has reached the end of its life, some will accept products for free. By recycling the product and its packaging in this manner you help to conserve the environment and protect human health.

### D-Link and the Environment

At D-Link, we understand and are committed to reducing any impact our operations and products may have on the environment. To minimise this impact D-Link designs and builds its products to be as environmentally friendly as possible, by using recyclable, low toxic materials in both products and packaging.

D-Link recommends that you always switch off or unplug your D-Link products when they are not in use. By doing so you will help to save energy and reduce CO2 emissions.

To learn more about our environmentally responsible products and packaging please visit [www.dlinkgreen.com](http://www.dlinkgreen.com).

### DEUTSCH

DE



Dieses Symbol auf dem Produkt oder der Verpackung weist darauf hin, dass dieses Produkt gemäß bestehender örtlicher Gesetze und Vorschriften nicht über den normalen Hausmüll entsorgt werden sollte, sondern einer Wiederverwertung zuzuführen ist. Bringen Sie es bitte zu einer von Ihrer Kommunalbehörde entsprechend amtlich ausgewiesenen Sammelstelle, sobald das Produkt das Ende seiner Nutzungsdauer erreicht hat. Für die Annahme solcher Produkte erheben einige dieser Stellen keine Gebühren. Durch ein auf diese Weise durchgeführtes Recycling des Produkts und seiner Verpackung helfen Sie, die Umwelt zu schonen und die menschliche Gesundheit zu schützen.

### D-Link und die Umwelt

D-Link ist sich den möglichen Auswirkungen seiner Geschäftstätigkeiten und seiner Produkte auf die Umwelt bewusst und fühlt sich verpflichtet, diese entsprechend zu mindern. Zu diesem Zweck entwickelt und stellt D-Link seine Produkte mit dem Ziel größtmöglicher Umweltfreundlichkeit her und verwendet wiederverwertbare, schadstoffarme Materialien bei Produktherstellung und Verpackung.

D-Link empfiehlt, Ihre Produkte von D-Link, wenn nicht in Gebrauch, immer auszuschalten oder vom Netz zu nehmen. Auf diese Weise helfen Sie, Energie zu sparen und CO2-Emissionen zu reduzieren.

Wenn Sie mehr über unsere umweltgerechten Produkte und Verpackungen wissen möchten, finden Sie entsprechende Informationen im Internet unter [www.dlinkgreen.com](http://www.dlinkgreen.com).



**FRANÇAIS****FR**

Ce symbole apposé sur le produit ou son emballage signifie que, conformément aux lois et réglementations locales, ce produit ne doit pas être éliminé avec les déchets domestiques mais recyclé. Veuillez le rapporter à un point de collecte prévu à cet effet par les autorités locales; certains accepteront vos produits gratuitement. En recyclant le produit et son emballage de cette manière, vous aidez à préserver l'environnement et à protéger la santé de l'homme.

**D-Link et l'environnement**

Chez D-Link, nous sommes conscients de l'impact de nos opérations et produits sur l'environnement et nous engageons à le réduire. Pour limiter cet impact, D-Link conçoit et fabrique ses produits de manière aussi écologique que possible, en utilisant des matériaux recyclables et faiblement toxiques, tant dans ses produits que ses emballages.

D-Link recommande de toujours éteindre ou débrancher vos produits D-Link lorsque vous ne les utilisez pas. Vous réaliserez ainsi des économies d'énergie et réduirez vos émissions de CO<sub>2</sub>.

Pour en savoir plus sur les produits et emballages respectueux de l'environnement, veuillez consulter le [www.dlinkgreen.com](http://www.dlinkgreen.com).

**ESPAÑOL****ES**

Este símbolo en el producto o el embalaje significa que, de acuerdo con la legislación y la normativa local, este producto no se debe desechar en la basura doméstica sino que se debe reciclar. Llévelo a un punto de recogida designado por las autoridades locales una vez que ha llegado al fin de su vida útil; algunos de ellos aceptan recogerlos de forma gratuita. Al reciclar el producto y su embalaje de esta forma, contribuye a preservar el medio ambiente y a proteger la salud de los seres humanos.

**D-Link y el medio ambiente**

En D-Link, comprendemos y estamos comprometidos con la reducción del impacto que puedan tener nuestras actividades y nuestros productos en el medio ambiente. Para reducir este impacto, D-Link diseña y fabrica sus productos para que sean lo más ecológicos posible, utilizando materiales reciclables y de baja toxicidad tanto en los productos como en el embalaje.

D-Link recomienda apagar o desenchufar los productos D-Link cuando no se estén utilizando. Al hacerlo, contribuirá a ahorrar energía y a reducir las emisiones de CO<sub>2</sub>.

Para obtener más información acerca de nuestros productos y embalajes ecológicos, visite el sitio [www.dlinkgreen.com](http://www.dlinkgreen.com).

**ITALIANO****IT**

La presenza di questo simbolo sul prodotto o sulla confezione del prodotto indica che, in conformità alle leggi e alle normative locali, questo prodotto non deve essere smaltito nei rifiuti domestici, ma avviato al riciclo. Una volta terminato il ciclo di vita utile, portare il prodotto presso un punto di raccolta indicato dalle autorità locali. Alcuni questi punti di raccolta accettano gratuitamente i prodotti da riciclare. Scegliendo di riciclare il prodotto e il relativo imballaggio, si contribuirà a preservare l'ambiente e a salvaguardare la salute umana.

**D-Link e l'ambiente**

D-Link cerca da sempre di ridurre l'impatto ambientale dei propri stabilimenti e dei propri prodotti. Allo scopo di ridurre al minimo tale impatto, D-Link progetta e realizza i propri prodotti in modo che rispettino il più possibile l'ambiente, utilizzando materiali riciclabili a basso tasso di tossicità sia per i prodotti che per gli imballaggi.

D-Link raccomanda di spegnere sempre i prodotti D-Link o di scollegarne la spina quando non vengono utilizzati. In questo modo si contribuirà a risparmiare energia e a ridurre le emissioni di anidride carbonica.

Per ulteriori informazioni sui prodotti e sugli imballaggi D-Link a ridotto impatto ambientale, visitate il sito all'indirizzo [www.dlinkgreen.com](http://www.dlinkgreen.com).

**NEDERLANDS****NL**

Dit symbool op het product of de verpakking betekent dat dit product volgens de plaatselijke wetgeving niet mag worden weggegooid met het huishoudelijk afval, maar voor recyclage moeten worden ingeleverd. Zodra het product het einde van de levensduur heeft bereikt, dient u het naar een inzamelpunt te brengen dat hiertoe werd aangeduid door uw plaatselijke autoriteiten, sommige autoriteiten accepteren producten zonder dat u hiervoor dient te betalen. Door het product en de verpakking op deze manier te recyclen helpt u het milieu en de gezondheid van de mens te beschermen.

**D-Link en het milieu**

Bij D-Link spannen we ons in om de impact van onze handelingen en producten op het milieu te beperken. Om deze impact te beperken, ontwerpt en bouwt D-Link zijn producten zo milieuvriendelijk mogelijk, door het gebruik van recycleerbare producten met lage toxiciteit in product en verpakking.

D-Link raadt aan om steeds uw D-Link producten uit te schakelen of uit de stekker te halen wanneer u ze niet gebruikt. Door dit te doen bespaart u energie en beperkt u de CO<sub>2</sub>-emissies.

Breng een bezoek aan [www.dlinkgreen.com](http://www.dlinkgreen.com) voor meer informatie over onze milieuverantwoorde producten en verpakkingen.

**POLSKI****PL**

Ten symbol umieszczony na produkcie lub opakowaniu oznacza, że zgodnie z miejscowym prawem i lokalnymi przepisami niniejszego produktu nie wolno wyrzucać jak odpady czy śmieci z gospodarstwa domowego, lecz należy go poddać procesowi recyklingu. Po zakończeniu użytkowania produktu, niektóre odpowiednie do tego celu podmioty przyjmą takie produkty nieodpłatnie, dlatego prosimy dostarczyć go do punktu zbiórki wskazanego przez lokalne władze. Poprzez proces recyklingu i dzięki takiemu postępowaniu z produktem oraz jego opakowaniem, pomogą Państwo chronić środowisko naturalne i dbać o ludzkie zdrowie.

**D-Link i środowisko**

D-Link podchodzimy w sposób świadomy do ochrony otoczenia oraz jesteśmy zaangażowani w zmniejszanie wpływu naszych działań i produktów na środowisko naturalne. W celu zminimalizowania takiego wpływu firma D-Link konstruuje i wytwarza swoje produkty w taki sposób, aby były one jak najbardziej przyjazne środowisku, stosując do tych celów materiały nadające się do powtórnego wykorzystania, charakteryzujące się małą toksycznością zarówno w przypadku samych produktów jak i opakowań.

Firma D-Link zaleca, aby Państwo zawsze prawidłowo wyłączali z użytku swoje produkty D-Link, gdy nie są one wykorzystywane. Postępując w ten sposób pozwalają Państwo oszczędzać energię i zmniejszać emisje CO<sub>2</sub>.

Aby dowiedzieć się więcej na temat produktów i opakowań mających wpływ na środowisko prosimy zapoznać się ze stroną Internetową [www.dlinkgreen.com](http://www.dlinkgreen.com).

**ČESKY****CZ**

Tento symbol na výrobku nebo jeho obalu znamená, že podle místně platných předpisů se výrobek nesmí vyhazovat do komunálního odpadu, ale odeslat k recyklaci. Až výrobek doslouží, odnese jej prosím na sběrné místo určené místními úřady k tomuto účelu. Některá sběrná místa přijímají výrobky zdarma. Recyklací výrobku i obalu pomáháte chránit životní prostředí i lidské zdraví.

**D-Link a životní prostředí**

Ve společnosti D-Link jsme si vědomi vlivu našich provozů a výrobků na životní prostředí a snažíme se o minimalizaci těchto vlivů. Proto své výrobky navrhujeme a vyrábíme tak, aby byly co nejekologičtější, a ve výrobcích i obalech používáme recyklovatelné a nízkotoxické materiály.

Společnost D-Link doporučuje, abyste své výrobky značky D-Link vypnuli nebo vytáhli ze zásuvky vždy, když je nepoužíváte. Pomůžete tak šetřit energii a snížit emise CO<sub>2</sub>.

Více informací o našich ekologických výrobcích a obalech najdete na adrese [www.dlinkgreen.com](http://www.dlinkgreen.com).

**MAGYAR****HU**

Ez a szimbólum a terméken vagy a csomagoláson azt jelenti, hogy a helyi törvényeknek és szabályoknak megfelelően ez a termék nem semmisíthető meg a háztartási hulladékkal együtt, hanem újrahasznosításra kell küldeni. Kérjük, hogy a termék élettartamának elteltét követően vigye azt a helyi hatóság által kijelölt gyűjtőhelyre. A termékek egyes helyeken ingyen elhelyezhetők. A termék és a csomagolás újrahasznosításával segíti védeni a környezetet és az emberek egészségét.

**A D-Link és a környezet**

A D-Linknél megértjük és elköteleztük magunkat a műveleteink és termékeink környezetre gyakorolt hatásainak csökkentésére. Az ezen hatás csökkentése érdekében a D-Link a lehető leginkább környezetbarát termékeket tervez és gyárt azáltal, hogy újrahasznosítható, alacsony károsanyag-tartalmú termékeket gyárt és csomagolásokat alkalmaz.

A D-Link azt javasolja, hogy mindig kapcsolja ki vagy húzza ki a D-Link termékeket a tápforrásból, ha nem használja azokat. Ezzel segít az energia megtakarításában és a széndioxid kibocsátásának csökkentésében.

Környezetbarát termékeinkről és csomagolásainkról további információkat a [www.dlinkgreen.com](http://www.dlinkgreen.com) weboldalon tudhat meg.

**NORSK****NO**

Dette symbolet på produktet eller forpakningen betyr at dette produktet ifølge lokale lover og forskrifter ikke skal kastes sammen med husholdningsavfall, men leveres inn til gjenvinning. Vennligst ta det til et innsamlingssted anvist av lokale myndigheter når det er kommet til slutten av levetiden. Noen steder aksepteres produkter uten avgift. Ved på denne måten å gjenvinne produktet og forpakningen hjelper du å verne miljøet og beskytte folks helse.

**D-Link og miljøet**

Hos D-Link forstår vi oss på og er forpliktet til å minske innvirkningen som vår drift og våre produkter kan ha på miljøet. For å minimalisere denne innvirkningen designer og lager D-Link produkter som er så miljøvennlig som mulig, ved å bruke resirkulerbare, lav-toksiske materialer både i produktene og forpakningen.

D-Link anbefaler at du alltid slår av eller frakobler D-Link-produkter når de ikke er i bruk. Ved å gjøre dette hjelper du å spare energi og å redusere CO<sub>2</sub>-utslipp.

For mer informasjon angående våre miljøansvarlige produkter og forpakninger kan du gå til [www.dlinkgreen.com](http://www.dlinkgreen.com).

**DANSK****DK**

Dette symbol på produktet eller emballagen betyder, at dette produkt i henhold til lokale love og regler ikke må bortskaffes som husholdningsaffald, mens skal sendes til genbrug. Indlever produktet til et indsamlingssted som angivet af de lokale myndigheder, når det er nået til slutningen af dets levetid. I nogle tilfælde vil produktet blive modtaget gratis. Ved at indlevere produktet og dets emballage til genbrug på denne måde bidrager du til at beskytte miljøet og den menneskelige sundhed.

**D-Link og miljøet**

Hos D-Link forstår vi og bestræber os på at reducere enhver indvirkning, som vores aktiviteter og produkter kan have på miljøet. For at minimere denne indvirkning designer og producerer D-Link sine produkter, så de er så miljøvenlige som muligt, ved at bruge genanvendelige materialer med lavt giftighedsniveau i både produkter og emballage.

D-Link anbefaler, at du altid slukker eller frakobler dine D-Link-produkter, når de ikke er i brug. Ved at gøre det bidrager du til at spare energi og reducere CO2-udledningerne.

Du kan finde flere oplysninger om vores miljømæssigt ansvarlige produkter og emballage på [www.dlinkgreen.com](http://www.dlinkgreen.com).

**SUOMI****FI**

Tämä symboli tuotteen pakkauksessa tarkoittaa, että paikallisten lakien ja säännösten mukaisesti tätä tuotetta ei pidä hävittää yleisen kotitalousjätteen seassa vaan se tulee toimittaa kierrätettäväksi. Kun tuote on elinkaarensa päässä, toimita se lähimpään viranomaisten hyväksymään kierrätyspisteeseen. Kierrättämällä käytetyn tuotteen ja sen pakkauksen autat tukemaan sekä ympäristön että ihmisten terveyttä ja hyvinvointia.

**D-Link ja ympäristö**

D-Link ymmärtää ympäristönsuojelun tärkeyden ja on sitoutunut vähentämään tuotteistaan ja niiden valmistuksesta ympäristölle mahdollisesti aiheutuvia haittavaikutuksia. Nämä negatiiviset vaikutukset minimoidakseen D-Link suunnittelee ja valmistaa tuotteensa mahdollisimman ympäristöystävällisiksi käyttämällä kierrätettäviä, alhaisia pitoisuuksia haitallisia aineita sisältäviä materiaaleja sekä tuotteissaan että niiden pakkauksissa.

Suosittellemme, että irrotat D-Link-tuotteesi virtalähteestä tai sammutat ne aina, kun ne eivät ole käytössä. Toimimalla näin autat säästämään energiaa ja vähentämään hiilidioksiidipäästöjä.

Lue lisää ympäristöystävällisistä D-Link-tuotteista ja pakkauksistamme osoitteesta [www.dlinkgreen.com](http://www.dlinkgreen.com).

**SVENSKA****SE**

Den här symbolen på produkten eller förpackningen betyder att produkten enligt lokala lagar och föreskrifter inte skall kastas i hushållssoporna utan i stället återvinnas. Ta den vid slutet av dess livslängd till en av din lokala myndighet utsedd uppsamlingsplats, vissa accepterar produkter utan kostnad. Genom att på detta sätt återvinna produkten och förpackningen hjälper du till att bevara miljön och skydda människors hälsa.

**D-Link och miljön**

På D-Link förstår vi och är fast beslutna att minska den påverkan våra verksamheter och produkter kan ha på miljön. För att minska denna påverkan utformar och bygger D-Link sina produkter för att de ska vara så miljövänliga som möjligt, genom att använda återvinningsbara material med låg gifthalt i både produkter och förpackningar.

D-Link rekommenderar att du alltid stänger av eller kopplar ur dina D-Link produkter när du inte använder dem. Genom att göra detta hjälper du till att spara energi och minska utsläpp av koldioxid.

För mer information om våra miljöansvariga produkter och förpackningar [www.dlinkgreen.com](http://www.dlinkgreen.com).

**PORTUGUÊS****PT**

Este símbolo no produto ou embalagem significa que, de acordo com as leis e regulamentações locais, este produto não deverá ser eliminado juntamente com o lixo doméstico mas enviado para a reciclagem. Transporte-o para um ponto de recolha designado pelas suas autoridades locais quando este tiver atingido o fim da sua vida útil, alguns destes pontos aceitam produtos gratuitamente. Ao reciclar o produto e respectiva embalagem desta forma, ajuda a preservar o ambiente e protege a saúde humana.

**A D-Link e o ambiente**

Na D-Link compreendemos e comprometemo-nos com a redução do impacto que as nossas operações e produtos possam ter no ambiente. Para minimizar este impacto a D-Link concebe e constrói os seus produtos para que estes sejam o mais inofensivos para o ambiente possível, utilizando materiais recicláveis e não tóxicos tanto nos produtos como nas embalagens.

A D-Link recomenda que desligue os seus produtos D-Link quando estes não se encontrarem em utilização. Com esta acção ajudará a poupar energia e reduzir as emissões de CO<sub>2</sub>.

Para saber mais sobre os nossos produtos e embalagens responsáveis a nível ambiental visite [www.dlinkgreen.com](http://www.dlinkgreen.com).