

DCS-6815/6817/6818

Version 1.3

# High Speed Dome Network Camera



## User Manual

Business Class Networking

# Table of Contents

<b>Product Overview</b> .....	<b>3</b>	Add Server .....	46
Package Contents .....	3	Add Media.....	47
System Requirements .....	3	Add Event .....	50
Introduction .....	4	Recording .....	51
Features .....	4	Advanced.....	52
Warnings .....	5	DI and DO (Digital Input/Output).....	52
<b>Hardware Installation</b> .....	<b>6</b>	ICR.....	53
Basic Hardware Setup .....	6	HTTPS .....	54
Resetting the Camera.....	12	Access List.....	55
Standard or Mini Pendant Mount.....	13	Maintenance .....	56
Ceiling Mounting - Straight Tube .....	14	Admin.....	56
Live Video .....	24	Backup and Restore .....	57
Setup .....	27	Firmware Upgrade .....	58
Internet Connection Setup Wizard.....	27	Status .....	59
Motion Detection Setup Wizard .....	30	Device Info .....	59
Network Setup .....	32	Logs .....	60
Dynamic DNS .....	34	Help .....	61
Image Setup .....	35	<b>DI/DO Configuration</b> .....	<b>62</b>
Audio and Video .....	37	DI/DO Pin Block Specifications .....	62
PTZ Setup.....	38	Digital Input Diagram .....	63
Preset .....	40	Digital Output Diagram .....	64
Motion Detection.....	42	<b>Troubleshooting</b> .....	<b>65</b>
Time and Date .....	43	<b>Technical Specifications</b> .....	<b>66</b>
Event Setup .....	44		
Application .....	45		

# Package Contents

- DCS-6815/6817/6818 High Speed Dome Network Camera
- Data Cable for Video, Alarm, and Power (AC 24V)
- Power Adapter
- Power Cable
- Waterproof Collar
- Optical Cover
- Manual and Software on CD
- Quick Installation Guide
- Screws
- Lubricant
- Mini Pendant

If any of the above items are missing, please contact your reseller.

# System Requirements

- CPU: Pentium 4 1.4GHz or above
- Hard Disk: 40GB or above
- Memory: 256MB or above
- Browser: Internet Explorer 6.0 or above
- Video Resolution: SVGA or XGA (1024x768 or above)

# Introduction

The DCS-6815/6817/6818 High Speed High Speed Dome Network Camera is a professional IP surveillance solution which connect to your network to provide high-quality live video over the Internet. The camera apparatus supports precise high-speed pan/tilt/zoom functionality for extensive monitoring, and object tracking. The inconspicuous dome enclosure can be mounted in a variety of positions based on your needs.

## Features

### **Real-time H.264 / MPEG-4 / MJPEG Compression**

The IP speed Dome Camera supports three selectable compression codecs (H.264/MPEG-4/MJPEG).

### **Up to 30fps at D1 Resolution**

The IP speed Dome Camera supports up to 30fps (NTSC) or 25fps (PAL) at D1 resolution.

### **Motion Detection**

Users can specify a detection area and adjust motion detection sensitivity.

### **Supports Multiple Connections**

The IP speed Dome Camera allows multiple users to log in via the IE browser. Maximum 10 accounts can be set for one camera.

### **Upgrade from Internet**

Users can upgrade to the latest software version via the Internet.

# Warnings

**Handle the camera with care.**

Do not abuse the camera. Avoid striking, shaking, or otherwise disturbing the enclosure. Improper handling or storage may damage the camera.

**Install electrical wiring carefully.**

Consult a qualified electrician regarding camera installation. Please note that the camera's electrical input tolerance is AC 24V  $\pm$  10%. Ensure that the AC adapter's power cable is grounded appropriately to protect against power surges.

**Do not disassemble the camera.**

To prevent electric shock, do not remove screws or covers. Consult D-Link regarding service if necessary.

**Do not block the cooling holes on the bracket.**

This camera has a cooling fan inside. Blocking the cooling holes will lead to overheating and may cause damage.

**Do not operate the camera beyond the specified temperature, humidity or power source ratings.**

Use the camera under conditions where the temperature is between -40° ~ 50° C (-40° ~ 122° F), and relative humidity is below 80%.

**Do not use strong or abrasive detergents when cleaning the camera body.**

Use a dry cloth to clean the camera when it is dirty. A mild detergent can be used if necessary.

**Never aim the camera towards the sun.**

Never aim the camera at the sun or other extremely bright light sources, even when the camera is not in use. Doing so may cause damage to the camera's sensors.

# Hardware Installation

## Basic Hardware Setup

### STEP 1

Unpack the DCS-6815/6817/6818 and remove the dome camera unit.



### STEP 2

Rotate the cap and remove it from the camera body.



**STEP 3**

Remove the protective cover and PE sheet.



**STEP 4**

Apply some lubricant on the cover's waterproof seal to make the installation process smoother. Attach the optical cover to the camera body.



The small protrusions on the cover must align with the four holes on the camera body.



**STEP 5**

Gently press down the dome cover with two hands on the side of it.



**Warning:** DO NOT press down on the cover, as shown in the figure; this might cause damage to the camera.



**STEP 6**

Screw the dome cover and body together.





**STEP 7**

Insert the data cable into the opening on the cap.



**STEP 8**

Connect the 22-pin connector to the slot on the camera enclosure.  
The connector will lock into place.



**STEP 9**

Connect the power cable to the power adapter.



**STEP 10**

Connect the power adapter's 3-pin connector to the camera's 3-pin power connector.



### **STEP 11**

Connect one end of the CAT 5 Ethernet cable to the RJ-45 connector of the camera enclosure, and the other end of the cable to your network.



### **STEP 12**

Plug the power cable into a wall outlet.

### **Important Notice:**

The DCS-6815/6817/6818 can operate at temperatures between -40° and 50° C. However, the power adapter is only designed to operate between 0° and 40° C. For locations which will experience temperatures outside of this range, the camera may need to draw power from a difference source, such as a building's emergency/ backup power system.

# Resetting the Camera

The DCS-6815/6817/6818 contains both digital and mechanical components. Thus, if any problems are experienced with the camera, there are two different reset options depending on the type of problem.

## Mechanical Reset

If the mechanical PTZ controls ever stop responding or seem to be locked up, you may reset the mechanical portion of the camera using the communication pin array at the base of the device.

1. Use a small tool to move switch 5 to the “off” position.
2. Plug the camera in for one minute and allow the device to initialize.
3. Return the pin back to its original “on” position.
4. Plug in the camera, and the device should successfully initialize.

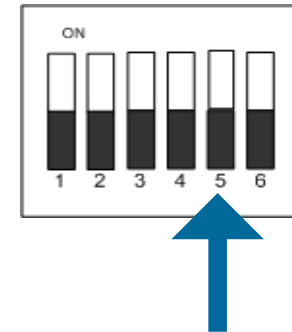

## Digital Reset

If the camera’s web user interface ever becomes unresponsive, or if the administrator password is forgotten, it may become necessary to reset the device firmware to its original factory settings.

1. Press and hold the green button on the base of the camera for 10 seconds.
2. Allow a few minutes for the camera to re-initialize factory default settings.



# Standard or Mini Pendant Mount

Follow the steps below to mount the camera enclosure with the pendant mount.

1. Make a cable entry hole on the wall to recess the cables. Alternatively, cables can be threaded through the cable entry hole on the mounting plate.
2. To prevent insects from entering the pendant mount, you may block the cable entry hole with the supplied sponge in two different ways. (See figures 1 and 2.)
3. Thread the cables through the pendant mount and affix the pendant mount on the wall with screws and screw anchors (not supplied).
4. Attach the waterproof collar to the pendant mount.
5. Thread the cables through the cap and affix it to the pendant mount with the supplied screws and washers.
6. Connect the cables to the camera enclosure. Attach the camera enclosure to the mount and affix it with the supplied bolt.

**Note:** After threading the cables, please block the cable entry hole with the supplied sponges to prevent insects from entering the tube.

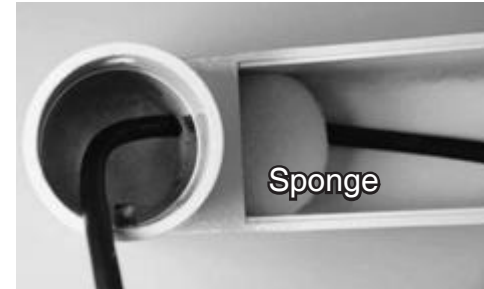
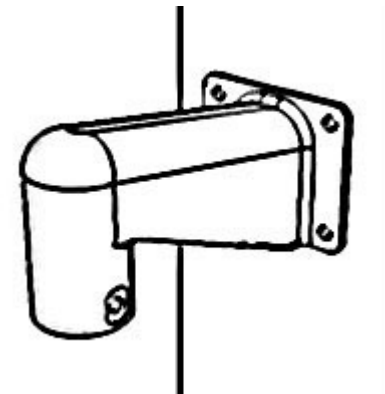

Figure 1



Figure 2



# Ceiling Mounting - Straight Tube

Follow the steps below to mount the camera enclosure with the straight tube.

1. Ensure that the ceiling can support the weight of the camera enclosure and straight tube.
2. Make a cable entry hole on the ceiling.
3. Affix the straight tube to the ceiling with screws and screw anchors (not supplied).
4. Attach the waterproof collar to the straight tube.
5. Thread the cables through the straight tube and the cap.
6. Affix the cap to the straight tube with the supplied screws and washers. Attach the waterproof collar around the junction of the straight tube and cap.
7. Connect the cables to the camera enclosure. Attach the camera enclosure to the cap and affix it with the supplied bolt.

**Note:** After threading the cables, please block the cable entry hole with the supplied sponges to prevent insects from entering the tube.

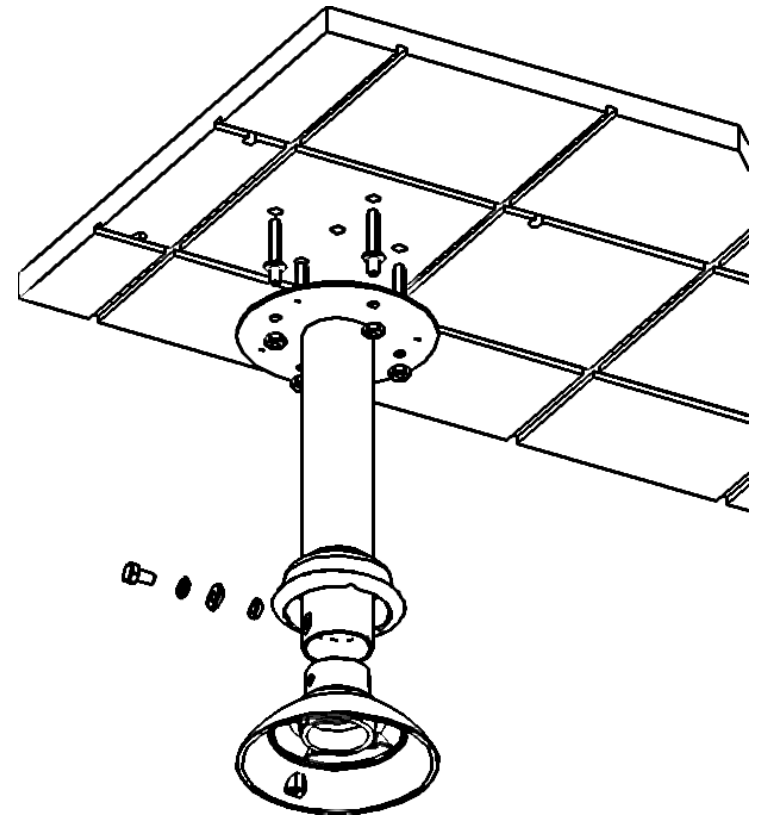

# Configuration with Wizard

Insert the DCS-681X series CD into your computer's CD-ROM drive to begin the installation. If the Autorun function on your computer is disabled, or if the D-Link Launcher fails to start automatically, click **Start > Run**. Type **D:\autorun.exe**, where D: represents the drive letter of your CD-ROM drive.

Click **Setup Wizard** to begin the installation.



Click **Next** to continue.

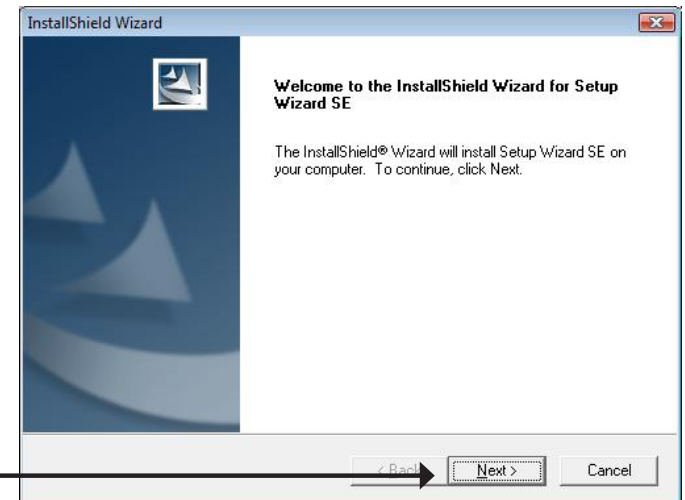

Click **Yes** to accept the License Agreement.

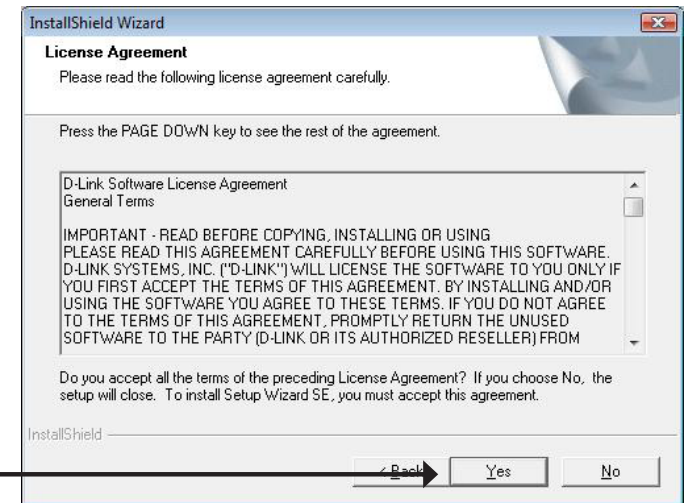

To start the installation process, click **Next**.

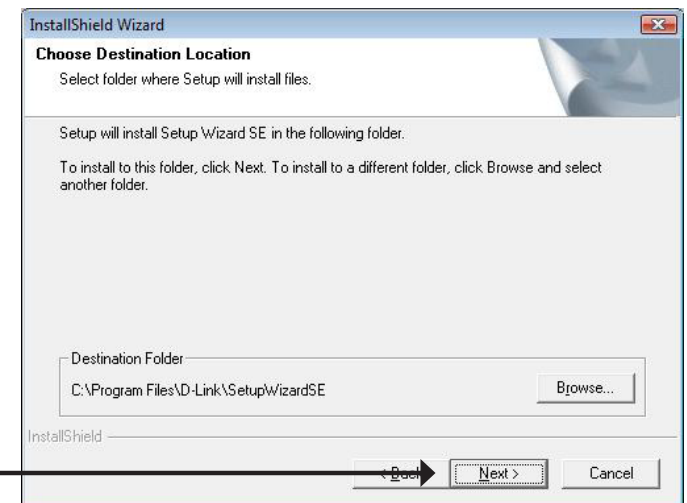

**Note:** The installation may take several minutes to finish.



Click **Finish** to complete the installation.

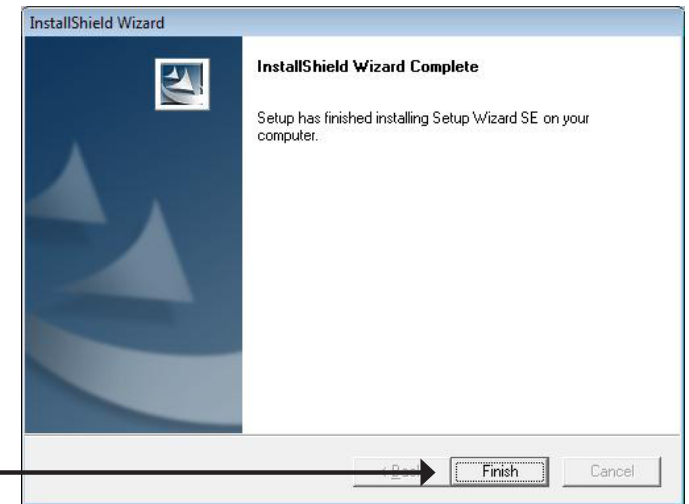

Click on the **D-Link Setup Wizard SE** icon that was created in your Windows Start menu.

**Start > D-Link > Setup Wizard SE**

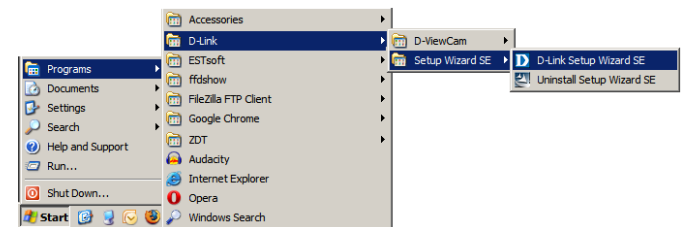

The Setup Wizard will appear and display the MAC address and IP address of your camera(s). If you have a DHCP server on your network, a valid IP Address will be displayed. If your network does not use a DHCP server, the network camera's default static IP address **192.168.0.20** will be displayed.

Click the **Wizard** button to continue.



Enter the Admin ID and password. When logging in for the first time, the default Admin ID is **admin** with the password left blank.

Click **Next**, to proceed to the next page.



Select **DHCP** if your camera obtains an IP address automatically when it boots up. Select **Static IP** if the camera will use the same IP address each time it is started.

Click **Next**, to proceed to the next page.

D-Link Building Networks for People

SECURICAM Network

### Set IP Address

DHCP

Static IP

IP Address: 192.168.1.185

Subnet Mask: 255.255.255.0

Default Gateway: 192.168.1.1

Primary DNS: 192.168.1.1

Secondary DNS: 192.168.1.1

Back Next Exit

Take a moment to confirm your settings and click **Restart**.

D-Link Building Networks for People

SECURICAM Network

Admin ID: admin

Password:

IP Address: 192.168.0.102

Subnet Mask: 255.255.255.0

Primary DNS: 192.168.0.1

Secondary DNS: 192.168.0.1

The Setup Wizard has completed. Click on 'Back' to modify your settings. Click 'Restart' to save your current settings and reboot the Internet Camera.

Back Restart

# Web-based Configuration Utility

This section explains how to configure your new D-Link Network Camera using the Web-based Configuration Utility.

Click on the **D-Link Setup Wizard SE** icon that was created in your Windows Start menu.

**Start > D-Link > Setup Wizard SE**

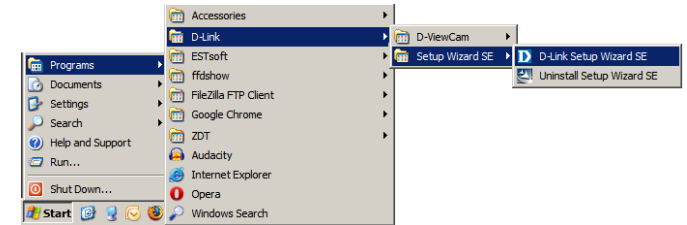

Select the camera and click the button labeled "**Link**" to access the web configuration.

The Setup Wizard will automatically open your web browser to the IP address of the camera.



Alternatively, you may manually open a browser and enter the IP address of the camera: **192.168.0.20**

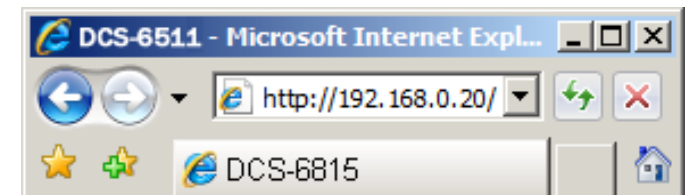

Enter **admin** as the default username and leave the password blank. Click **OK** to continue.

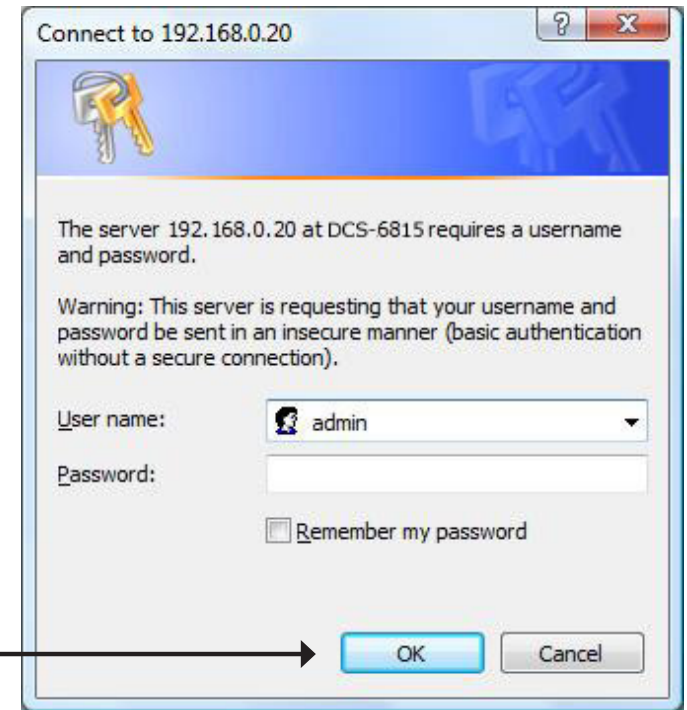

This section shows your camera's live video. You can select your video profile and view or operate the camera. For additional information about web configuration, please refer to the user manual included on the CD-ROM or the D-Link website.



# D-ViewCam Setup Wizard

D-ViewCam software is included for the administrator to manage multiple D-Link IP cameras remotely. You may use the software to configure all the advanced settings for your cameras. D-ViewCam is a comprehensive management tool for IP surveillance.

Insert the CD into the CD-ROM drive. Click "Install D-ViewCam Software" from menu, and select "D-ViewCam" to install the VMS software.

Follow the Installation Wizard to install D-ViewCam.

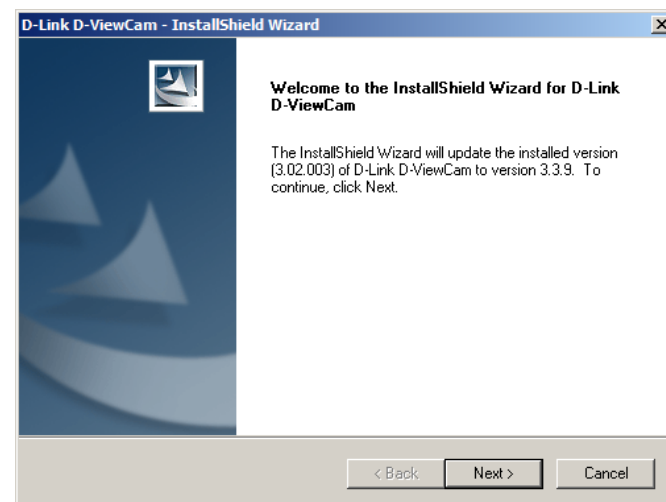

Click **Finish** to complete the installation.

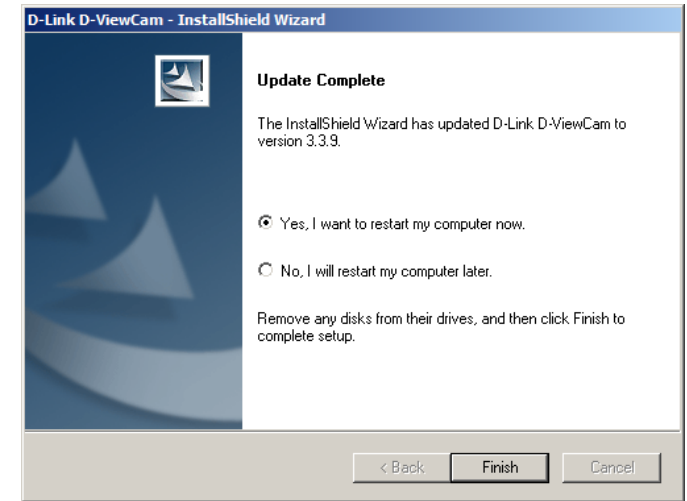

To start D-ViewCam, select **Start > All Programs > D-Link D-ViewCam > Main Console**.

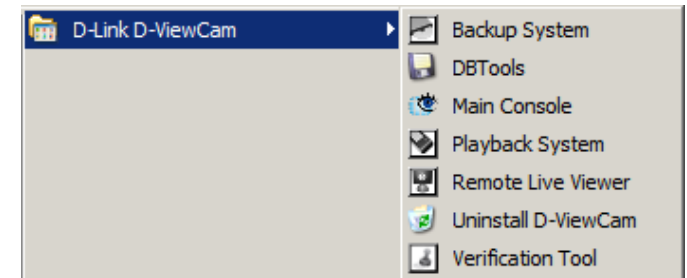

For more detail operation of using D-ViewCam software, please refer to D-ViewCam Manual.

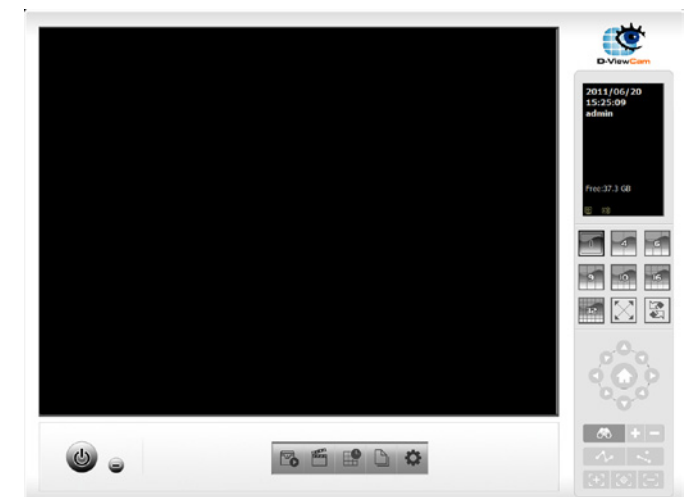

# Live Video

This page displays live video and allows you to adjust and save camera images.

**On-screen Display (OSD):** The date, time, and camera name are displayed at the top left corner of the live video display.



**Digital Input Indicators (1-8):** These indicators blink when digital input is received.



**Motion Trigger Indicator:** This indicator blinks when motion is detected.



**Recording Indicator:** This indicator blinks when the camera is recording.

**Navigation Pad:** The navigation pad is used to carry out pan, tilt, and zoom functions. The camera can be aimed and the image adjusted using this pad.  
**(Up/Down/Left/Right/Home Zoom In/Zoom Out)**

**Note:** The **Home** position of the dome camera not configured by default. Please see page 40 for information about how to configure the home position.

**Pan Speed:** There are 16 speeds for pan control. 1 is the slowest and 16 is the fastest.

**Tilt Speed:** There are 16 speeds for pan control. 1 is the slowest and 16 is the fastest.







**AutoPan:** Starts a pre-defined AutoPan movement. Select the number corresponding a predefined path.



**Sequence:** Starts a pre-defined sequence movement. Select the number corresponding a predefined path.



**Cruise:** Starts a pre-defined cruise movement. Select the number corresponding a predefined path.



**Autofocus (AF):** Click this button to enable automatic focus.



**Manual Focus (MF):** Click this button to manually focus the camera image.



**Focus:** Use these controls to focus the camera image.

**Language:** You may select **English** or **Traditional Chinese**.



**Fullscreen:** Loads the live camera image in fullscreen.



**Snapshot:** Saves a snapshot of the image to the specified location.



**Start/Stop Recording:** Begins recording to the specified location. Pressing this button a second time will stop the recording.



**Set Storage Folder:** Designates a folder where snapshots and video will be saved.





**Start/Stop Digital Output:** Sends a signal to the attached digital device.





**Profile 1-3:** Select one of three predefined video profiles to display in the Live Video window.

 **Start/Stop Listening:** Click this button to begin listening to the audio feed from a microphone connected to the camera (audio in).

 **Start/Stop Talking:** Click this button to begin sending audio to speakers connected to the camera (audio out).

GoTo

**Go To (Preset):** Selecting a preset from this list will load the preset in the Live Video windows.

# Setup

To configure your Network Camera, click **Internet Connection Setup Wizard**. Alternatively, you may click **Manual Internet Connection Setup** to manually configure your Network Camera and skip to page 32.

To quickly configure your Network Camera's motion detection settings, click **Motion Detection Setup Wizard**. If you want to enter your settings without running the wizard, click **Manual Motion Detection Setup** and skip to page 42.

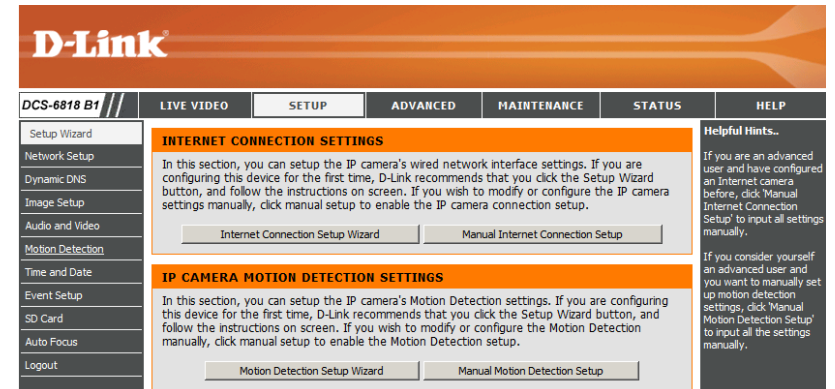

## Internet Connection Setup Wizard

This wizard will guide you through a step-by-step process to configure your new D-Link Camera and connect the camera to the internet. Click **Next** to continue.

**Note:** Select DHCP if you are unsure of which settings to choose.

Click **Next** to continue.

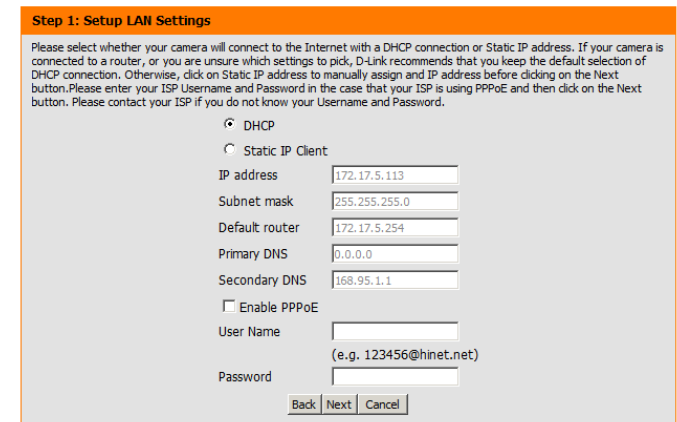
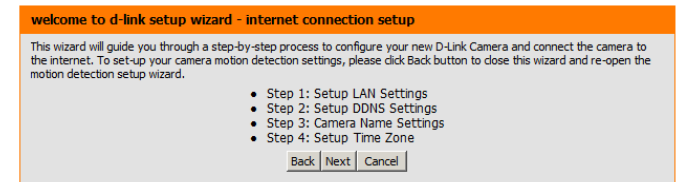

Select **Static IP** if your Internet Service Provider has provided you with connection settings, or if you wish to set a static address within your home network. Enter the correct configuration information and click **Next** to continue.

If you are using PPPoE, select **Enable PPPoE** and enter your user name and password, otherwise click **Next** to continue.

If you have a Dynamic DNS account and would like the camera to update your IP address automatically, Select **Enable DDNS** and enter your host information. Click **Next** to continue.

Enter a name for your camera and click **Next** to continue.

**Step 1: Setup LAN Settings**

Please select whether your camera will connect to the Internet with a DHCP connection or Static IP address. If your camera is connected to a router, or you are unsure which settings to pick, D-Link recommends that you keep the default selection of DHCP connection. Otherwise, click on Static IP address to manually assign and IP address before clicking on the Next button. Please enter your ISP Username and Password in the case that your ISP is using PPPoE and then click on the Next button. Please contact your ISP if you do not know your Username and Password.

DHCP  
 Static IP Client

IP address   
Subnet mask   
Default router   
Primary DNS   
Secondary DNS

Enable PPPoE  
User Name   
(e.g. 123456@hinet.net)  
Password

**Step 2: Setup DDNS Settings**

If you have a Dynamic DNS account and would like the camera to update your IP address automatically, enable DDNS and enter in your host information below. Please click on the Next button to continue.

Enable DDNS

Server Address  <<

Host Name   
User Name   
Password   
Verify Password   
Timeout  (hours)

**Step 3: Camera Name Settings**

D-Link recommends that you rename your camera for easy accessibility. You can then identify and connect to your camera via this name. Please assign a name of your choice before clicking on the Next button.

IP Camera Name

Configure the correct time to ensure that all events will be triggered as scheduled. Click **Next** to continue.

If you have selected DHCP, you will see a summary of your settings, including the camera's IP address. Please write down all of this information as you will need it in order to access your camera.

Click **Apply** to save your settings.

**Step 4: Setup Time Zone**

Please configure the correct time to ensure that all events are triggered, captured and scheduled at the correct time and day and then click on the Next button.

Time Zone

Enable Daylight Saving

**Step 5: Setup complete**

Below is a summary of your camera settings. Click on the Back button to review or modify settings or click on the Apply button if all settings are correct. It is recommended to note down these settings in order to access your camera on the network or via your web browser.

IP Address	DHCP
IP Camera Name	DCS-6818
Time Zone	(GMT+08:00) Taipei
DDNS	Disable
PPPoE	Disable

# Motion Detection Setup Wizard

This wizard will guide you through a step-by-step process to configure your camera's motion detection functions.

Click **Next** to continue.

## Step 1

This step will allow you to enable or disable motion detection, specify the detection sensitivity, and adjust the camera's ability to detect movement.

You may specify whether the camera should capture a snapshot or a video clip when motion is detected.

Please see the **Motion Detection** section on page 43 for information about how to configure motion detection.

## Step 2

This step allows you to enable motion detection based on a customized schedule. Specify the day and hours. You may also choose to always record motion.

### welcome to d-link setup wizard - motion detection

This wizard will guide you through a step-by-step process to configure your camera's motion detection functions. To setup the camera LAN or Internet settings, please click on the Back button to close this wizard and re-open the Camera Setup wizard. Otherwise click on the Next button to begin.

- Step 1: Specify Motion Detection Area Settings
- Step 2: Alerts and Notifications

Back Next Cancel

### Step 1: Specify Motion Detection Area Settings

This section will allow you to enable or disable motion detection as well as control the sensitivity of your camera's ability to detect movement.

Enable Video Motion  Snapshot  Video Clip

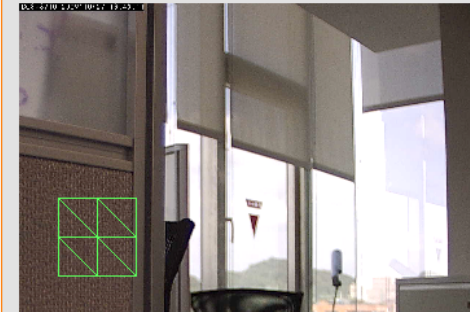

Back Next Cancel

### step 2: Motion Detection Schedule

This section allows you to specify the time and dates that your camera records motion. Please note that recorded camera footage will take up space on your hard drive. It is therefore recommended that you have sufficient disk space for Always function.

Sun  Mon  Tue  Wed  Thu  Fri  Sat

Time

Always

From 00 To 23 59

Back Next Cancel

### Step 3

This step allows you to specify how you will receive event notifications from your camera. You may choose not to receive notifications, or to receive notifications via e-mail or FTP.

Please enter the relevant information for your e-mail or FTP account.

Click **Next** to continue.

**Step 3: Alerts and Notification**

This final step allows you to specify how you receive notification of camera events. Choose between an email notification or alternatively you can setup an FTP Notification. You will need your email account settings or FTP details. If you are unsure of this information, please contact your ISP. Once you have entered this information, please click on the Next button.

Do not notify me  
 Email

Sender email address:   
 Recipient email address:   
 Server address:   
 User name:   
 Password:   
 Port:

FTP

Server address:   
 Port:   
 User name:   
 Password:   
 Remote folder name:

Back | Next | Cancel

### Step 4

You have completed the Motion Detection Wizard.

Please verify your settings and click **Apply** to save them.

**Step 4: Setup Complete**

You have completed your camera setup. Please click the Back button if you want to review or modify your settings or click on the Apply button to save and apply your settings.

Motion Detection : Enable  
 EVENT : Video Clip  
 Schedule Day : Sun , Mon , Tue , Wed , Thu , Fri , Sat ,  
 Schedule Time : Always  
 Alerts and Notification : Email

Back | Apply | Cancel

Please wait a few moments while the camera saves your settings and restarts.

**Step 4: Setup Complete**

You have completed your camera setup. Please click the Back button if you want to review or modify your settings or click on the Apply button to save and apply your settings.

Changes saved.IP Camera's network is restarting, please wait for 3 seconds ...

Back | Apply | Cancel

# Network Setup

Use this section to configure the network connections for your camera. All relevant information must be entered accurately.

**LAN Settings:** Settings for your local area network.

**DHCP:** Select this connection if you have a DHCP server running on your network and would like your camera to obtain an IP address automatically.

**Static IP Address:** You may obtain a static or fixed IP address and other network information from your network administrator for your camera. A static IP address may simplify access to your camera in the future.

**IP Address:** Enter the fixed IP address in this field.

**Subnet Mask:** This number is used to determine if the destination is in the same subnet. The default value is 255.255.255.0.

**Default Gateway:** The gateway used to forward frames to destinations in a different subnet. Invalid gateway settings may cause the failure of transmissions to a different subnet.

**Primary DNS:** The primary domain name server translates names to IP addresses.

**Secondary DNS:** The secondary DNS acts as a backup to the primary DNS.

**Enable UPnP:** Enabling this setting allows your camera to be configured as a UPnP device on your network.

**Enable UPnP Port Forwarding:** Enabling this setting allows the camera to add port forwarding entries into the router automatically on a UPnP capable network.



**Enable PPPoE:** Enable this setting if your network uses PPPoE.

**User Name:** The unique name of your account. You may obtain this information from your ISP.

**Password:** The password to your account. You may obtain this information from your ISP.

**HTTP Port:** The default port number is 80.

**Access Name for Stream 1~3:** The default name is video#.mjpg, where # is the number of the stream.

**HTTPS Port:** You may use a PC with a secure browser to connect to the HTTPS port of the camera. The default port number is 443.

**RTSP Port:** The port number that you use for RTSP streaming to mobile devices, such as mobile phones or PDAs. The default port number is 554. You may specify the address of a particular stream. For instance, live1.sdp can be accessed at `rtsp://x.x.x.x/video1.sdp` where the x.x.x.x represents the ip address of your camera.

**Maximum Upload/Download Bandwidth:** Specifying the maximum download/upload bandwidth for each socket can be useful when connecting your device to a busy or heavily loaded network. Entering a value of '0' indicates that the camera should not monitor bandwidth. Specifying other values will limit the camera's transfer speed to the specified number of Kilobytes per second.

**D-Link**

DCS-6815/6817/6818

LIVE VIDEO SETUP ADVANCED MAINTENANCE STATUS HELP

**NETWORK SETUP**

You can configure your LAN and Internet settings here.

Save Settings Don't Save Settings

**LAN SETTINGS**

DHCP  
 Static IP Client

IP address: 172.17.5.84  
Subnet mask: 255.255.255.0  
Default router: 172.17.5.254  
Primary DNS: 192.168.168.250  
Secondary DNS: 192.168.168.201

Enable UPnP presentation  
 Enable UPnP port forwarding

Forwarding Port: 8084  
Forwarding Status: UPnP forwarding is inactive

**PPPOE SETTINGS**

Enable  Disable

User Name: \_\_\_\_\_  
Password: \_\_\_\_\_  
Confirm password: \_\_\_\_\_  
PPPoE Status: \_\_\_\_\_

**HTTP**

HTTP port: 80  
Access name for stream1: video1.mjpg  
Access name for stream2: video2.mjpg  
Access name for stream3: video3.mjpg

**HTTPS**

HTTPS port: 443

**RTSP**

RTSP port: 554  
Access name for stream1: live1.sdp  
Access name for stream2: live2.sdp  
Access name for stream3: live3.sdp

**TRAFFIC**

Maximum Upload Bandwidth: 0 Kilo Bytes Per Second  
Maximum Download Bandwidth: 0 Kilo Bytes Per Second

Save Settings Don't Save Settings

**SECURITY**

**Helpful Hints:**

Select DHCP Connection if you are running a DHCP server on your network and would like an IP address assigned to your IP camera automatically.

Enabling UPnP settings will allow you to configure your IP camera as an UPnP device in the network.

PPPoE Setting - If you use the IP camera to connect directly to the Internet, you will need to enter the username and password, which were given to you when you set up your account with your Internet Service Provider. If the camera is behind a router or a gateway, you do not need to configure this setting.

HTTP Port is the port you allocate in order to connect to the IP camera via a standard web browser.

HTTPS Port is a IP camera connects it with a PC via a secure web browser.

RTSP Port is the port you allocate in order to connect to a IP camera by using streaming mobile devices, such as a mobile phone or PDA.

Traffic - Specifying the maximum download/upload bandwidth for each socket is useful when connecting your device to a busy or heavily loaded network.

\*The value '0' means it will not monitor any traffic.

# Dynamic DNS

DDNS (Dynamic Domain Name Server) will hold a DNS host name and synchronize the camera's public IP address when it has been modified. A user name and password are required when using the DDNS service.

**Enable DDNS:** Select this checkbox to enable the DDNS function.

**Server Address:** Select your Dynamic DNS provider from the drop-down menu or enter the server address manually.

**Host Name:** Enter the host name of the DDNS server.

**User Name:** Enter your user name or e-mail used to connect to the DDNS.

**Password:** Enter your password used to connect to the DDNS server.

**Timeout:** Enter DNS Timeout values.

**Status:** Indicates the connection status, which is automatically determined by the system.

Product: DCS-6818 B1 Firmware Version : 0.04

**D-Link**

DCS-6818 B1 // LIVE VIDEO SETUP ADVANCED MAINTENANCE STATUS HELP

**DYNAMIC DNS**

The Dynamic DNS feature allows you to use a domain name that you have purchased (www.yourdomain.com) to access your IP camera with a dynamically assigned IP address. Most broadband Internet service providers assign dynamic (changing) IP addresses. By using a DDNS service, you can enter your domain name to connect to your IP camera no matter what your IP address is.

[Sign up for D-Link's Free DDNS service at www.DLinkDDNS.com.](http://www.dlinkdns.com)

Save Settings Don't Save Settings

**DYNAMIC DNS SETTING**

Enable DDNS

Server Address  <<

Host Name

User Name

Password

Verify Password

Timeout  (hours)

Status Inactive

Save Settings Don't Save Settings

**Helpful Hints...**

Dynamic DNS is useful if you have a DSL or Cable service provider that changes your modem ip address periodically. This will allow you to assign a website domain name to your IP camera instead of connecting through an IP address.

# Image Setup

Adjustments to these settings will affect the amount of network resources that the camera will use.

## Enable Privacy Mask

**Mask:** Select this checkbox to enable the privacy mask.

**Transparency:** Turning transparency on allows you to see through the privacy mask area.

**Color:** This is the color that will be displayed over the masked area.

**Number:** Select which mask area you would like to set. You may set up to 16 different masked areas.

**H Size:** Specifies the horizontal length of the masked area in pixels.

**V Size:** Specifies the vertical length of the masked area in pixels.

The screenshot displays the D-Link camera's web interface. At the top, the 'D-Link' logo is visible. Below it, a navigation bar includes 'LIVE VIDEO', 'SETUP', 'ADVANCED', 'MAINTENANCE', 'STATUS', and 'HELP'. The 'SETUP' tab is active, showing the 'IMAGE SETUP' page. A message states: 'Changes to your IP camera settings are made immediately.' The 'LIVE VIDEO' section features a video feed of a building entrance with a black privacy mask applied to a portion of the image. To the right of the video feed, there are controls for 'Enable Privacy Mask' (checkbox), 'Transparency' (radio buttons for ON/OFF), 'Color' (dropdown menu set to 'black'), 'Number' (dropdown menu set to '1'), 'H Size' (input field '10' with range '[1~80]'), and 'V Size' (input field '2' with range '[1~60]'). Below these are 'Add' and 'Clear' buttons. The 'IMAGE SETTINGS' section contains various camera parameters: BLC (radio buttons ON/OFF), WDR (radio buttons ON/OFF), White Balance (dropdown menu 'Auto'), Flip (dropdown menu 'M.E. Flip'), Inverse (radio buttons ON/OFF), AE Mode (dropdown menu 'Auto'), Shutter (dropdown menu '1/60'), Gain (dropdown menu '2'), Brightness (dropdown menu '128'), Contrast (dropdown menu '128'), Saturation (dropdown menu '128'), Sharpness (dropdown menu '8'), and Expcomp (dropdown menu '8'). A 'Reset Default' button is located at the bottom of this section. The 'Helpful Hints' sidebar on the right provides definitions for Privacy Mask, BLC, WDR, White Balance, ATW, Inverse, AE Mode, and Shutter.

**BLC:** This function will enable backlight compensation, if the object is in front of strong backlight.

**WDR:** Wide Dynamic Range - This function allows the camera to be installed in high contrast and backlit environments.

**White Balance:** It is the process of removing unrealistic color casts, so that an object appears white in person that is correctly rendered as white on the screen.

**Flip:** You may choose Mechanical (M.E.) Flip or Image (digital) Flip. Mechanical Flip uses the PTZ mechanism, while Image Flip uses the digital system to flip the image.

**Inverse:** Turn this option on to invert the image.

**AE Mode:** This feature automatically sets the aperture and shutter speed, if Auto is selected. If Manual is selected, you may specify the shutter speed and gain. You may also select Shutter Priority and specify the shutter speed.

**Brightness:** Adjust this control to compensate for brightly backlit camera images.

**Contrast:** Adjust this control to increase or decrease the contrast of the camera image.

**Saturation:** Adjust this control to increase/decrease the color saturation of the picture.

**Sharpness:** This function controls the amount of sharpening applied to the image.

**Excomp:** Exposure compensation can be used to adjust exposure.

**Reset to Defaults:** Click this button to reset these settings to their defaults.

**D-Link**

DCS-6818 B1 // LIVE VIDEO SETUP ADVANCED MAINTENANCE STATUS HELP

Setup Wizard  
Network Setup  
Dynamic DNS  
Image Setup  
Audio and Video  
PTZ Setup  
Preset  
Motion Detection  
Time and Date  
Event Setup  
SD Card  
Logout

**IMAGE SETUP**  
Changes to your IP camera settings are made immediately.

**LIVE VIDEO**  
10/25/2011 10:55:00  
DCS-6818 B1  
TX

Enable Privacy Mask  
Transparency  ON  OFF  
Color **black**  
Number **1**  
H Size **10** [1~80]  
V Size **2** [1~60]  
**Add Clear**

**IMAGE SETTINGS**

BLC  ON  OFF  
WDR  ON  OFF  
White Balance **Auto**  
Flip **M.E. Flip**  
Inverse  ON  OFF  
AE Mode **Auto** Shutter **1/60** Gain **2**  
Brightness **128**  
Contrast **128**  
Saturation **128**  
Sharpness **8**  
Excomp **8**  
**Reset Default**

**Helpful Hints...**  
**Privacy Mask** - The Privacy Mask function aims to avoid any intrusive monitoring.  
**BLC** - This function will enable the back light compensation, if the object is in front of strong backlight.  
**WDR** - This function enables the camera to be widely applied in high contrast environments such as lobby entrances, parking lots, ATMs, loading areas, and much more.  
**White Balance** - It is the process of removing unrealistic color casts, so that object appears white in person that is rendered white in your photo.  
**ATW** - Auto Tracing White Balance. The Dome Camera takes out the signals in a screen in the range from 2000K to 10000K.  
**Inverse** - To inverse image.  
**Inverse** - To inverse image.  
**AE Mode** - This key feature automatically sets the aperture and shutter speed, if selects Auto.  
**Shutter** - This function is to adjust the shutter speed.  
**Gain** - This function is to

# Audio and Video

You may configure 3 video profiles with different settings for your camera. Hence, you may set up different profiles for your computer and mobile display. In addition, you may also configure the two-way audio settings for your camera.

**Mode:** You may select H.264, MPEG4 or MJPEG encoding.

**Frame Size:** This option allows the user to choose the video resolution of the camera. The options include NTSC: D1 (720x480), CIF (352x240), QCIF (176x120) and PAL: D1 (720x576), CIF (352x288), QCIF (176x144).

**Maximum Frame Rate:** A higher frame rate provides smoother motion for video. Lower frame rates will result in stuttering.

**Video Quality:** Select the number of frames to be captured per second. 30fps is the highest video quality for this device.

**Constant Bit Rate:** This limits the maximal refresh frame rate, which can be combined with the “Fixed quality” to optimize the bandwidth utilization and video quality. To set the bandwidth utilization regardless of the video quality, choose “Constant bit rate” and select the desired bandwidth.

**Fixed Quality:** Select the image quality level of the video. You may choose **Standard**, **Good**, or **Excellent**.

**Audio In Off:** Select this option to disable Audio In.

**Audio In Gain Level:** Select 20 or 26 dB to make the audio louder.

**Audio Out Off:** Select this option to disable Audio Out.

**Audio Out Volume Level:** Choose a level between 1 and 10.

The screenshot shows the D-Link camera web interface. The top navigation bar includes 'LIVE VIDEO', 'SETUP', 'ADVANCED', 'MAINTENANCE', 'STATUS', and 'HELP'. The 'SETUP' tab is selected, and the 'AUDIO AND VIDEO' sub-tab is active. The page title is 'AUDIO AND VIDEO'. Below the title, there is a brief description: 'This section allows you to configure the sound and video of your camera. You can configure different settings depending on whether you are viewing content from a PC or a Mobile Phone / PDA.' There are 'Save Settings' and 'Don't Save Settings' buttons.

The configuration is organized into three sections: VIDEO PROFILE 1, VIDEO PROFILE 2, and VIDEO PROFILE 3. Each profile has the following settings:

- Mode:** H.264 (Profile 1), JPEG (Profile 2), MPEG4 (Profile 3)
- Frame size:** 720x480 (Profile 1), 720x480 (Profile 2), 352x240 (Profile 3)
- Maximum frame rate:** 30 (Profile 1), 30 (Profile 2), 30 (Profile 3)
- Video quality:** Constant bit rate (Profile 1), Excellent (Profile 1), Excellent (Profile 2), Excellent (Profile 3)
- Constant bit rate:** 2M (Profile 1)
- Fixed quality:** Excellent (Profile 1)

Below the video profiles is the **AUDIO SETTINGS** section:

- Audio in off
- Audio in gain level: 20dB
- Audio out off
- Audio out volume level: 10

There are 'Save Settings' and 'Don't Save Settings' buttons at the bottom of the audio settings section.

On the right side of the page, there is a 'Helpful Hints...' section with several paragraphs of text providing additional information and tips for configuration.

# PTZ Setup

This page allows you to configure the pan/tilt/zoom settings for the camera. Changes to settings on this page take place immediately.

**Auto Pan:** Auto Pan scans an area horizontally from left to right or right to left. Up to 4 Auto Pan paths may be defined. Select the button next to the path that you would like to set. Use the navigation pad to move the camera view to the desired start point and click **Set Start Point**. Move the camera view to the desired end point and click **Set End Point**. You may also specify the pan direction and speed. Click the **Test** button to view the path that you have just defined. Click **Stop** to end the test.

**Cruise:** A Cruise path is a stored route defined through manual adjustment of pan, tilt, and zoom. Up to 4 Cruise paths may be defined. Select the button next to the path that you would like to set. Click **Record Start** to begin recording a path. Use the navigation pad or mouse to define a path within the live video window. Click **Record End** when you are done defining the path. Click the **Test** button to view the path that you have just defined. Click **Stop** to end the test.

**Home:** You may turn on the home function and specify the PTZ behavior.

**Digital Zoom:** You may turn digital zoom on or off.

**Freeze:** If this option is turned on, the image will freeze at the end of the predefined path and return to the starting point.

The screenshot displays the D-Link PTZ Setup web interface. The top navigation bar includes tabs for LIVE VIDEO, SETUP, ADVANCED, MAINTENANCE, STATUS, and HELP. The left sidebar lists various setup options, with PTZ Setup selected. The main content area is titled 'PTZ SETUP' and contains a 'LIVE VIDEO' window showing a camera view of a building entrance. To the right of the live video is a navigation pad and controls for Pan Speed (16) and Tilt Speed (16). Below the live video are sections for 'AUTO PAN' and 'CRUISE', each with a path selector and buttons for 'Set Start Point', 'Set End Point', 'Record Start', 'Record End', 'Test', and 'Stop'. The 'MISCELLANEOUS' section includes options for Home (ON/OFF), Digital Zoom (ON/OFF), Freeze (ON/OFF), Auto Calibration (ON/OFF), 2DNR (ON/OFF), 3DNR (ON/OFF), and Tilt Angle (Min: 10, Max: 80). A 'SECURITY' banner is visible at the bottom of the interface.

**Auto Calibration:** Turning this option on will automatically calibrate the camera when needed to ensure that the

**2DNR:** This option turns on 2D noise reduction which may improve picture quality.

**3DNR:** This option turns on 3D noise reduction which may further improve image quality.

**Tilt Angle:** The option allows you to adjust the minimum and maximum tilt angle of the camera.

The screenshot shows the D-Link camera configuration web interface. The top navigation bar includes 'LIVE VIDEO', 'SETUP', 'ADVANCED', 'MAINTENANCE', 'STATUS', and 'HELP'. The left sidebar lists various setup options, with 'PTZ Setup' selected. The main content area is titled 'PTZ SETUP' and contains several sections:

- PTZ SETUP:** A message states 'Changes to your IP camera settings are made immediately.'
- LIVE VIDEO:** Displays a live video feed of a building entrance. To the right is a directional pad and speed controls: 'Pan Speed' and 'Tilt Speed', both set to '16'.
- AUTO PAN:** Includes a 'Path' dropdown set to '1', a 'Direction' dropdown set to 'Right', and a 'Speed' dropdown set to '1'. Buttons for 'Set Start Point', 'Set End Point', 'Test', and 'Stop' are present.
- CRUISE:** Includes a 'Path' dropdown set to '1' and buttons for 'Record Start', 'Record End', 'Test', and 'Stop'.
- MISCELLANEOUS:** Contains several settings:
  - 'Home' is set to 'ON'.
  - 'Mode' is set to 'Preset', with 'Path' set to '1' and 'Delay' set to '1'. A 'Modify' button is next to it.
  - 'Digital Zoom' is set to 'OFF'.
  - 'Freeze' is set to 'OFF'.
  - 'Auto Calibration' is set to 'ON'.
  - '2DNR' is set to 'ON'.
  - '3DNR' is set to 'OFF'.
  - 'Tilt Angle' has 'Min' set to '10' and 'Max' set to '80'.

On the right side, there is a 'Helpful Hints...' section with text explaining 'Auto Pan', 'Cruise', and 'Home Function'.



# Preset

This page allows you to define presets and a preset sequence for the camera image.

**Preset:** Use the navigation pad or mouse to target a specific view in the live video window. You may adjust the pan and tilt speed if needed.

## Create a New Preset

1. Select the page number, between 1 and 26.
2. Select an unused preset number from the preset list.
3. Choose a name for the preset.
4. Click **Add**.

## Remove a Preset

1. Select the page number.
2. Select the preset from the preset list.
3. Click **Remove**.

## Rename a Preset

1. Select the page number.
2. Select the preset from the preset list.
3. Enter a new name for the preset, overwriting the old name.
4. Click **Rename**.

## Set a Preset as the Home Position

1. Select the page number.
2. Select the preset from the preset list.
3. Click **Set**.

## Reset the Home Position to Default

1. Click **Default**.

The screenshot shows the D-Link camera web interface. The top navigation bar includes 'LIVE VIDEO', 'SETUP', 'ADVANCED', 'MAINTENANCE', 'STATUS', and 'HELP'. The left sidebar lists various setup options, with 'Preset' selected. The main content area is titled 'PTZ PRESET' and contains the following sections:

- LIVE VIDEO:** A video window showing a camera view of a building entrance. To the right is a PTZ control pad with a central '+' button and four directional arrows. Below the pad are 'Pan Speed' and 'Tilt Speed' dropdown menus, both set to '16'.
- PRESET:** A section for managing individual presets. It includes a 'Page No' dropdown (set to '1'), a 'Preset' dropdown (set to '--Preset No--'), a 'Name' input field, and buttons for 'Add', 'Rename', 'Goto', and 'Remove'. Below this is a 'Choose' dropdown (set to '1-5555(H)') with the text 'as Home position.' and 'Set' and 'Default' buttons.
- PRESET SEQUENCE:** A table for defining a sequence of presets. It includes a 'Path' dropdown (set to '1') and buttons for 'Goto', 'Stop', 'Prev Page', and 'Next Page'. The table has columns for 'No.', 'Preset', 'Dwell time', and 'Speed'.
 

No.	Preset	Dwell time	Speed
1	1-5555(H)	5	5
2	2-7777	5	5
3	--Preset List--		

Helpful Hints on the right side of the page state: 'Preset - Using the Pan, Tilt and Zoom (PTZ) controls, move the camera view to the required position.' and 'Preset sequence - Sequence is an automated series of camera movements from one preset position to another. A guard tour can be set up to display the video streams from different preset positions in a pre-determined order, and for configurable time periods.'



**Preset Sequence:** Sequence is an automated series of camera movements from one preset position to another. A sequence can be set up to display the video streams from different preset positions in a pre-determined order, and for configurable time periods.

Before creating a sequence, you must first define some presets. (Please see the previous page.)

### Define a Preset Sequence

1. Specify a path number to use.
2. Specify up to 64 point numbers using the **Prev Page** and **Next Page** buttons to navigate between the sequence preset numbers:
  - a. Select a preset point from the Preset List.
  - b. Specify the Dwell Time.
  - c. Specify the Camera Speed.
3. Repeat steps a,b, and c, for up to 64 points.
4. Click **Save** to save your preset sequence.

The screenshot shows the D-Link web interface for configuring PTZ Presets. The interface is organized into several sections:

- PTZ PRESET:** This section allows you to customize PTZ monitoring tracks. It features a live video feed of a building entrance and a PTZ control panel with a directional pad and zoom controls. Below the video, there are dropdown menus for Pan Speed (set to 16) and Tilt Speed (set to 16).
- PRESET:** This section includes a 'Page No' dropdown (set to 1), a 'Preset' dropdown (set to --Preset No--), a 'Name' field, and buttons for 'Add', 'Rename', 'Goto', and 'Remove'. Below this, there is a 'Preset List' dropdown (set to --Preset List--), a 'Choose' dropdown (set to 1-5555(H)), and buttons for 'Set' and 'Default'.
- PRESET SEQUENCE:** This section includes a 'Path' dropdown (set to 1), 'Goto' and 'Stop' buttons, and 'Prev Page' and 'Next Page' buttons. Below this is a table for defining the sequence points:

No.	Preset	Dwell time [1=127sec]	Speed [1=15]
1	1-5555(H)	5	5
2	2-7777	5	5
3	--Preset List--		

The right sidebar contains 'Helpful Hints...' which explains the Preset and Preset sequence concepts.

# Motion Detection

This section allows you to enable and configure motion detection areas.

**Enable Video Motion:** Select this box to enable the motion detection feature of your camera.

**Sensitivity:** Specifies the measurable difference between two sequential images that would indicate motion. Please enter a value between 0 and 100.

**Percentage:** Specifies the amount of motion in the window being monitored that is required to initiate an alert. If this is set to 100%, motion is detected within the whole window will trigger a snapshot.

**Draw Motion Area:** Draw the motion detection area by dragging your mouse in the window (indicated by the red square).

**Erase Motion Area:** To erase a motion detection area, simply click on the red square that you wish to remove.

Right clicking on the camera image brings up the following menu options:

**Select All:** Draws a motion detection area over the entire screen.

**Clear All:** Clears any motion detection areas that have been drawn.

**Restore:** Restores the previously specified motion detection areas.

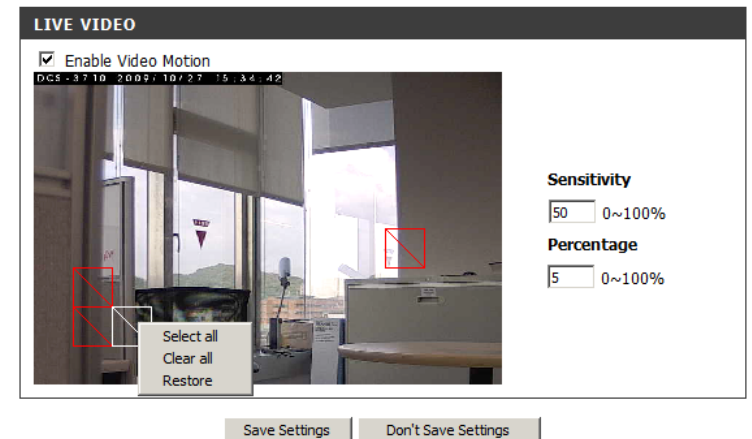
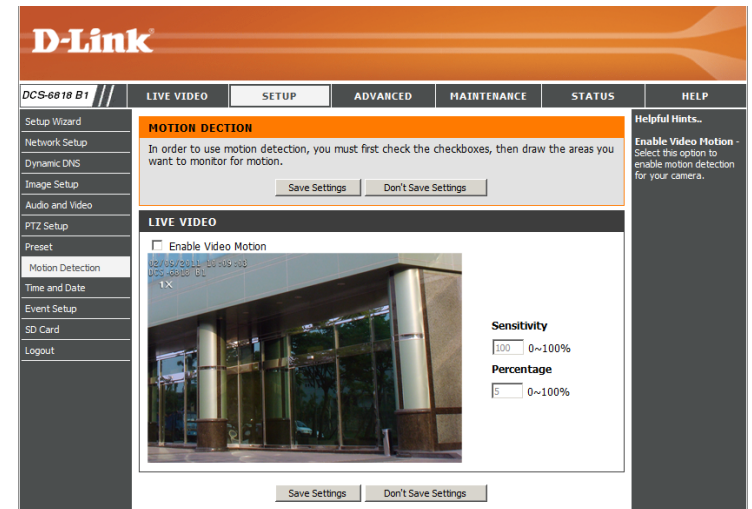

# Time and Date

This section allows you to automatically or manually configure, update, and maintain the internal system clock for your camera.

**Time Zone:** Select your time zone from the drop-down menu.

## Enable Daylight

**Saving:** Select this to enable Daylight Saving Time.

**Auto Daylight Saving:** Select this option to allow your camera to configure the Daylight Saving settings automatically.

**Set Date and Time Manually:** Selecting this option allows you to configure the Daylight Saving date and time manually.

**Offset:** Sets the amount of time to be added or removed when Daylight Saving is enabled.

**Synchronize with NTP Server:** Enable this feature to obtain time automatically from an NTP server.

**NTP Server:** Network Time Protocol (NTP) synchronizes the DCS-6815/6817/6818 with an Internet time server. Choose the one that is closest to your location.

## Set the Date and

**Time Manually:** This option allows you to set the time and date manually.

## Copy Your Computer's Time

**Settings:** This will synchronize the time information from your PC.

**D-Link**

DCS-6818 B1 // LIVE VIDEO SETUP ADVANCED MAINTENANCE STATUS HELP

**TIME AND DATE**

You can set the current time for the IP camera.

Save Settings Don't Save Settings

**TIME CONFIGURATION**

Time Zone (GMT+08:00) Taipei

Enable Daylight Saving

Auto Daylight Saving

Set date and time manually

Offset +2:00

Month Week Day of week Hour Minutes

Start time 5 1 Sunday 0 00

End time 10 1 Sunday 0 00

**AUTOMATIC TIME CONFIGURATION**

Synchronize with NTP Server

NTP Server ntp.dlink.com.tw << Select NTP Server

**SET DATE AND TIME MANUALLY**

Set date and time manually

Year 2011 Month 2 Day 9

Hour 10 Minute 10 Second 20

Copy Your Computer's Time Settings

Save Settings Don't Save Settings

**Helpful Hints...**

Good timekeeping is important for accurate logs and scheduled firewall rules.

**Time Zone:** Select your time zone from the drop-down menu.

**Enable Daylight Saving:** Select this to enable the daylight saving time.

**Auto Daylight Saving:** When you select to the clock is automatically adjusted according to the daylight saving time of the selected time zone.

**Offset:** Select the time offset, if your location observes daylight saving time.

**Synchronize with NTP Server:** With the option selected, the camera will synchronize the time settings with the NTP server over the Internet whenever the camera starts up. If the timeserver cannot be reached, no time settings will be applied.

**NTP Server:** Network Time Protocol (NTP) synchronizes the IP camera with an Internet time server. Choose the one that is closest to your location.

Copy Your

# Event Setup

The Event Setup page includes four different sections.

- Event
- Server
- Media
- Recording

1. To add a new item - "event, server or media," click **Add**. A screen will appear and allow you to update the fields accordingly.
2. To delete the selected item from the drop-down menu of event, server or media, click **Delete**.
3. Click on the item name to pop up a window for modifying.

**Note:** You can add up to four events, five servers, and five media fields.

**D-Link**

DCS-6818 B1 // LIVE VIDEO SETUP ADVANCED MAINTENANCE STATUS HELP

**EVENT SETUP**

There are four sections in Event Setup page. They are event, server, media and recording. Click Add to pop a window to add a new item of event, server, media or recording. Click Delete to delete the selected item from event, server, media or recording. Click on the item name to pop a window to edit it. There can be at most three events and two recording. There can be at most five server and five media configurations.

**SERVER**

Name	Type	Address/Location
sd	sd card	

Add | sd | Delete

**MEDIA**

Media freespace: 6700KB

Name	Type
snap	snapshot

Add | snap | Delete

**EVENT**

Name	Status	Sun	Mon	Tue	Wed	Thu	Fri	Sat	Time	Trigger
d1	ON	V	V	V	V	V	V	V	00:00~23:59	digital
d2	ON	V	V	V	V	V	V	V	00:00~23:59	motion

Add | d1 | Delete

**RECORDING**

Name	Status	Sun	Mon	Tue	Wed	Thu	Fri	Sat	Time	Source	Destination
ro	ON	V	V	V	V	V	V	V	00:00~23:59	Profile 1	SD

Add | ro | Delete

**Helpful Hints..**

Suggest setting server and media first before setting event. The servers and media which selected in event list are not be able to modify or delete. Please remove them first from the event if you want to delete or modify them. Recommend using different media in different event to make use all media be produced and received correctly. If using the same media in different events and the events trigger almost simultaneously, the servers in the second triggered event will not receive any media; there would be only notifications.

# Application

In a typical application, when motion is detected, the DCS-6815/6817/6818 Network Camera sends images to a FTP server or via e-mail as notifications. As shown in the illustration below, an event can be triggered by many sources, such as motion detection or external digital input devices. When an event is triggered, a specified action will be performed. You can configure the Network Camera to send snapshots or videos to your e-mail address or FTP site.

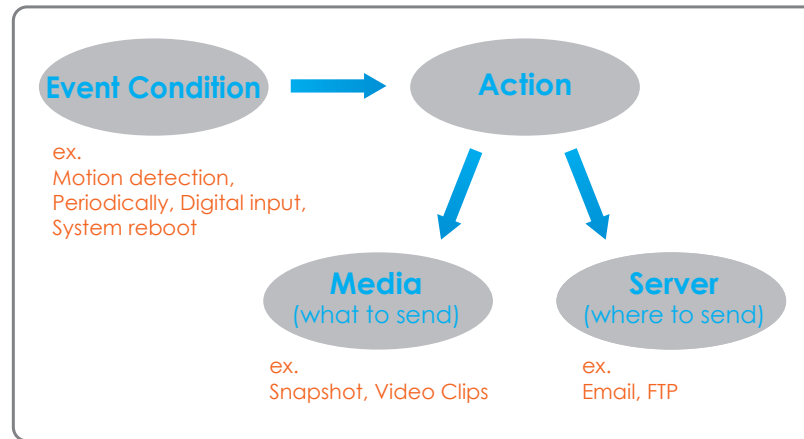

To start plotting an event, it is suggested to configure server and media columns first so that the Network Camera will know what action shall be performed when a trigger is activated.

# Add Server

Configure up to 5 servers to store media.

**Server Name:** Enter the unique name of your server.

**E-mail:** Enter the configuration for the target e-mail server account.

**FTP:** Enter the configuration for the target FTP server account.

**Network Storage:** Specify a network storage device. Only one network storage device is supported.

**D-Link**

DCS-6818 B1 // LIVE VIDEO SETUP ADVANCED MAINTENANCE STATUS HELP

Setup Wizard  
Network Setup  
Dynamic DNS  
Image Setup  
Audio and Video  
Motion Detection  
Time and Date  
Event Setup  
SD Card  
Auto Focus  
Logout

**SERVER**

You can set at most 5 different servers here for different event.

test Save Settings Don't Save Settings

**SERVER TYPE**

Server Name:

Email

Sender email address

Recipient email address

Server address

User name

Password

Port

This server requires a secure connection (StartTLS)

FTP

Server address

Port

User name

Password

Remote folder name

Passive mode

Network storage

Network storage location

(for example:\my\_nas\disk\folder)

Workgroup

User name

Password

Primary WINS server

**Helpful hints...**

**"Server name"** The unique name for server. There are four kinds of servers supported. They are email server, FTP server, HTTP server and network storage.

**Email server:**  
"Sender email address" The email address of the sender.  
"Recipient email address" The email address of the recipient.

**FTP server:**  
"Remote folder name" Granted folder on the external FTP server. The string must conform to that of the external FTP server. Some FTP servers cannot accept preceding slash symbol before the path without virtual path mapping. Refer to the instructions for the external FTP server for details. The folder privilege must be open for upload.  
"Passive Mode" Check it to enable passive mode in transmission.

**Network storage:** Only one network storage is supported.

**"Network storage location"** The path to upload the media.  
"Workgroup" The workgroup for network storage.

**SD card:**  
Use the SD card for recording media.

# Add Media

There are three types of media, **Snapshot**, **Video Clip** and **System Log**.

**Media Name:** Enter a unique name for media.

**Snapshot:** Select this option to enable snapshots.

**Source:** The stream source: **Profile 1**, **Profile 2** or **Profile 3**.

**Send pre-event image(s) [0~4]:** The number of pre-event images.

**Send post-event image(s) [0~7]:** The number of post-event images.

**File name prefix:** The prefix name will be added on the file name.

**Add date and time suffix to file name:** Check it to add timing information as file name suffix.

**Video clip:** Select this option to enable video clips.

**Source:** The source of the profile: **profile1**, **profile2**, or **profile3**.

**Pre-event recording:** The interval of pre-event recording in seconds.

**Maximum duration:** The maximal recording file duration in seconds.

**Maximum file size:** The maximal file size would be generated.

**File name prefix:** The prefix name will be added on the file name of the video clip.

**System log:** Select this option to save events to the camera system log.

**D-Link**

DCS-6818 B1 // LIVE VIDEO SETUP ADVANCED MAINTENANCE STATUS HELP

**MEDIA**

You can set at most 5 different media here for different event.

Save Settings Don't Save Settings

**MEDIA TYPE**

Media name:

snapshot

Source:

Send  pre-event image(s) [0~4]

Send  post-event image(s) [0~7]

File Name Prefix:

Add date and time suffix to file name

Video Clip

Source:

Pre-event recording:  Second(s) [0~4]

Maximum duration:  Second(s) [1~100]

Maximum file size:  Kbytes [100~3000]

File Name Prefix:

System log

Save Settings Don't Save Settings

**Helpful Hints.**

**"Media name"** The unique name for media. There are three kinds of media. They are snapshot, video clip and system log.

**Snapshot:**

**"Source"** The source of profile, profile1 or profile2.

**"Send Pre-event images"** The number of pre-event images.

**"Send Post-event images"** The number of post-event images.

**"File name prefix"** The prefix name will be added on the file name of the snapshot images.

**"Add date and time suffix to file name"** Check it to add timing information as file name suffix.

**Video clip:**

**"Source"** The source of profile, profile1 or profile2.

**"Pre-event recording"** The interval of pre-event recording in seconds There are two limitations for video clip file.

**"Maximum duration"** The maximal recording file duration in seconds.

**"Maximum file size"**

### Send post-event image (s) [0~7]

Specify to capture the number of images after a trigger is activated. A maximum of seven images can be generated.

For example:

If both the Send pre-event images and Send post-event images are set to four, a total of 9 images are generated after a trigger is activated.

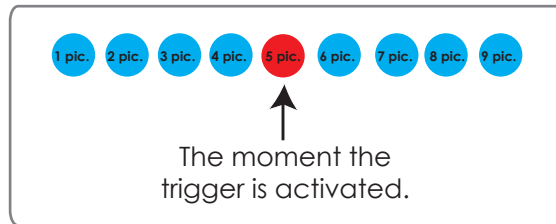

Add a date and time suffix to the file name

Select this option to add a date and time to the file name suffix.

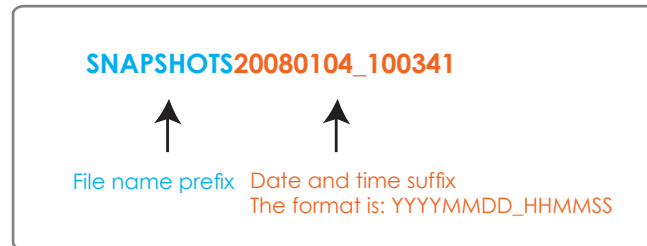

### Maximum duration

Specify the maximal recording duration in seconds. You can set up to ten seconds.

For example:

If the Pre-event recording is set to five seconds and the Maximum duration is set to ten seconds, the Network Camera continues to record for another four seconds after a trigger is activated.



for another four seconds after a trigger is activated.

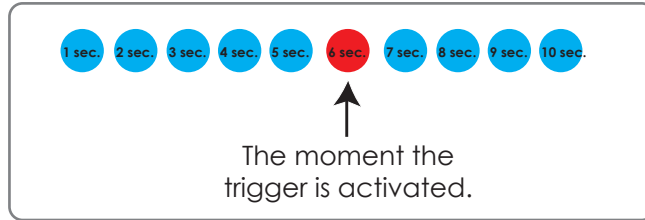

### File name prefix

Enter the text that will be added at the beginning of the file name.

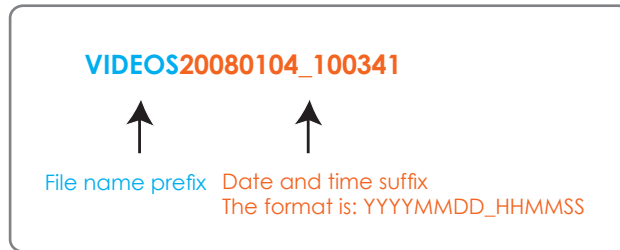

# Add Event

Create and schedule up to three events with their own settings here.

**Event name:** Enter a name for the event.

**Enable this event:** Select this box to activate this event.

**Priority:** Set the priority for this event. The event with higher priority will be executed first.

**Delay:** Select the delay time before checking the next event. It is being used for both events of motion detection and digital input trigger.

**Trigger:** Specify the input type that triggers the event.

**Video Motion Detection:** Motion is detected during live video monitoring. Select the windows that need to be monitored.

**Periodic:** The event is triggered in specified intervals. The trigger interval unit is in minutes.

**Digital Input:** The external digital input trigger input to the camera.

**System Boot:** Triggers an event when the system boots up.

**Network Lost:** Triggers an event when the network is lost.

**Time:** Select **Always** or enter the time interval.

**Trigger D/O:** Select to trigger the digital output for a specific number of seconds when an event occurs.

**D-Link**

DCS-6818 B1 // LIVE VIDEO SETUP ADVANCED MAINTENANCE STATUS HELP

Setup Wizard  
Network Setup  
Dynamic DNS  
Image Setup  
Audio and Video  
Motion Detection  
Time and Date  
Event Setup  
SD Card  
Auto Focus  
Logout

**EVENT**

You can set at most 3 events like motion detection or digital input trigger here and arrange the detection schedule at the same time.

Save Settings Don't Save Settings

**EVENT**

Event name:

Enable this event

Priority:

Delay for  seconds before detecting next event [For motion detection and digital input]

**TRIGGER**

Video motion detection

Periodic  
Trigger every  minutes

Digital input

System boot

Network lost

**EVENT SCHEDULE**

Sun  Mon  Tue  Wed  Thu  Fri  Sat

**Time**

Always

From   To

**ACTION**

Trigger D/O for  seconds

Save Settings Don't Save Settings

**Helpful Hints...**

**Priority:** The event with higher priority will be executed first.

**Delay second(s) before detecting next event:** The delay to check next event. It is used in motion detection and digital input trigger type.

There are four kinds of trigger supported.

**Video motion detection:** Select the windows which need to be monitored.

**Periodic:** The event is triggered in specified intervals. The unit of trigger interval is minute.

**Digital input:** The event is triggered when the DI status changed by external device.

**System boot:** The event is triggered when the system boot up.

**Network lost:** The event is triggered when the network service is not available or disconnection.

**Sun ~ Sat:** Select the days of the week to perform the event.

**Time:** show "Always" or input the time interval.

The default action are triggering D/O and storing media on SD card. If there are servers configured, the user can

# Recording

Here you can configure and schedule the recording settings.

## Recording entry

**name:** The unique name of the entry.

## Enable this

**recording:** Select this to enable the recording function.

**Priority:** Set the priority for this entry. The entry with a higher priority value will be executed first.

**Source:** The source of the stream.

## Recording

**schedule:** Scheduling the recording entry.

**Recording settings:** Configuring the setting for the recording.

**Destination:** Select the folder where the recording file will be stored.

**Total cycling recording size:** Please input a volume size between 1MB and 200GB for recording space. The recording data will replace the oldest record when the total recording size exceeds this value. For example, if each recording file is 6MB, and the total cyclic recording size is 600MB, then the camera will record 100 files in the specified location (folder) and then will delete the oldest file and create new file for cyclic recording.

Please note that if there is not enough free space, the recording will stop. Before you set up this option please make sure that sufficient free space is available. It is better to not save other files in the same folder as recordings.

## Size of each file for

**recording:** File size for each recording file. You may input the value in the range of 200-5000.

**File Name Prefix:** The prefix name will be added on the file name of the recording file(s).

**D-Link**

DCS-6818 B1 // LIVE VIDEO SETUP ADVANCED MAINTENANCE STATUS HELP

**RECORDING**

You can setup schedule recording to network storage with your specify week day and time period.

Save Settings Don't Save Settings

**RECORDING**

Recording entry name:

Enable this recording

Priority: [normal]

Source: [Profile 1]

**RECORDING SCHEDULE**

Sun  Mon  Tue  Wed  Thu  Fri  Sat

Time

Always

From [00]  [00]  To [23]  [59]

**RECORDING SETTINGS**

Destination [Server 1]

Total cycling recording size: [1000]  Kbytes [1000~200000000]

Size of each file for recording: [200]  Kbytes [200~5000]

File Name Prefix:

Save Settings Don't Save Settings

**Helpful Hints..**

**Recording :** Enable this option if you want to upload the recording to a shared folder on the network.

**Recording schedule :** Select the day(s) according to when you want the camera to make a video clip.

**Always :** This enables the camera to make video clips continuously.

**From :** The time range specified for the video clip.

**Total cycling recording size :** Please input the network path of your network storage, it will be: \\DNS(IPCamRecord). If the network storage need authentication, please enter your user name and password here.

**Note:** Please Format CF card before use. The entire data in the CF card will be erased after formatting.

**Note:** Before you unplug the SD card from the slot, please select "Remove SD card" to ensure that your data is secure.

# Advanced

## DI and DO (Digital Input/Output)

The camera provides eight alarm inputs and one alarm output to connect alarm devices. With this function, the camera can cooperate with alarm system to catch event images.

**No. # DI Type: Normal Open** is for digital input that is activated when the circuit is closed.

**Normal Close** is for digital input that is activated when the circuit is opened.

**For example:** Connect the Alarm input terminal to ALM GND to activate [NC] or floating (unconnected) [NO] to deactivate

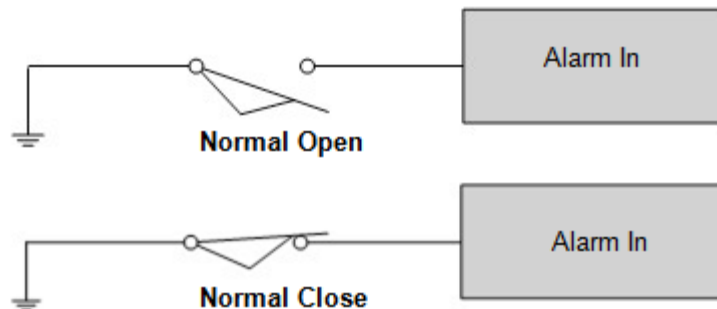

**D-Link**

DCS-6818 B1 // LIVE VIDEO SETUP ADVANCED MAINTENANCE STATUS HELP

DI and DO

ICR

HTTPS

Access List

Logout

**DI AND DO**

The I/O connector provides the physical interface for digital output (DO) and digital input (DI) that is used for connecting a diversity of external alarm devices such as IR-Sensors and alarm relays.

The digital input is used for connecting external alarm devices and once triggered images will be taken and e-mailed.

Save Settings Don't Save Settings

**DI AND DO**

Digital Input 1: The active state is  ; the current state detected is **Normal Open**

Digital Input 2: The active state is  ; the current state detected is **Normal Open**

Digital Input 3: The active state is  ; the current state detected is **Normal Open**

Digital Input 4: The active state is  ; the current state detected is **Normal Open**

Digital Input 5: The active state is  ; the current state detected is **Normal Open**

Digital Input 6: The active state is  ; the current state detected is **Normal Open**

Digital Input 7: The active state is  ; the current state detected is **Normal Open**

Digital Input 8: The active state is  ; the current state detected is **Normal Open**

Digital Output: The active state is

**Helpful Hints...**

The network ipcam str provides a general I/O terminal block with one digital input and one relay switch for device control. Pin DI+ and pin DI- can be connected to an external sensor and the state of voltage will be monitored from the initial state 'LOW'. The relay switch of pin DO+ and pin DO- can be used to turn on or off the external device. Please refer to manual for detail connection diagram.

LED in the rear panel of your camera, there is a LED beside the network adapter. ON: The LED will flash a light to indicate if the network is working or not. OFF: No light will show, forth option is turn off.

# ICR

The Infrared Cut-Removable(ICR) filter can be disengaged for increased sensitivity in low light environments. The ICR filter will automatically engage depending on the ambient light, allowing the camera to be effective in day/night environments.

**Automatic (Default):** The day/Night mode is set automatically. It will typically use day mode, but will use night mode if installed in a dark area.

**Day Mode:** The Day mode disables the IR Cut Filter.

**Night Mode:** The Night mode enables the IR Cut Filter.

**Schedule Mode:** You can specify a time period for which Day mode will always be used.

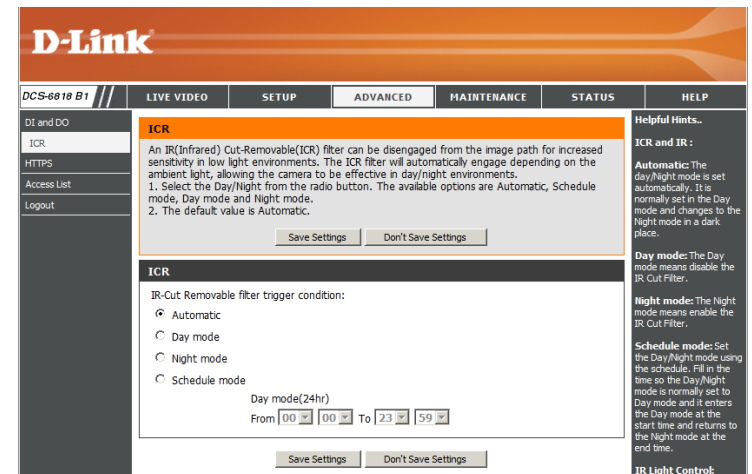

# HTTPS

This page allows you to install and activate an HTTPS certificate for secure access to your camera.

## Enable HTTPS

**Secure Connection:** Enable the HTTPS service.

**Create Certificate Method:** Choose the way the certificate should be created. Three options are available:

- Create a self-signed certificate automatically
- Create a self-signed certificate manually
- Create a certificate request and install

**Status:** Displays the status of the certificate.

**Note:** The certificate cannot be removed while the HTTPS is still enabled. To remove the certificate you must first uncheck **Enable HTTPS secure connection**.

The screenshot shows the D-Link web interface for configuring HTTPS. The main content area is titled "HTTPS" and contains the following text: "To enable HTTPS, you have to create and install certificate first." Below this text are two buttons: "Save Settings" and "Don't Save Settings".

The "HTTPS" section includes a checkbox for "Enable HTTPS secure connection" which is currently unchecked. Underneath, there is a "Create certificate method" section with three radio button options: "Create self-signed certificate automatically" (which is selected), "Create self-signed certificate manually", and "Create certificate request and install".

Below the radio buttons is a "Create certificate:" label followed by a "Create" button.

The "CERTIFICATE INFORMATION" section shows the "Status" as "No installed". There are three buttons: "CSR Property", "Certificate Property", and "Remove".

At the bottom of the main content area are two buttons: "Save Settings" and "Don't Save Settings".

On the right side, there is a "Helpful Hints..." section. It contains the following text: "Enable HTTPS secure connection: allows you to enable HTTPS service." Below this is "HTTP & HTTPS: This is default enable." and "HTTPS only: Select this will redirect all the HTTP connection to HTTPS pages automatically." A "Note:" follows, stating: "1. The certificate can't be removed while the HTTPS is still enable. To remove the certificate you have to uncheck the 'Enable HTTPS secure connection' first."

# Access List

Here you can set access permissions for users to view your DCS-6815/6817/6818.

**Allow list:** The list of IP addresses that have the access right to the camera.

**Start IP address:** The starting IP Address of the devices (such as a computer) that have permission to access the video of the camera. Click **Add** to save the changes made.

**Note:** A total of seven lists can be configured for both columns.

**End IP address:** The ending IP Address of the devices (such as a computer) that have permission to access the video of the camera.

**Delete allow list:** Remove the customized setting from the Allow List.

**Deny list:** The list of IP addresses that have no access right to the camera.

**Delete deny list:** Remove the customized setting from the Delete List.

**For example:**

When the range of the Allowed List is set from 1.1.1.0 to 192.255.255.255 and the range of the Denied List is set from 1.1.1.0 to 170.255.255.255. Only users with IPs located between 171.0.0.0 and 192.255.255.255 can access the Network Camera.

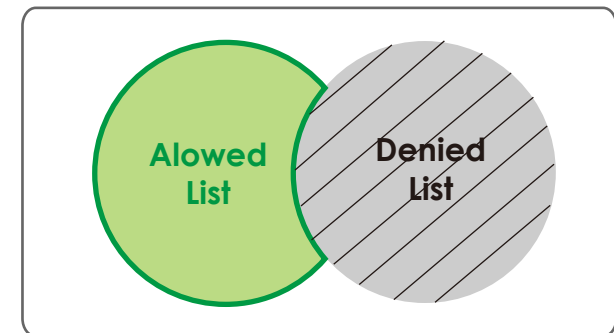
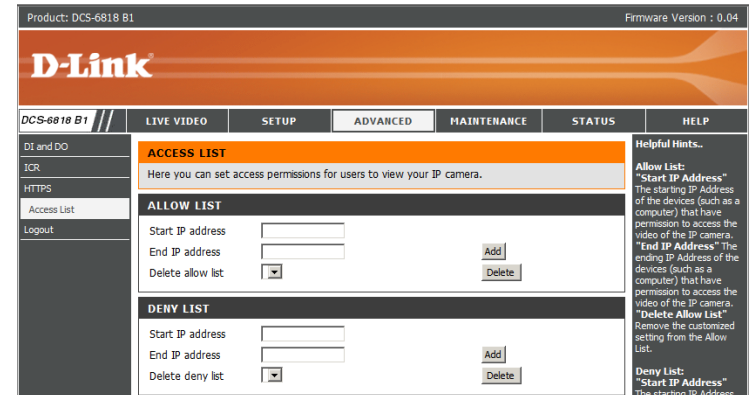

# Maintenance Admin

You may modify the name and administrator's password of your camera, as well as add and manage the user accounts for accessing the camera. You may also use this section to create the unique name and configure the OSD setting for your camera.

## Admin Password

**Setting:** Set a new password for the administrator's account.

**Add User Account:** Add new user account.

**User Name:** The user name for the new account.

**Password:** The password for the new account.

**User List:** All the existing user accounts will be displayed here. You may delete accounts included in the list, but please reserve at least one as guest.

**Camera Name:** Create a unique name for your camera that will be added to the file name prefix when creating a snapshot or a video clip.

**Enable OSD:** Select this option to enable the On-Screen Display feature for your camera.

**Label:** Enter a label for the camera.

**Show Time:** Select this option to enable the time-stamp display on the video screen.

**DCS-6818 B1** // LIVE VIDEO SETUP ADVANCED MAINTENANCE STATUS HELP

**ADMIN**

Here you can change the administrator's password for your IP camera as well as add and/or delete user account(s). You can configure the information, such as IP camera's name and time via this page. You can also enable the OSD (On-Screen Display) feature in order to display the IP camera name and time stamp for your video recordings.

**ADMIN PASSWORD SETTING**

New Password  8 characters maximum  
Retype Password  Save

**ADD USER ACCOUNT**

User Name  20 users maximum  
New Password  8 characters maximum  
Retype Password   
Add

**USER LIST**

User Name  -- User list -- Delete

**DEVICE SETTING**

IP camera Name  DCS-6818 B1 30 characters maximum  
 Enable OSD  
Label  DCS-6818 B1 30 characters maximum  
Show time   
Save

**Helpful Hints...**

Enabling OSD, the IP camera name and time will be displayed on the video screen for the user.

For security purposes, it is recommended that you change the password for your administrator account. Be sure to write down the new password to avoid having to reset the IP camera in the event that it is forgotten.



# Backup and Restore

In this section, you may backup, restore and reset the camera configuration, or reboot the camera.

**Save To Local Hard Drive:** You may save and document your current settings into your computer.

**Local From Local Hard Drive:** Locate a pre-saved configuration by clicking **Browse** and then restore the pre-defined settings to your camera by clicking **Load Configuration**.

**Restore to Factory Default:** You may reset your camera and restore the factory settings by clicking **Restore Factory Defaults**.

**Reboot Device:** This will restart your camera.

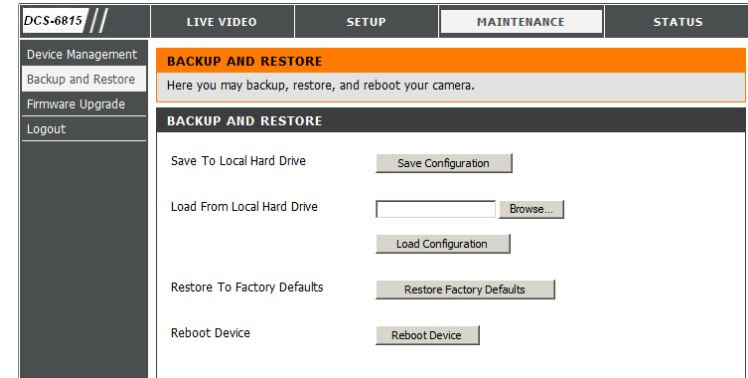

# Firmware Upgrade

The camera's current firmware version will be displayed on this screen. You may visit the D-Link Support Website to check for the latest available firmware version.

To upgrade the firmware on your DCS-6815/6817/6818, please download and save the latest firmware version from the D-Link Support Page to your local hard drive. Locate the file on your local hard drive by clicking the **Browse** button. Select the file and click the **Upload** button to start upgrading the firmware.

## Current Firmware

**Version:** Displays the detected firmware version.

**Current Product Name:** Displays the camera model name.

**File Path:** Locate the file (upgraded firmware) on your hard drive by clicking **Browse**.

**Upload:** Uploads the new firmware to your camera.

DCS-6815 //	LIVE VIDEO	SETUP	MAINTENANCE	STATUS
Device Management	<b>FIRMWARE UPGRADE</b> A new firmware upgrade may be available for your IP camera. It is recommended to keep your IP camera firmware up-to-date to maintain and improve the functionality and performance of your internet camera. Click here <a href="#">D-Link Support Page</a> to check for the latest firmware version available.  To upgrade the firmware on your IP camera, please download and save the latest firmware version from the D-Link Support Page to your local hard drive. Locate the file on your local hard drive by clicking the Browse button. Once you have found and opened the file using the browse button, click the "Upload" button to start the firmware upgrade.			
Backup and Restore				
Firmware Upgrade				
Logout				
<b>FIRMWARE INFORMATION</b> Current Firmware Version: DCS-6815 Current Product Name : 1.0.9				
<b>FIRMWARE UPGRADE</b> File Path: <input type="text"/> <input type="button" value="Browse..."/> <input type="button" value="Upload"/>				

# Status

## Device Info

This section displays detailed information about your device and network settings.

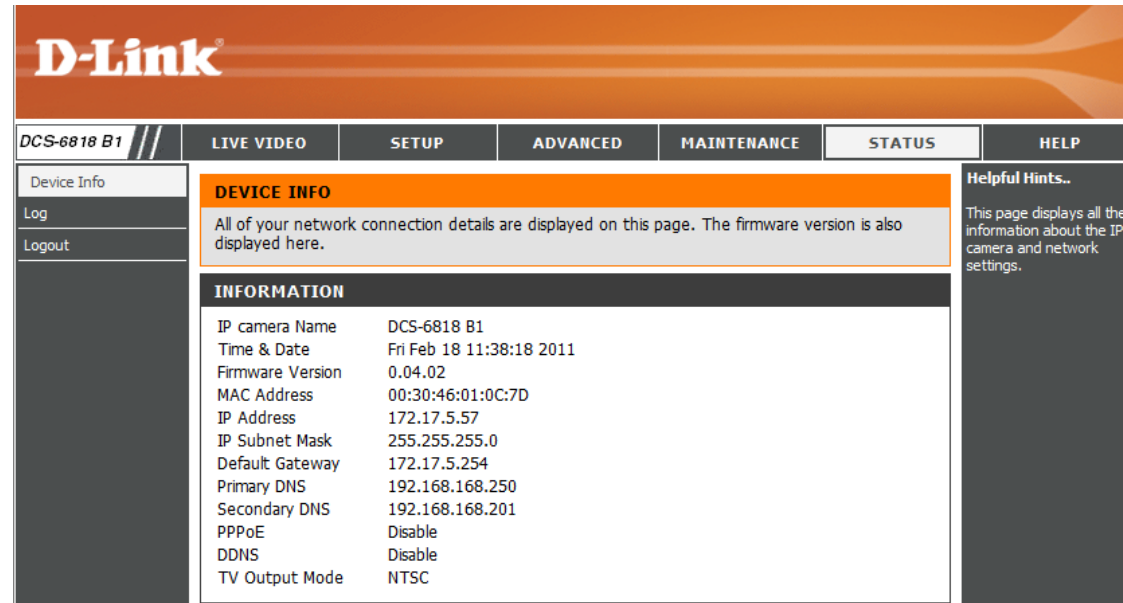

The screenshot shows the D-Link web interface for a DCS-6818 B1 device. The top navigation bar includes 'LIVE VIDEO', 'SETUP', 'ADVANCED', 'MAINTENANCE', 'STATUS', and 'HELP'. The 'STATUS' tab is selected, and the 'Device Info' sub-tab is active. The main content area is titled 'DEVICE INFO' and contains a summary paragraph and an 'INFORMATION' table. A 'Helpful Hints..' sidebar is visible on the right.

INFORMATION	
IP camera Name	DCS-6818 B1
Time & Date	Fri Feb 18 11:38:18 2011
Firmware Version	0.04.02
MAC Address	00:30:46:01:0C:7D
IP Address	172.17.5.57
IP Subnet Mask	255.255.255.0
Default Gateway	172.17.5.254
Primary DNS	192.168.168.250
Secondary DNS	192.168.168.201
PPPoE	Disable
DDNS	Disable
TV Output Mode	NTSC

# Logs

This page displays the log information of your camera. You may download the information by clicking **Download**. You may also click **Clear** to delete the saved log information.

Product: DCS-6818 B1		Firmware Version : 0.04					
							
DCS-6818 B1		LIVE VIDEO	SETUP	ADVANCED	MAINTENANCE	STATUS	HELP
Device Info	<b>SYSTEM LOG</b>					Helpful Hints..	
Log	The system log records IP camera events that have occurred.					You can save the log to your local hard IP camera by clicking the Download button, and you can clear the log by clicking on the Clear button.	
Logout	<b>CURRENT LOG</b>						
	<ol style="list-style-type: none"> <li>1. 2011-02-09 10:01:12 admin LOGIN OK FROM 172.17.5.95</li> <li>2. 2011-02-09 09:49:46 IP CAMERA ACQUIRE DHCP IP 172.17.5.103</li> <li>3. 2011-02-09 09:49:29 SYSTEM BOOTING</li> <li>4. 2011-01-21 16:02:18 admin SET EVENT RECORD 1</li> <li>5. 2011-01-21 16:01:02 admin LOGIN OK FROM 172.17.5.22</li> <li>6. 2011-01-21 16:00:12 admin SET EVENT TYPE 2</li> <li>7. 2011-01-21 15:59:51 admin SET EVENT TYPE 1</li> <li>8. 2011-01-21 15:59:21 admin SET EVENT SERVER 1</li> <li>9. 2011-01-21 15:56:19 admin SET EVENT RECORD 1</li> <li>10. 2011-01-21 15:55:56 admin SET EVENT MEDIA 1</li> <li>11. 2011-01-21 15:54:30 admin SET EVENT TYPE 1</li> <li>12. 2011-01-21 15:53:22 admin LOGIN OK FROM 172.17.5.84</li> <li>13. 2011-01-21 15:43:20 admin FROM 172.17.5.22 SET ALL IMAGE DATA DEFAULT</li> <li>14. 2011-01-21 15:43:13 admin FROM 172.17.5.22 SET ALL IMAGE DATA DEFAULT</li> <li>15. 2011-01-21 15:21:58 admin LOGIN OK FROM 172.17.5.22</li> <li>16. 2011-01-21 15:19:43 IP CAMERA ACQUIRE DHCP IP 172.17.5.145</li> <li>17. 2011-01-21 15:19:27 SYSTEM BOOTING</li> <li>18. 2011-01-21 15:15:50 NETWORK LOST</li> <li>19. 2011-01-20 00:46:16 admin LOGIN OK FROM 172.17.5.125</li> <li>20. 2011-01-20 00:45:58 IP CAMERA ACQUIRE DHCP IP 172.17.5.145</li> </ol>						
	<input type="button" value="First Page"/> <input type="button" value="Previous 20"/> <input type="button" value="Next 20"/>						
	<input type="button" value="Clear"/> <input type="button" value="Download"/>						

# Help

This page provides helpful information regarding camera operation.

The screenshot displays the D-Link camera web interface. At the top, it shows 'Product: DCS-6818 B1' and 'Firmware Version : 0.04'. The D-Link logo is prominently displayed. Below the logo is a navigation bar with tabs for 'DCS-6818 B1', 'LIVE VIDEO', 'SETUP', 'ADVANCED', 'MAINTENANCE', 'STATUS', and 'HELP'. The 'HELP' tab is selected, and the main content area is divided into sections: 'HELP' (with links to LIVE VIDEO, SETUP, MAINTENANCE, ADVANCED, and STATUS), 'LIVE VIDEO' (with a link to Camera), 'SETUP' (with links to Setup Wizard, Network Setup, Dynamic DNS, Image Setup, Audio and Video, Motion Detection, Time and Date, Event Setup, and Lens Control), 'ADVANCED' (with links to DI and DO, HTTPS, and Access List), and 'MAINTENANCE' (with links to Admin, System, and Firmware Upgrade). A sidebar on the left contains 'Help' and 'Logout' links.

Product: DCS-6818 B1	Firmware Version : 0.04					
<b>D-Link</b>						
DCS-6818 B1	LIVE VIDEO	SETUP	ADVANCED	MAINTENANCE	STATUS	HELP
Help	<b>HELP</b> <ul style="list-style-type: none"><li>• <a href="#">LIVE VIDEO</a></li><li>• <a href="#">SETUP</a></li><li>• <a href="#">MAINTENANCE</a></li><li>• <a href="#">ADVANCED</a></li><li>• <a href="#">STATUS</a></li></ul>					
Logout	<b>LIVE VIDEO</b> <ul style="list-style-type: none"><li>• <a href="#">Camera</a></li></ul>					
	<b>SETUP</b> <ul style="list-style-type: none"><li>• <a href="#">Setup Wizard</a></li><li>• <a href="#">Network Setup</a></li><li>• <a href="#">Dynamic DNS</a></li><li>• <a href="#">Image Setup</a></li><li>• <a href="#">Audio and Video</a></li><li>• <a href="#">Motion Detection</a></li><li>• <a href="#">Time and Date</a></li><li>• <a href="#">Event Setup</a></li><li>• <a href="#">Lens Control</a></li></ul>					
	<b>ADVANCED</b> <ul style="list-style-type: none"><li>• <a href="#">DI and DO</a></li><li>• <a href="#">HTTPS</a></li><li>• <a href="#">Access List</a></li></ul>					
	<b>MAINTENANCE</b> <ul style="list-style-type: none"><li>• <a href="#">Admin</a></li><li>• <a href="#">System</a></li><li>• <a href="#">Firmware Upgrade</a></li></ul>					

# DI/DO Configuration

## DI/DO Pin Block Specifications

Pin	Definition	Cable
1	AC 24-1/DC (+)	20AWG
2	ALM NC	
3	AC 24-2/DC (-)	20AWG
4	ALM NO	
5	FG	20AWG
6	ALM COM	
7		24AWG
8		
9		
10		
11	ISOG	
12	ALM-1	
13	ALM-3	
14	ALM-2	
15	ALM-4	
16	ALM-5	
17	ALM-6	
18	ALM-7	
19	ALM-8	
20	ALM GND	
21	VGND	24AWG
22	Video	

# Digital Input Diagram

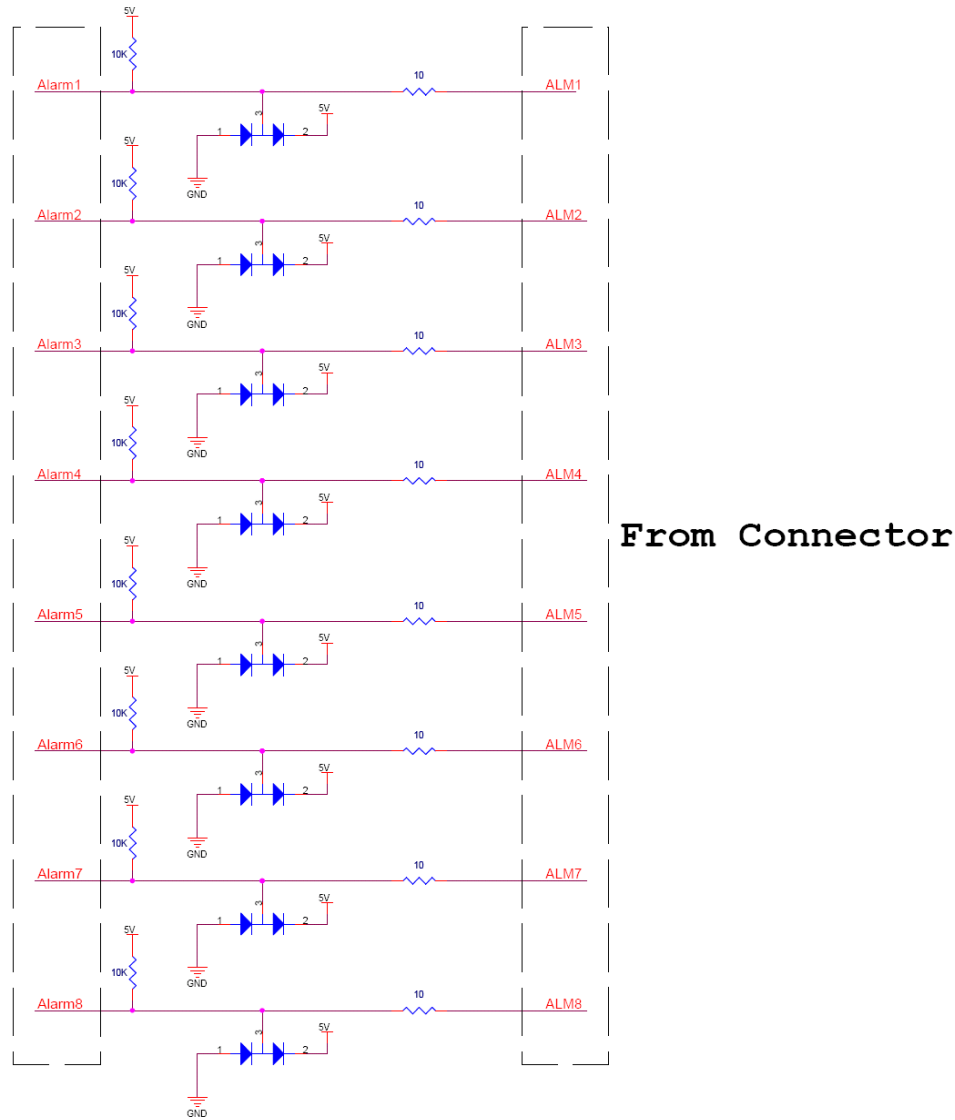

**Alarm Input: ALM-1 ~ 8 - ALM GND**

# Digital Output Diagram

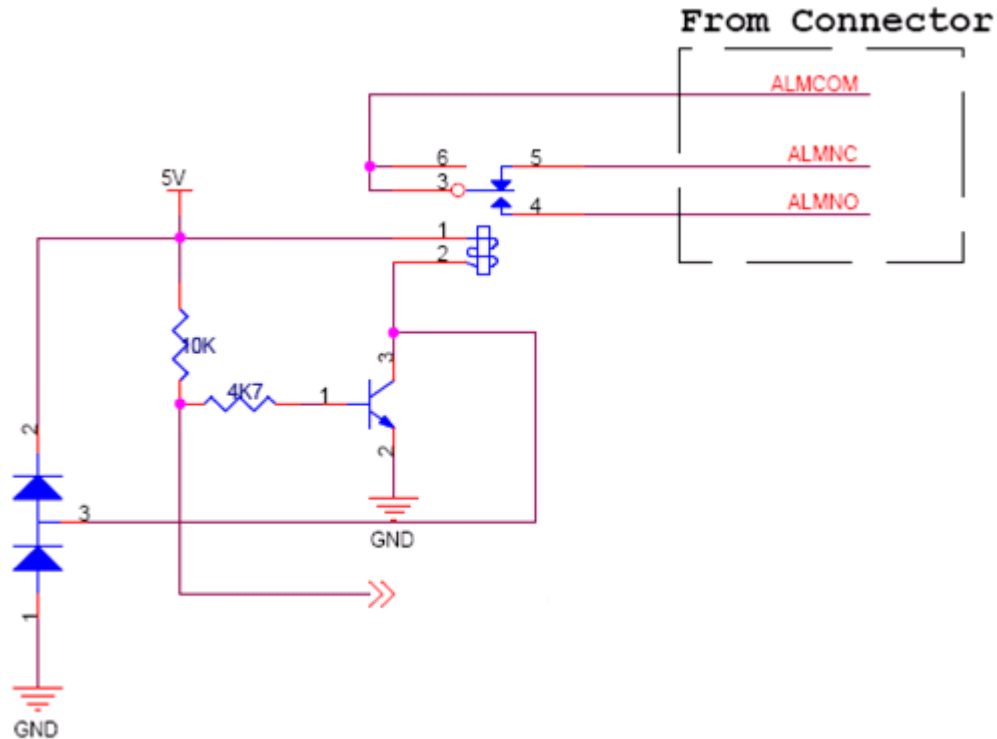

**Alarm Output:** ALM NC / ALM NO – ALM COM (NC: normal close, NO: normal open)  
 Max. load 3A, max. voltage 120V AC relay output.



# Troubleshooting

## **1. What is the maximum number of users that can be allowed to access DCS-6815/6817/6818 simultaneously?**

The maximum number of users that can log onto the Internet Camera at the same time is 10. Please keep in mind the overall performance of the transmission speed will slow down when many users are logged on.

## **2. Can the Internet Camera be used outdoors?**

The DCS-6815/6817/6818 is IP66 certified and is weatherproof. Please use appropriate weatherproof cabling for safe installation.

## **3. When physically connecting the Internet Camera to a network what network cabling is required?**

The Internet Camera uses Category 5 UTP cable allowing 10 Base-T and 100 Base-T networking.

## **4. Can the DCS-6815/6817/6818 be connected to the network if it consists of only private IP addresses?**

Yes, the Internet Camera can be connected to a LAN with private IP addresses.

## **5. Why does the Internet Camera work locally but not externally?**

This might be caused by network firewall protection. The firewall may need to have some settings changed in order for the Internet Camera to be accessible outside your local LAN. Check with the Network Administrator for your network.

Make sure that the Internet Camera isn't conflicting with any Web server you may have running on your network. The default router setting might be a possible reason. Check that the configuration of the router settings allow the Internet Camera to be accessed outside your local LAN.

## **6. Noisy images occur. How can I solve the problem?**

The video images might be noisy if the Internet Camera is used in a very low light environment. To solve this issue you need more lighting.

# Technical Specifications

Camera	Camera Hardware Profile	<ul style="list-style-type: none"> <li>▪ Sony Super HAD-II 1/4" CCD sensor</li> <li>▪ Minimum illumination 0.1 Lux (Color); 0.01 Lux (B/W)</li> <li>▪ 650 TVL</li> <li>▪ Built-in Infrared-Cut Removable (ICR) Filter module</li> <li>▪ S/N ratio &gt; 50dB (AGC off)</li> <li>▪ Electronic shutter 1/1 ~ 1/10K sec.</li> <li>▪ 1-12x variable digital zoom</li> <li>▪ Aperture : F1.6 ~ 4.5</li> </ul>	DCS-6815	Optical Zoom: 18X Focal length 3.4~61.2 mm Angle of View (Horizontal) : 3.6° ~ 60.8°
		<ul style="list-style-type: none"> <li>▪ Cruise: 8</li> <li>▪ Pan and tilt speed proportional to zoom ratio</li> <li>▪ Resume after Power loss</li> <li>▪ Home Function: Preset, Sequence, Auto pan, Cruise</li> <li>▪ Auto Flip: Mechanical/Digital/Off</li> <li>▪ Digital Slow Shutter</li> <li>▪ Image Freeze</li> <li>▪ Image Inverse</li> </ul>	DCS-6817	Optical Zoom: 30X Focal length: 3.4~102 mm Angle of View (Horizontal): 2.2° ~ 60.8°
		<ul style="list-style-type: none"> <li>▪ 16 configurable privacy masks</li> <li>▪ Configurable white balance, shutter speed, brightness, saturation, contrast, sharpness</li> </ul>	DCS-6818	Optical Zoom: 36X Focal Length: 3.4~122.4 mm Angle of View (Horizontal): 1.8° ~ 60.8
	PTZ Hardware Profile	<ul style="list-style-type: none"> <li>▪ Pan travel: 360° endless</li> <li>▪ Tilt Travel: -10° ~ 190°</li> <li>▪ Manual Speed: 0.5°~90°/s</li> <li>▪ Presets : 256 points</li> <li>▪ Preset Accuracy: 0.225°</li> <li>▪ Preset Speed: 5°~400°/s</li> <li>▪ Sequence path: 8</li> <li>▪ Auto Pan: 4</li> </ul>		
	Image Features	<ul style="list-style-type: none"> <li>▪ Configurable image size, quality, frame rate, and bit rate</li> <li>▪ Time stamp and text overlays</li> <li>▪ Configurable motion detection windows</li> </ul>		
	Video Compression	<ul style="list-style-type: none"> <li>▪ H.264/MPEG4/MJPEG format compression simultaneously</li> <li>▪ JPEG for still image</li> </ul>		<ul style="list-style-type: none"> <li>▪ H.264/MPEG-4 multicast streaming</li> </ul>
	Video Resolution	<b>NTSC Support:</b> <ul style="list-style-type: none"> <li>▪ Up to 30 fps at 176 x 120</li> <li>▪ Up to 30 fps at 352 x 240</li> <li>▪ Up to 30 fps at 720 x 480</li> </ul>	<b>PAL Support:</b> <ul style="list-style-type: none"> <li>▪ Up to 25 fps at 176 x 144</li> <li>▪ Up to 25 fps at 352 x 288</li> <li>▪ Up to 25 fps at 720 x 576</li> </ul>	
	Audio Support	2-way Audio Support with G.726 Compression		
External Device Interface	<ul style="list-style-type: none"> <li>▪ 8 Alarm inputs</li> <li>▪ 1 Alarm outputs</li> </ul>	<ul style="list-style-type: none"> <li>▪ Audio input / output</li> <li>▪ Video output</li> </ul>		
Network	Network Protocols	IPv4, TCP/IP, UDP, ICMP, DHCP Client, NTP Client (D-Link), DNS Client, DDNS Client (D-Link), SMTP Client, FTP Client, HTTP / HTTPS, Samba Client, PPPoE, UPnP Port Forwarding, RTP / RTSP/ RTCP, IP filtering, 3GPP, IGMP, ONVIF Compliant		
	Security	<ul style="list-style-type: none"> <li>▪ Administrator and user group protection</li> <li>▪ Password authentication</li> </ul>		<ul style="list-style-type: none"> <li>▪ HTTP and RTSP digest encryption</li> </ul>

System Management	<b>System Requirements for Web Interface</b>	<ul style="list-style-type: none"> <li>▪ Operating system: Microsoft windows, 2000, XP, Vista, 7</li> <li>▪ Browser: Internet explorer, Firefox, Netscape, Mozilla, Opera</li> </ul>
	<b>Event Management</b>	<ul style="list-style-type: none"> <li>▪ Motion detection</li> <li>▪ Event notification and upload snapshots/video clips via HTTP, SMTP or FTP</li> <li>▪ Supports multiple HTTP, SMTP and FTP servers</li> <li>▪ Multiple event notification</li> <li>▪ Multiple recording methods for easy backup</li> </ul>
	<b>Remote Management</b>	<ul style="list-style-type: none"> <li>▪ Configuration accessible via web browser</li> <li>▪ Take snapshots/video clips and save to local hard drive or NAS via web browser</li> </ul>
	<b>Mobile Support</b>	Windows 2000 / XP / Vista / Win 7 / Pocket PC / Mobile Phone which 3GPP
	<b>D-ViewCam™ System Requirements</b>	<ul style="list-style-type: none"> <li>▪ Operating System: Microsoft Windows R 7 / Vista / XP</li> <li>▪ Web Browser: Internet Explorer 6 or higher</li> <li>▪ Protocol: Standard TCP/IP</li> </ul>
	<b>D-ViewCam™ Software Functions</b>	<ul style="list-style-type: none"> <li>▪ Remote management/control of up to 32 cameras</li> <li>▪ Viewing of up to 32 cameras on one screen</li> <li>▪ Supports all management functions provided in web interface</li> <li>▪ Scheduled motion triggered, or manual recording options</li> </ul>
General	<b>Power Input</b>	AC 24 V / 3A
	<b>Max. Power Consumption</b>	Max 65 W (with heater)
	<b>Operating Temperature</b>	-40° to 50° C (-40° to 122° F)
	<b>Storage Temperature</b>	-20° to 70° C (-4° to 158° F)
	<b>Weatherproof</b>	IP-66 standard
	<b>Vandal-proof</b>	IK-10 standard
	<b>Humidity</b>	20% to 80% non-condensing
	<b>Weight</b>	2.6 kg (5.9 lbs)
	<b>Certifications</b>	CE (Class A), CE LVD (EN60965-1), FCC (Class A), ICES-003, C-Tick

Dimensions

