

Measurement Report

Issued Date : Jun. 26, 2003
Project No. : 03E0302
Equipment : 16 Port 10/100/1000Mbps Gigabit Ethernet Switch
Model No. : DGS-1016T; BDGS-1016T
Applicant : D-Link Corp.
No. 20 Park Ave.II, Science-Based Industrial Park,
Hsin-Chu, Taiwan, R.O.C.

Tested by :
Neutron Engineering Inc. EMC Laboratory
Data of Test :
Jun. 24, 2003 ~ Jun. 25, 2003

Testing Engineer :

Technical Manager :

Authorized Signatory :

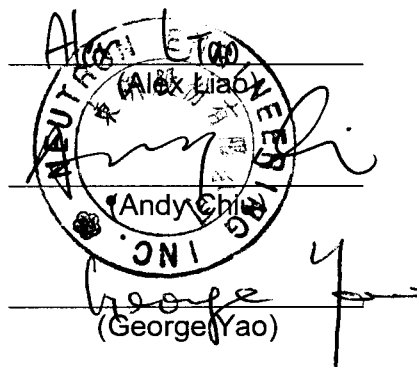

(George Yao)

NEUTRON ENGINEERING INC.

No. 132-1, Lane 329, Sec. 2, Palain Rd.,
Shijr Jen, Taipei, Taiwan
TEL : (02) 2646-5426 FAX : (02) 2646-6815



Declaration

Neutron represents to the client that testing is done in accordance with standard procedures as applicable and that test instruments used has been calibrated with the standards traceable to National Measurement Laboratory (**NML**) of **R.O.C.**, or National Institute of Standards and Technology (**NIST**) of **U.S.A.**

Neutron's reports apply only to the specific samples tested under conditions. It is manufacture' s responsibility to ensure that additional production units of this model are manufactured with the identical electrical and mechanical components. **Neutron** shall have no liability for any declarations , inferences or generalizations drawn by the client or others from **Neutron** issued reports.

Neutron' s reports must not be used by the client to claim product endorsement by the authorities or any agency of the Government.

This report is the confidential property of the client. As a mutual protection to the clients, the public and **Neutron-self**, extracts from the test report shall not be reproduced except in full with **Neutron'** s authorized written approval.

Neutron' s laboratory quality assurance procedures are in compliance with the **ISO Guide 17025** requirements, and accredited by the conformity assessment authorities listed in this test report.

Limitation

For the use of the authority's logo is limited unless the Test Standard(s)/Scope(s)/Item(s) mentioned in this test report is (are) included in the conformity assessment authorities acceptance respective.

Assessment Authorities



Test Standard/Scope/Item Acceptance

FCC Part 15 Subpart B
IEC/CISPR22
AS/NZS 3548
CNS 13438

FCC Part 15 Subpart B
CISPR 22/EN 55022
AS/NZS 3548
VCCI -Technical Requirement
CNS 13438
SS IEC/CISPR 22
IEC/EN 61000-3-2 IEC/EN 61000-4-5
IEC/EN 61000-3-3 IEC/EN 61000-4-6
IEC/EN 61000-4-2 IEC/EN 61000-4-8
IEC/EN 61000-4-3 IEC/EN 61000-4-11
IEC/EN 61000-4-4

CISPR 22/EN 55022
IEC/EN 61000-3-2 IEC/EN 61000-4-5
IEC/EN 61000-3-3 IEC/EN 61000-4-6
IEC/EN 61000-4-2 IEC/EN 61000-4-8
IEC/EN 61000-4-3 IEC/EN 61000-4-11
IEC/EN 61000-4-4

VCCI -Technical Requirement

Table of Contents

	Page
1 General Information	6
1.1 Applicant	6
1.2 Manufacturer	6
1.3 Equipment Under Tested	6
1.4 OEM Brand/Model	6
1.5 Product Description	6
1.6 Connecting I/O Port(s)	6
1.7 Power Supplied	6
1.8 Products Covered	7
1.9 Model Difference (Series, Versions, if any)	7
1.10 EUT Modifications	7
1.11 Electric Block Diagram	7
1.12 Photos of EUT	7
2 RFI Emissions Measurement	8
2.1 Test Facility	8
2.2 Standard Compliance	8
2.3 Test Methodology	8
2.4 Deviations from Standard Test Method	8
2.5 Sample(s) Tested	8
2.6 Measurement Instrument	8
2.7 Measurement Uncertainty	8
2.8 Tested System Set-Up/Configuration Details	8
Table -1 Equipments Used in Tested System	9
Diagram -1 Block diagram showing the configuration of system tested	10
Table - 2 Equipments Used in Tested System	11
Table - 3 Information of Interface Cable	11
2.9 Max.(Worst Case) RF Emission Evaluation	12
2.10 EUT Operation	12
3 Justification	13
3.1 Limitations	13
3.1.1 Power Line Conducted Emission	13
3.1.2 Radiated Emission Limits	13
3.2 Measurement Justification	13
3.2.1 Conducted Emission	13
3.2.2 Radiated Emission	13
3.3 Measurement Data	13

Table of Contents		Page
3.3 Measurement Data		14
Table 4 Conducted Emission Data		15
Table 5 Radiated Emission Data		19
4 Attachment		23
A. EUT Modification Description		24
B. EUT Test Photos		25
C. EUT Photos		28

1. General Information

1.1 Applicant

Name D-Link Corp.

Address No. 20 Park Ave.II, Science-Based Industrial Park, Hsin-Chu, Taiwan, R.O.C.

1.2 Manufacturer

Name N/A

Address N/A

1.3 Equipment Under Tested

Name: 16 Port 10/100/1000Mbps Gigabit Ethernet Switch

Trade Name: D-Link

Model No.: DGS-1016T; BDGS-1016T

1.4 OEM Brand/Model (if applicable)

OEM Brand(s)/Model(s) except the basic model in sub-clause 1.3 is(are) the follows:

OEM Brand: N/A

Model No.: N/A

1.5 Product Descriptions(Application/Features/Specification)

The EUT is a 16 Port 10/100/1000Mbps Gigabit Ethernet Switch.

Based on the application, features, or specification exhibited in User's Manual, the EUT is considered as an ITE/Computing Device. More details of EUT technical specification, please refer to the User's Manual

1.6 Connecting I/O Port(s)

16 Ports RJ 45 8P8C

1.7 Power Supplied

Power Source: AC Mains.

Power Cord: Detachable, non-shielded type.

Power Rating: AC I/P 100-240Vac, 50-60Hz/DC O/P 5Vdc, 8A

1.8 Products Covered (if applicable)

The sample tested including the following sub-system/module/accessory :

Sub-system/ Module/ Accessory	Model/Type No.	Int. Inst./ Ext. Cont.
Power Supply	SA40-050100 (LEI)	Int. Inst
Power Supply	UP0401S-05L1 (UMEC)	Int. Inst

1.9 Model Difference (Series, Versions, if any)

Except the basic model no. (model designation of the sample tested in this test report), additional model no. covered is(are) :

N/A

1.10 EUT Modifications (if applicable)

No any modification required for the EUT to comply with the standards.

Please refer to the Attachment – **A**.

1.11 Photos of EUT

Please refer to the Attachment – **C**.

2. RFI Emissions Measurement

2.1 Test Facility

The test facilities used to collect the test data in this report is OS02 at the location of No.132-1, Lane 329, Sec. 2, Palain Road, Shijr City, Taipei, Taiwan.

2.2 Standard Compliance

The test data contained in this report relate only to the item(s) listed below :

Limitation Class A

CISPR 22 :1997+A1:2000/ VCCI -Technical Requirement (V-3/02.04)

2.3 Test Methodology

Both conducted and radiated testing were performed during the max. EMI emission evaluation.

Antenna to EUT distance is 10 m.

Test procedures according to the technical standards:

CISPR 22 :1997 +A1:2000/ VCCI -Technical Requirement (V-3/2000.04)

2.4 Deviations from Standard Test Method

N/A

2.5 Sample(s) Tested

The representative sample tested in this reports is(are): DGS-1016T

Test results in this test report relate only to the sample(s) tested.

The EUT has been tested according to the following environmental condition:

Input Power	110 Vac/60Hz
Temperature	26
Relative Humidity	70 %

2.6 Measurement Instruments

Valid measurement instruments used in this report refer to **Table-1** enclosed.

2.7 Measurement Uncertainty

The reported uncertainty of measurement $y \pm U$, where expanded uncertainty U is based on a standard uncertainty multiplied by a coverage factor of $k=2$, providing a level of confidence of approximately **95 %**.

A. Conducted Measurement :5.05dB

B. Radiated Measurement :

Test Site	Method	Measurement Frequency Range	Ant. H / V	U , (dB)	NOTE
OS-01	ANSI	30MHz ~ 200MHz	H	4.59	
		30MHz ~ 200MHz	V	4.80	
		200MHz ~ 1,000MHz	H	4.47	
		200MHz ~ 1,000MHz	V	5.03	
OS-01	VCCI	30MHz ~ 200MHz	H	4.59	Only for VCCI Report
		30MHz ~ 200MHz	V	4.48	Only for VCCI Report
		200MHz ~ 1,000MHz	H	4.47	Only for VCCI Report
		200MHz ~ 1,000MHz	V	4.73	Only for VCCI Report
OS-02	ANSI	30MHz ~ 200MHz	H	4.34	
		30MHz ~ 200MHz	V	5.15	
		200MHz ~ 1,000MHz	H	5.28	
		200MHz ~ 1,000MHz	V	4.53	
OS-02	VCCI	30MHz ~ 200MHz	H	4.34	Only for VCCI Report
		30MHz ~ 200MHz	V	4.77	Only for VCCI Report
		200MHz ~ 1,000MHz	H	4.91	Only for VCCI Report
		200MHz ~ 1,000MHz	V	4.53	Only for VCCI Report

2.8 Tested System Set-Up/Configuration Details

The system was configured for testing in a typical fashion (as a user would normally use) or in-accordance with the operating configuration specified in the user's manual. A Block Diagram (please refer to the Diagram - 1) and Photos (please refer to the attachment - B) showing the set-up/configuration of system tested. In addition, **Table-2** and **Table-3** provide a detail of all equipment items and cables information used in the system tested.

Table -1 Measurement Instruments List

Item	Instruments	Mfr/Brand	Model/Type No.	Serial No.	Calibrated Date	Next Cali. Date	Note
1	LISN	EMCO	3825/2	9605-2539	2003-06-09	2004-06-08	
2	LISN	Rolf Heine	NNB-2/16Z	98083	2002-11-01	2003-10-31	✓
3	LISN	Rolf Heine	NNB-2/16Z	98053	2002-11-15	2003-11-14	✓
4	Pulse Limiter	Electro-Metrics	EM-7600	112644	2002-12-09	2003-12-08	✓
5	50 Terminator	N/A	N/A	N/A	2003-05-09	2004-05-08	✓
6	Test Cable	N/A	C01	N/A	2002-12-10	2003-12-09	✓
7	Log-Bicon Antenna	MESS-ELEKTRONIK	VULB 9160	3058	2002-10-23	2003-10-22	
8	Log-Bicon Antenna	MESS-ELEKTRONIK	VULB 9160	3060	2002-10-23	2003-10-22	✓
9	Log-Bicon Antenna	MESS-ELEKTRONIK	VULB 9161	4022	2002-07-25	2003-07-24	
10	Test Cable	N/A	10M_OS01	N/A	2002-12-10	2003-12-09	
11	Test Cable	N/A	OS01-1/-2	N/A	2002-12-10	2003-12-09	
12	Test Cable	N/A	10M_OS02	N/A	2002-12-10	2003-12-09	✓
13	Test Cable	N/A	OS02-1/-2/-3	N/A	2002-12-10	2003-12-09	✓
14	RF Switch	Anritsu	MP59B	M65982	2001-12-09	2003-12-08	
15	Quasi-Peak Adapter	HP	85650A	2521A00844	2003-04-21	2003-10-20	✓
16	RF Pre-Selector	HP	85685A	2648A00417	2003-04-21	2003-10-20	✓
17	Spectrum Analyzer	HP	85680B	2634A03025	2003-04-21	2003-10-20	✓
18	Spectrum Monitor	HP	85662B	2648A13616	2003-04-21	2003-10-20	✓
19	Pre-Amplifier	Anritsu	MH648A	M09961	2002-12-09	2003-12-08	
20	Spectrum Analyzer	ADVAN TEST	R3261C	81720298	2002-08-14	2003-08-13	
21	Test Receiver	R&S	ESH3	860156/018	2002-10-22	2003-10-21	
22	Test Receiver	R&S	ESVP	860687/009	2002-12-06	2003-12-05	
23	Test Receiver	MEB	SMV41	130	2002-12-06	2003-12-05	✓
24	Test Receiver	PMM	PMM 9000	4310J01002	2002-10-06	2003-10-03	
25	Horn Antenna	EMCO	3115	9605-4803	2003-05-23	2004-05-22	
26	Test Receiver	R&S	ESMI	843977/005	2003-01-13	2004-01-12	
27	Pre-Amplifier	R&S	ESMI-Z7	1045.5020.9801 (612.278 041 00)	2003-05-19	2004-05-18	✓
28	Absorbing Clamp	R&S	MDS-21	841077/011	2002-08-23	2003-08-22	
29	Voltage Probe	R&S	ESH2-Z3	841.800/023	2002-08-28	2003-08-27	
30	Signal Generator	HP	8648A	3426A01034	2002-10-11	2004-10-08	
31	Antenna Mast	Chance Most	CMTB-1.5	N/A	N/A	N/A	✓
32	Turn Table	Chance Most	CMTB-1.5	N/A	N/A	N/A	✓

Remark :

(1)" ✓" indicates the instrument used in Test Report.

(2)" N/A" denotes No Model No. / Serial No. and No Calibration specified.

Diagram - 1
Block diagram showing the configuration of system tested

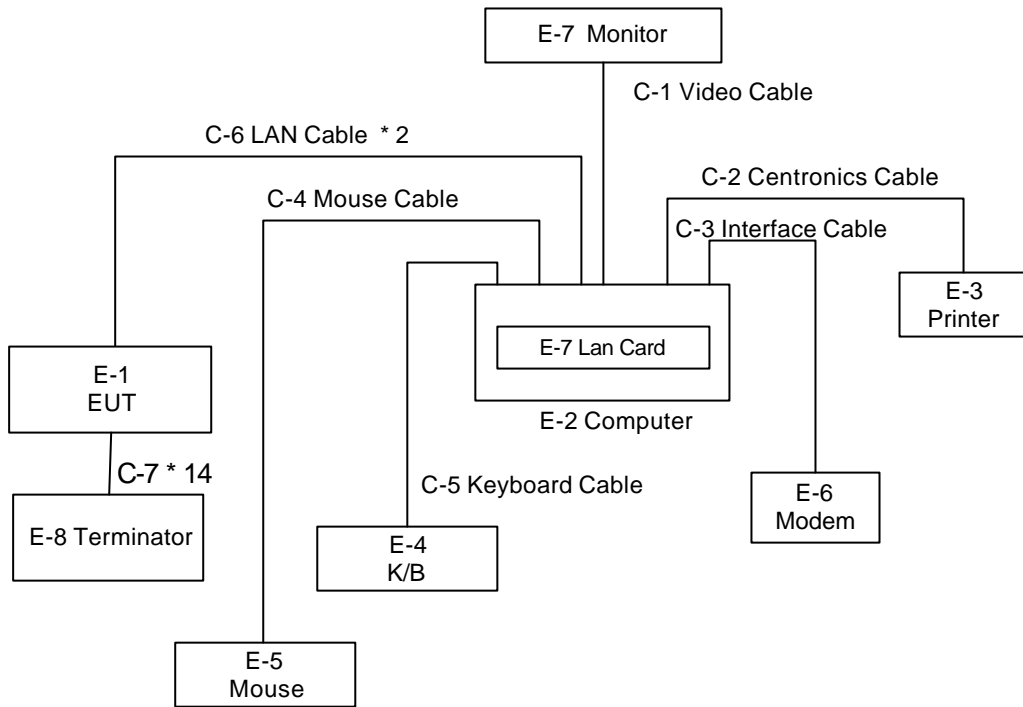

Table - 2 Equipments Used in Tested System

Item	Equipment	Mfr/Brand	Model/Type No.	FCC ID	Series No.	Note
E-1	16 Port 10/100/1000 Mbps Gigabit Ethernet Switch	D-Link	DGS-1016T	N/A(3)	N/A	EUT
E-2	PC	HP	Pavilion 8801	N/A(3)	SG12460765	
E-3	Printer	SII	DPU-414	N/A(3)	1045105A	
E-4	PS/2 K/B	HP	5181	N/A(3)	N/A	
E-5	PS/2 Mouse	HP	P8131	N/A(3)	5185-1212	
E-6	Modem	ACEEX	DM-1414V	N/A(3)	8041708	
E-7	Lan Card	D-LINK	DFE-500TX	KA2APC500X2	10M/100M	
E-7	Terminator	D-Link	N/A	N/A	N/A	

Note:

- (1) Unless otherwise denoted as EUT in 'Remark' column, device(s) used in tested system is a support equipment.
- (2) Unless otherwise marked as in 'Remark' column, Neutron consigns the support equipment to the tested system.
- (3) The support equipment was authorized by Declaration of Confirmation.

Table - 3 Information of Interface Cable

Item	Shielded Type	Ferrite Core	Length	Note
C-1	YES	YES	1.8M	
C-2	YES	NO	1.8M	
C-3	YES	NO	1.5M	
C-4	YES	NO	1.5M	
C-5	YES	NO	1.5M	
C-6	NO	NO	2M	
C-7	NO	NO	1.2M	

Note:

- (1) Unless otherwise marked as in 'Remark' column, Neutron consigns the support equipment to the tested system.
- (2) For detachable type I/O cable should be specified the length in cm in 'Length' column.

2.9 Max.(Worst Case) RF Emission Evaluation

- (a) Both conducted and radiated testing were performed during the max. EMI emission evaluation.
- (b) The system was configured for testing in a typical fashion (as a customer would normally use it). The EUT was connected to support equipment-personal computer. Peripherals of PC, such as monitor, keyboard, modem and printer were contained in this system in order to comply with the CISPR22 (1997) Rules requirement. The PC operated in the default 640 x 480 / 31.5 KHz VGA Graphic mode. This operating condition was tested and used to collect the included data.
- (c) To investigate the maximum EMI emission characteristics generates from EUT, the test system was pre-scanning tested base on the consideration of following EUT operation mode or test configuration mode which possible have effect on EMI emission level. Each of these EUT operation mode(s) or test configuration mode(s) mentioned above was evaluated respectively.

Mode 1 10 Mbps (Power Supply: SA40-050100)

Mode 2 100 Mbps (power supply: SA40-05100)

Mode 3 1000 Mbps (power supply: SA40-05100)

Mode 4 10 Mbps (power supply: UP0401S-05L1)

Mode 5 100 Mbps (power supply: UP0401S-05L1)

Mode 6 1000 Mbps (power supply: UP0401S-05L1)

The EUT system operated Mode 2, 3, 5, and 6, mentioned above was found to be the worst case during the pre-scanning test.

These operation modes were used for final testing and collecting test data included in this report.

2.10 EUT Operation

The EUT exercise program used during radiated and/or conducted emission measurement was designed to exercise the various system components in a manner similar to a typical use. The program contained on a PC hard disk and is auto-starting on power-up. Once loaded, the program sequentially exercises each system component in turn. The sequence used is:

1. Read (write) from (to) mass storage device (Disk).
2. Send "H" pattern to video port device (Monitor).
3. Send " H " pattern to parallel port device (Printer).
4. Send " H " pattern to serial port device (Modem).
5. EUT send/receive data to/from PC server (EUT - PC).
6. Repeated from 2 to 5 continuously.

As the keyboard and mouse are strictly input devices, no data is transmitted to (from) them during test. They are, however, continuously scanned for data input activity.

3. Justification

3.1 Limitations

3.1.1 Power Line Conducted Emission (Frequency Range 150KHz-30MHz)

Measurement Frequency Range (MHz)	Mains Terminal Class A Limits (dBuV)		Mains Terminals Class B Limits (dBuV)		Note CISPR FCC Std.
	QP Mode	AV Mode	QP Mode	AV Mode	
	0.15 - 0.50	79.00	66.00	66 - 56 *	
0.50 - 5.00	73.00	60.00	56.00	46.00	CISPR
5.00 - 30.0	73.00	60.00	60.00	50.00	CISPR
0.45-1.705	60.00	N/A	48.00	N/A	FCC
1.705-30.0	69.50	N/A	48.00	N/A	FCC

Notes:

- (1). The tighter limit applies at the band edges.
- (2). The limit of " * " marked band means the limitation decreases linearly with the logarithm of the frequency in the range.

3.1.2 Radiated Emission Limits (Frequency Range 30MHz-1000MHz)

Measurement Frequency Range (MHz)	Quasi-Peak Mode Class A Limits (dBuV/m)		Quasi-Peak Mode Class B Limits (dBuV/m)		Note CISPR FCC Std.
	10m	30m	10m	3m	
	30.00 -230.00	40.00	30.00	30.00	
230.0 -1000.0	47.00	37.00	37.00	47.00	CISPR
30.00 - 88.00	39.00	N/A	30.00	40.00	FCC
88.00 - 216.0	43.50	N/A	33.50	43.50	FCC
216.0 -960.0	46.00	N/A	36.00	46.00	FCC
above 960.0	49.50	N/A	46.00	54.00	FCC

Notes:

- (1). The tighter limit applies at the band edges.
- (2). Emission level (dBuV/m)=20log Emission level (uV/m).
- (3). A measuring distance of 10m is a primary used. However, either 3m or 10m (instead of 10m) distance may be allowed. If the distance is 3m, add 10dB to the QP-limit above. If the distance is 10m, subtract 10dB from the QP-limit above.

3.2 Measurement Justification

3.2.1 Conducted Emission

The initial step in collecting conducted emission data is a spectrum analyzer peak detector mode pre-scanning the measurement frequency range. Significant peaks are then marked and these signals are then Quasi Peak detector mode and Average detector mode re-measured.

Data of **Table - 4**. lists the significant emission frequencies, measured levels, limits and safe margins. All readings are Peak Mode measured unless otherwise stated as QP or AV in column of " Remark ".

If the Peak Mode measured value lower than both QP Mode and AV Mode Limit, EUT shall be deemed to compliance with both QP & AV Limits and then no additional QP Mode or AV Mode measurement performed.

If additional QP or AV Mode measurement needed, and if the QP Mode measured value compliance with the QP Mode Limit and lower than AV Mode Limit, the EUT shall be deemed to meet both QP & AV Limits and then only QP Mode was measured, but AV Mode was not performed.

3.2.2 Radiated Emission

The initial step in collecting conducted emission data is a spectrum analyzer peak detector mode pre-scanning the measurement frequency range. Significant peaks are then marked and then Quasi Peak detector mode re-measured.

Data of **Table - 5**. lists the significant emission frequencies, measured levels, limits and safe margins. All readings are Peak Mode measured unless otherwise stated as QP in column of " Remark ".

If the Peak Mode measured value compliance with and lower than Quasi Peak Mode Limit, the EUT shall be deemed to meet QP Limits and then no additional QP Mode measurement performed.

3.3 Measurement Data

Table - 4. Conducted Emission Data

Table - 5. Radiated Emission Data

Table 4 Conducted Emission Data

Special Notes : (EUT Operation Mode or Test Configuration Mode, if applicable)

Mode 2

Judgement : Passed by -25.89 dB at 0.24 MHz AVG X QP Line X Neutral

Freq. (MHz)	Terminal L/N	Measured(dBuV)		Limits(dBuV)		Safe Margins (dBuV)	
		QP-Mode	AV-Mode	QP-Mode	AV-Mode	Note	Note
0.19	Line	52.50	*	79.00	66.00	-26.50	(QP)
0.24	Line	53.01	*	79.00	66.00	-25.99	(QP)
0.31	Line	48.41	*	79.00	66.00	-30.59	(QP)
0.64	Line	44.11	*	73.00	60.00	-28.89	(QP)
13.48	Line	40.87	*	73.00	60.00	-32.13	(QP)
23.26	Line	41.47	*	73.00	60.00	-31.53	(QP)
0.18	Neutral	52.89	*	79.00	66.00	-26.11	(QP)
0.24	Neutral	53.11	*	79.00	66.00	-25.89	(QP)
0.31	Neutral	47.61	*	79.00	66.00	-31.39	(QP)
0.64	Neutral	45.21	*	73.00	60.00	-27.79	(QP)
16.31	Neutral	42.45	*	73.00	60.00	-30.55	(QP)
24.40	Neutral	37.86	*	73.00	60.00	-35.14	(QP)

Remark :

- (1) Reading in which marked as QP means measurements by using are Quasi-Peak Mode with Detector BW=9KHz ; SPA setting in RBW=10KHz,VBW =10KHz, Swp. Time = 0.3 sec./MHz。 Reading in which marked as AV means measurements by using are Average Mode with instrument setting in RBW=1MHz,VBW=10Hz, Swp. Time =0.3 sec./MHz。
- (2) All readings are QP Mode value unless otherwise stated AVG in column of 『Note』. If the QP Mode Measured value compliance with the QP Limits and lower than AVG Limits, the EUT shall be deemed to meet both QP & AVG Limits and then only QP Mode was measured, but AVG Mode didn't perform。 In this case, a " * " marked in AVG Mode column of Interference Voltage Measured。
- (3) Measuring frequency range from 150KHz to 30MHz。

Table 4 Conducted Emission Data

Special Notes : (EUT Operation Mode or Test Configuration Mode, if applicable)

Mode 3

Judgement : Passed by -25.39 dB at 0.24 MHz AVG X QP Line X Neutral

Freq. (MHz)	Terminal L/N	Measured(dBuV)		Limits(dBuV)		Safe Margins	
		QP-Mode	AV-Mode	QP-Mode	AV-Mode	(dBuV)	Note
0.18	Line	53.09	*	79.00	66.00	-25.91	(QP)
0.24	Line	52.01	*	79.00	66.00	-26.99	(QP)
0.31	Line	47.31	*	79.00	66.00	-31.69	(QP)
0.49	Line	43.41	*	79.00	66.00	-35.59	(QP)
0.64	Line	45.01	*	73.00	60.00	-27.99	(QP)
24.40	Line	46.36	*	73.00	60.00	-26.64	(QP)
0.18	Neutral	52.79	*	79.00	66.00	-26.21	(QP)
0.19	Neutral	53.00	*	79.00	66.00	-26.00	(QP)
0.24	Neutral	53.61	*	79.00	66.00	-25.39	(QP)
0.64	Neutral	45.61	*	73.00	60.00	-27.39	(QP)
2.51	Neutral	37.69	*	73.00	60.00	-35.31	(QP)
24.40	Neutral	38.86	*	73.00	60.00	-34.14	(QP)

Remark :

- (1) Reading in which marked as QP means measurements by using are Quasi-Peak Mode with Detector BW=9KHz ; SPA setting in RBW=10KHz,VBW =10KHz, Swp. Time = 0.3 sec./MHz。 Reading in which marked as AV means measurements by using are Average Mode with instrument setting in RBW=1MHz,VBW=10Hz, Swp. Time =0.3 sec./MHz。
- (2) All readings are QP Mode value unless otherwise stated AVG in column of 『Note』 . If the QP Mode Measured value compliance with the QP Limits and lower than AVG Limits, the EUT shall be deemed to meet both QP & AVG Limits and then only QP Mode was measured, but AVG Mode didn't perform。 In this case, a “ * ” marked in AVG Mode column of Interference Voltage Measured。
- (3) Measuring frequency range from 150KHz to 30MHz。

Table 4 Conducted Emission Data

Special Notes : (EUT Operation Mode or Test Configuration Mode, if applicable)

Mode 5

Judgement : Passed by -26.31 dB at 0.18 MHz AVG X QP Line X Neutral

Freq. (MHz)	Terminal L/N	Measured(dBuV)		Limits(dBuV)		Safe Margins (dBuV)		Note
		QP-Mode	AV-Mode	QP-Mode	AV-Mode			
0.18	Line	51.49	*	79.00	66.00	-27.51	(QP)	
0.24	Line	48.71	*	79.00	66.00	-30.29	(QP)	
0.31	Line	44.61	*	79.00	66.00	-34.39	(QP)	
0.64	Line	41.71	*	73.00	60.00	-31.29	(QP)	
16.31	Line	38.35	*	73.00	60.00	-34.65	(QP)	
23.26	Line	39.27	*	73.00	60.00	-33.73	(QP)	
0.18	Neutral	52.69	*	79.00	66.00	-26.31	(QP)	
0.24	Neutral	50.81	*	79.00	66.00	-28.19	(QP)	
0.31	Neutral	45.81	*	79.00	66.00	-33.19	(QP)	
0.64	Neutral	44.11	*	73.00	60.00	-28.89	(QP)	
16.31	Neutral	42.25	*	73.00	60.00	-30.75	(QP)	
24.40	Neutral	42.76	*	73.00	60.00	-30.24	(QP)	

Remark :

- (1) Reading in which marked as QP means measurements by using are Quasi-Peak Mode with Detector BW=9KHz ; SPA setting in RBW=10KHz,VBW =10KHz, Swp. Time = 0.3 sec./MHz。 Reading in which marked as AV means measurements by using are Average Mode with instrument setting in RBW=1MHz,VBW=10Hz, Swp. Time =0.3 sec./MHz。
- (2) All readings are QP Mode value unless otherwise stated AVG in column of 『Note』 . If the QP Mode Measured value compliance with the QP Limits and lower than AVG Limits, the EUT shall be deemed to meet both QP & AVG Limits and then only QP Mode was measured, but AVG Mode didn't perform。 In this case, a “ * ” marked in AVG Mode column of Interference Voltage Measured。
- (3) Measuring frequency range from 150KHz to 30MHz。

Table 4 Conducted Emission Data

Special Notes : (EUT Operation Mode or Test Configuration Mode, if applicable)

Mode 6

Judgement : Passed by -24.11 dB at 0.18 MHz AVG X QP Line X Neutral

Freq. (MHz)	Terminal L/N	Measured(dBuV)		Limits(dBuV)		Safe Margins (dBuV)		Note
		QP-Mode	AV-Mode	QP-Mode	AV-Mode			
0.18	Line	54.29	*	79.00	66.00	-24.71	(QP)	
0.24	Line	51.51	*	79.00	66.00	-27.49	(QP)	
0.31	Line	47.61	*	79.00	66.00	-31.39	(QP)	
0.49	Line	42.01	*	79.00	66.00	-36.99	(QP)	
0.64	Line	46.11	*	73.00	60.00	-26.89	(QP)	
24.40	Line	47.06	*	73.00	60.00	-25.94	(QP)	
0.18	Neutral	54.89	*	79.00	66.00	-24.11	(QP)	
0.24	Neutral	52.51	*	79.00	66.00	-26.49	(QP)	
0.30	Neutral	47.61	*	79.00	66.00	-31.39	(QP)	
0.64	Neutral	46.31	*	73.00	60.00	-26.69	(QP)	
16.84	Neutral	37.18	*	73.00	60.00	-35.82	(QP)	
24.40	Neutral	38.36	*	73.00	60.00	-34.64	(QP)	

Remark :

- (1) Reading in which marked as QP means measurements by using are Quasi-Peak Mode with Detector BW=9KHz ; SPA setting in RBW=10KHz,VBW =10KHz, Swp. Time = 0.3 sec./MHz。 Reading in which marked as AV means measurements by using are Average Mode with instrument setting in RBW=1MHz,VBW=10Hz, Swp. Time =0.3 sec./MHz。
- (2) All readings are QP Mode value unless otherwise stated AVG in column of 『Note』 . If the QP Mode Measured value compliance with the QP Limits and lower than AVG Limits, the EUT shall be deemed to meet both QP & AVG Limits and then only QP Mode was measured, but AVG Mode didn't perform。 In this case, a “ * ” marked in AVG Mode column of Interference Voltage Measured。
- (3) Measuring frequency range from 150KHz to 30MHz。

Table 5 Radiated Emission Data

Special Notes : (EUT Operation Mode or Test Configuration Mode, if applicable)

Mode 2

Judgement : Passed by -7.21 dB at 125.02 MHz X Peak QP Hor. X Vert.

<u>Freq.</u> <u>(MHz)</u>	<u>Ant.</u> <u>H/V</u>	<u>Reading(RA)</u> <u>(dBuV)</u>	<u>Corr.Factor(CF)</u> <u>(dB)</u>	<u>Measured(FS)</u> <u>(dBuV/m)</u>	<u>Limits(QP)</u> <u>(dBuV/m)</u>	<u>Safe Margins</u> <u>(dBuV/m)</u>	<u>Note</u>
125.02	V	47.22	- 14.43	32.79	40.00	- 7.21	
125.02	H	40.60	- 14.43	26.17	40.00	- 13.83	
146.64	H	38.20	- 12.87	25.33	40.00	- 14.67	
147.79	V	39.97	- 12.83	27.14	40.00	- 12.86	
152.69	H	38.07	- 12.71	25.36	40.00	- 14.64	
156.00	V	39.95	- 12.67	27.28	40.00	- 12.72	
250.00	V	51.12	- 13.61	37.51	47.00	- 9.49	
500.00	V	38.77	- 5.63	33.14	47.00	- 13.86	
625.01	H	37.05	- 1.87	35.18	47.00	- 11.82	
750.01	H	34.40	0.44	34.84	47.00	- 12.16	
875.00	V	28.92	3.48	32.40	47.00	- 14.60	
875.01	H	32.20	3.48	35.68	47.00	- 11.32	

Remark :

- (1) Reading in which marked as QP or Peak means measurements by using are Quasi-Peak Mode or Peak Mode with Detector BW=120KHz ; SPA setting in RBW=120KHz, VBW =120KHz, Swp. Time = 0.3 sec./MHz.
- (2) All readings are Peak unless otherwise stated QP in column of 『Note』 . Peak denotes that the Peak reading compliance with the QP Limits and then QP Mode measurement didn't perform.
- (3) Measuring frequency range from 30MHz to 1000MHz.
- (4) If the peak scan value lower limit more than 20dB, then this signal data does not how in table.

Table 5 Radiated Emission Data

Special Notes : (EUT Operation Mode or Test Configuration Mode, if applicable)

Mode 3

Judgement : Passed by -9.55 dB at 625.00 MHz X Peak QP X Hor. Vert.

<u>Freq.</u> <u>(MHz)</u>	<u>Ant.</u> <u>H/V</u>	<u>Reading(RA)</u> <u>(dBuV)</u>	<u>Corr.Factor(CF)</u> <u>(dB)</u>	<u>Measured(FS)</u> <u>(dBuV/m)</u>	<u>Limits(QP)</u> <u>(dBuV/m)</u>	<u>Safe Margins</u> <u>(dBuV/m)</u>	<u>Note</u>
48.20	V	44.80	- 15.41	29.39	40.00	- 10.61	
60.40	V	43.62	- 15.65	27.97	40.00	- 12.03	
62.10	H	40.50	- 15.93	24.57	40.00	- 15.43	
112.80	V	43.37	- 15.77	27.60	40.00	- 12.40	
116.70	H	38.02	- 15.27	22.75	40.00	- 17.25	
141.50	H	37.60	- 13.13	24.47	40.00	- 15.53	
250.00	V	50.27	- 13.61	36.66	47.00	- 10.34	
500.00	V	40.05	- 5.63	34.42	47.00	- 12.58	
625.00	V	35.85	- 1.87	33.98	47.00	- 13.02	
625.00	H	39.32	- 1.87	37.45	47.00	- 9.55	
750.01	H	36.20	0.44	36.64	47.00	- 10.36	
875.01	H	31.32	3.48	34.80	47.00	- 12.20	

Remark :

- (1) Reading in which marked as QP or Peak means measurements by using are Quasi-Peak Mode or Peak Mode with Detector BW=120KHz ; SPA setting in RBW=120KHz, VBW =120KHz, Swp. Time = 0.3 sec./MHz.
- (2) All readings are Peak unless otherwise stated QP in column of 『Note』 . Peak denotes that the Peak reading compliance with the QP Limits and then QP Mode measurement didn't perform.
- (3) Measuring frequency range from 30MHz to 1000MHz.
- (4) If the peak scan value lower limit more than 20dB, then this signal data does not how in table.

Table 5 Radiated Emission Data

Special Notes : (EUT Operation Mode or Test Configuration Mode, if applicable)

Mode 5

Judgement : Passed by -7.63 dB at 125.02 MHz X Peak QP Hor. X Vert.

Freq. (MHz)	Ant. H/V	Reading(RA) (dBuV)	Corr.Factor(CF) (dB)	Measured(FS) (dBuV/m)	Limits(QP) (dBuV/m)	Safe Margins (dBuV/m)	Note
57.90	V	41.47	- 15.63	25.84	40.00	- 14.16	
65.50	V	44.52	- 16.51	28.01	40.00	- 11.99	
82.00	H	42.57	- 18.56	24.01	40.00	- 15.99	
114.50	H	39.62	- 15.59	24.03	40.00	- 15.97	
125.01	H	38.80	- 14.43	24.37	40.00	- 15.63	
125.02	V	46.80	- 14.43	32.37	40.00	- 7.63	
250.00	V	47.17	- 13.61	33.56	47.00	- 13.44	
500.00	H	39.30	- 5.63	33.67	47.00	- 13.33	
750.00	H	35.12	0.44	35.56	47.00	- 11.44	
750.00	V	31.52	0.44	31.96	47.00	- 15.04	
875.00	V	28.62	3.48	32.10	47.00	- 14.90	
875.00	H	29.62	3.48	33.10	47.00	- 13.90	

Remark :

- (1) Reading in which marked as QP or Peak means measurements by using are Quasi-Peak Mode or Peak Mode with Detector BW=120KHz ; SPA setting in RBW=120KHz, VBW =120KHz, Swp. Time = 0.3 sec./MHz.
- (2) All readings are Peak unless otherwise stated QP in column of 『Note』 . Peak denotes that the Peak reading compliance with the QP Limits and then QP Mode measurement didn't perform.
- (3) Measuring frequency range from 30MHz to 1000MHz.
- (4) If the peak scan value lower limit more than 20dB, then this signal data does not how in table.

Table 5 Radiated Emission Data

Special Notes : (EUT Operation Mode or Test Configuration Mode, if applicable)

Mode 6

Judgement : Passed by -10.40 dB at 625.00 MHz X Peak QP Hor. X Vert.

<u>Freq.</u> <u>(MHz)</u>	<u>Ant.</u> <u>H/V</u>	<u>Reading(RA)</u> <u>(dBuV)</u>	<u>Corr.Factor(CF)</u> <u>(dB)</u>	<u>Measured(FS)</u> <u>(dBuV/m)</u>	<u>Limits(QP)</u> <u>(dBuV/m)</u>	<u>Safe Margins</u> <u>(dBuV/m)</u>	<u>Note</u>
64.50	H	40.52	- 16.36	24.16	40.00	- 15.84	
125.00	V	43.40	- 14.43	28.97	40.00	- 11.03	
125.00	H	40.80	- 14.43	26.37	40.00	- 13.63	
145.28	V	40.87	- 12.92	27.95	40.00	- 12.05	
151.41	V	39.40	- 12.72	26.68	40.00	- 13.32	
163.56	H	37.25	- 12.99	24.26	40.00	- 15.74	
375.00	V	44.62	- 9.13	35.49	47.00	- 11.51	
500.00	V	39.50	- 5.63	33.87	47.00	- 13.13	
625.00	H	37.05	- 1.87	35.18	47.00	- 11.82	
625.00	V	38.47	- 1.87	36.60	47.00	- 10.40	
750.01	H	35.87	0.44	36.31	47.00	- 10.69	
875.01	H	29.20	3.48	32.68	47.00	- 14.32	

Remark :

- (1) Reading in which marked as QP or Peak means measurements by using are Quasi-Peak Mode or Peak Mode with Detector BW=120KHz ; SPA setting in RBW=120KHz, VBW =120KHz, Swp. Time = 0.3 sec./MHz.
- (2) All readings are Peak unless otherwise stated QP in column of 『Note』 . Peak denotes that the Peak reading compliance with the QP Limits and then QP Mode measurement didn't perform.
- (3) Measuring frequency range from 30MHz to 1000MHz.
- (4) If the peak scan value lower limit more than 20dB, then this signal data does not how in table.

Attachment

Table Contents

- A. EUT Modification Description
- B. EUT Test Photos
- C. EUT Photos

Attachment - A.

EUT Modification Description

Attachment - B.

EUT Test Photos

- 1. Conducted Measurement Photos**
- 2. Radiated Measurement Photos**

Conducted Measurement Photos



Radiated Measurement Photos



Attachment – C

EUT Photos

1. Photo # 1 Front View
2. Photo # 2 Rear View
3. Photo # 3 Side View
4. Photo # 4~8 Unit Partially Disassembled

Photo # 1

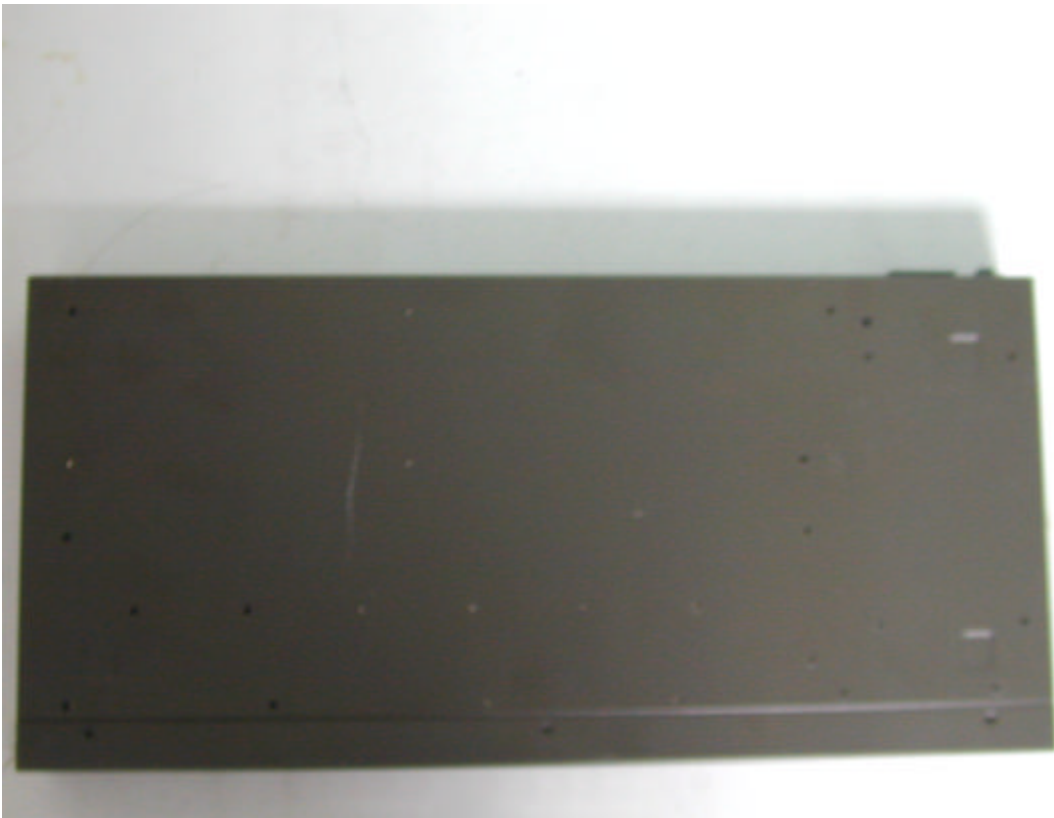

Photo # 2



Photo # 3

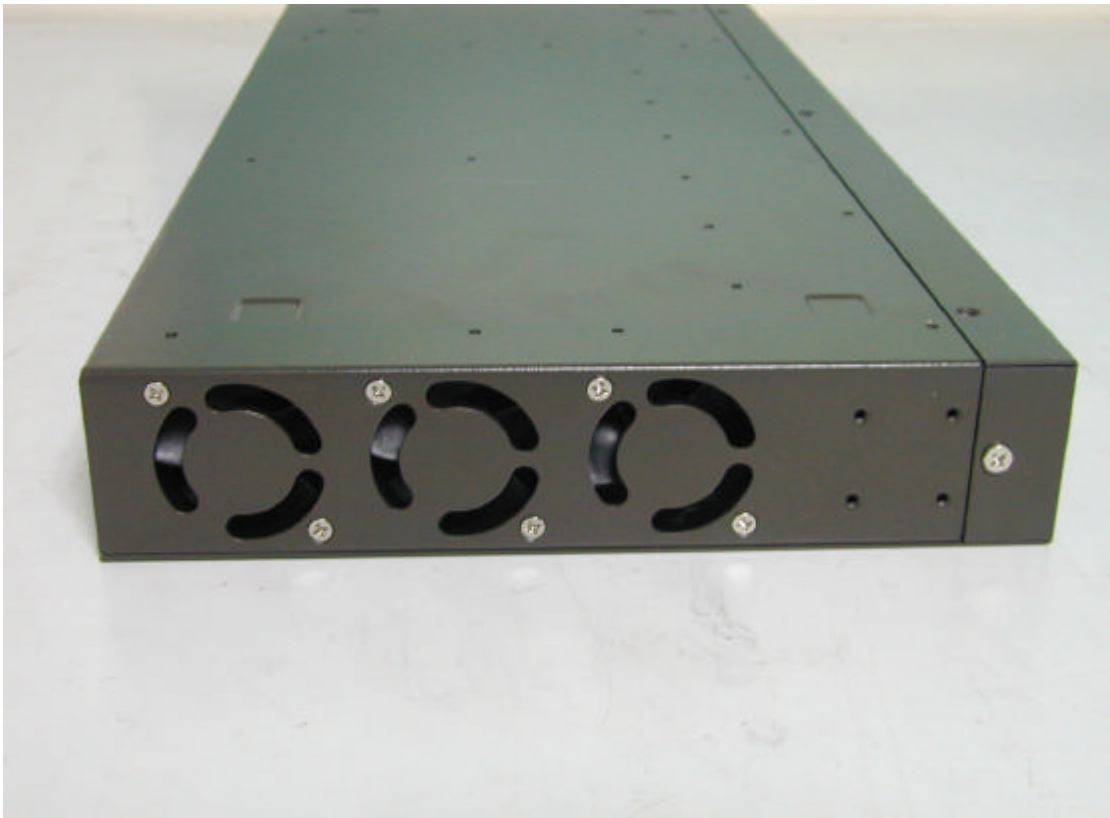

Photo # 4



Photo # 5

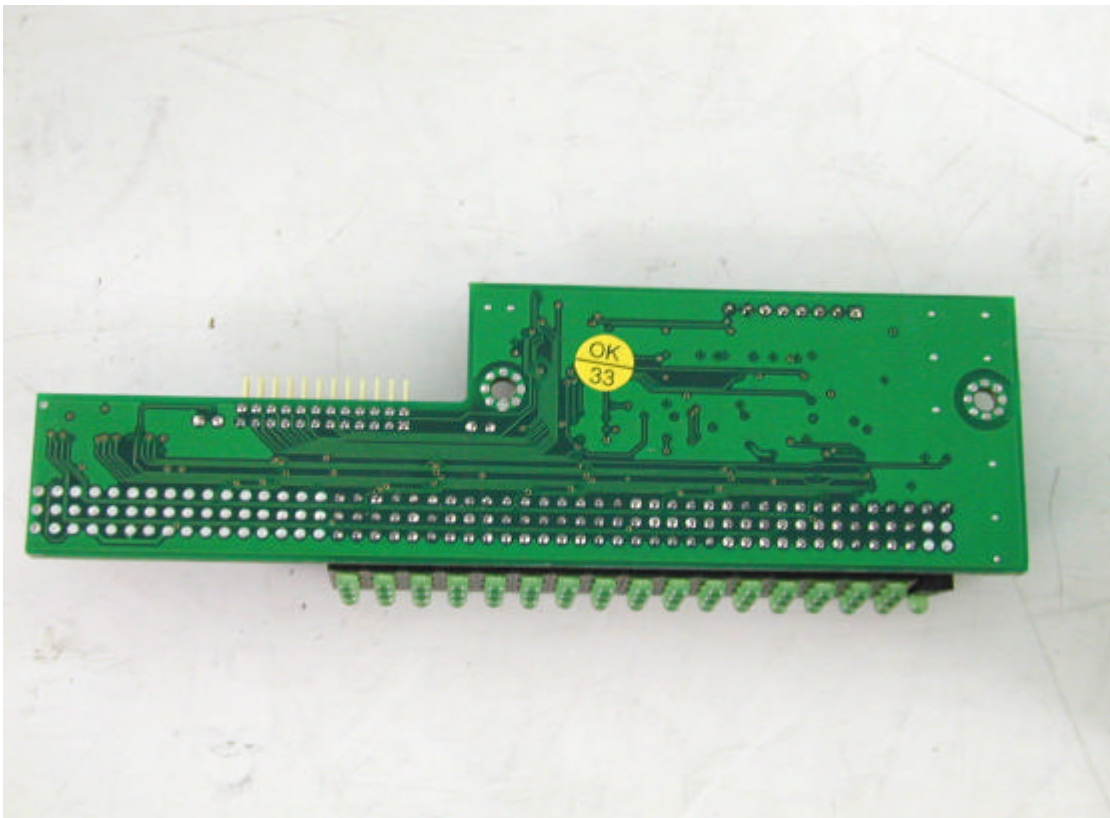
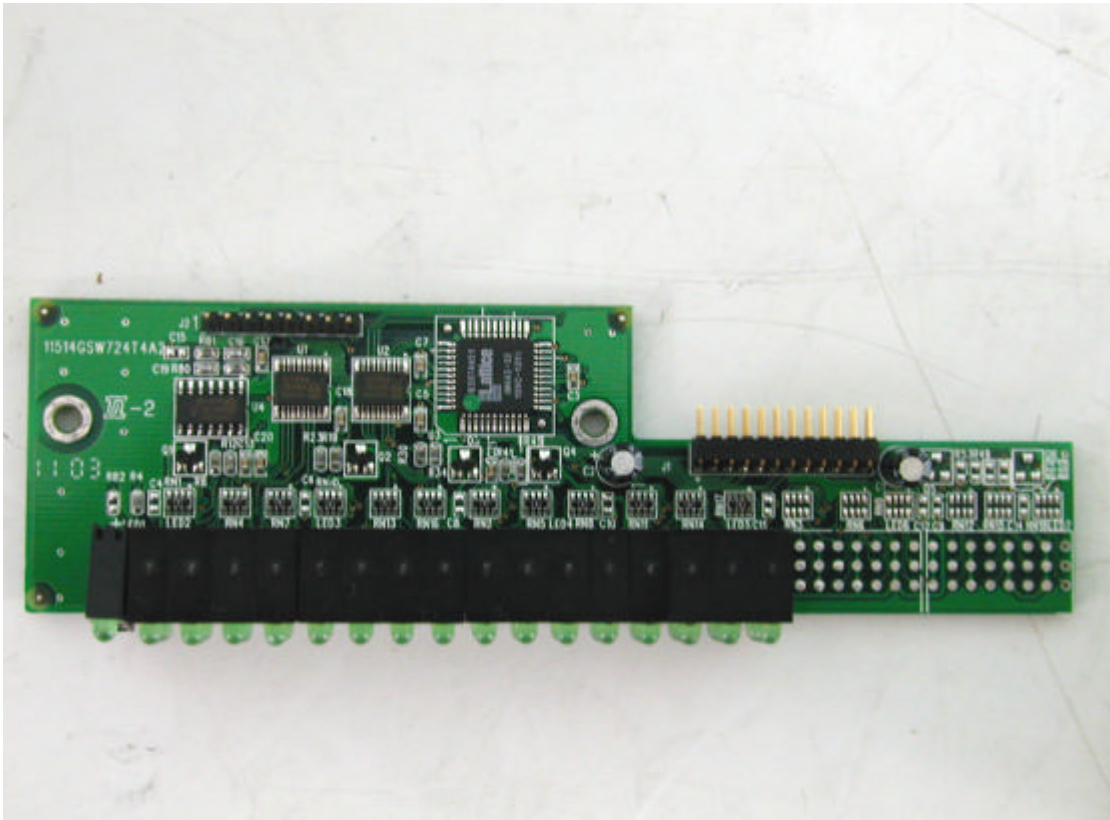

Photo # 6

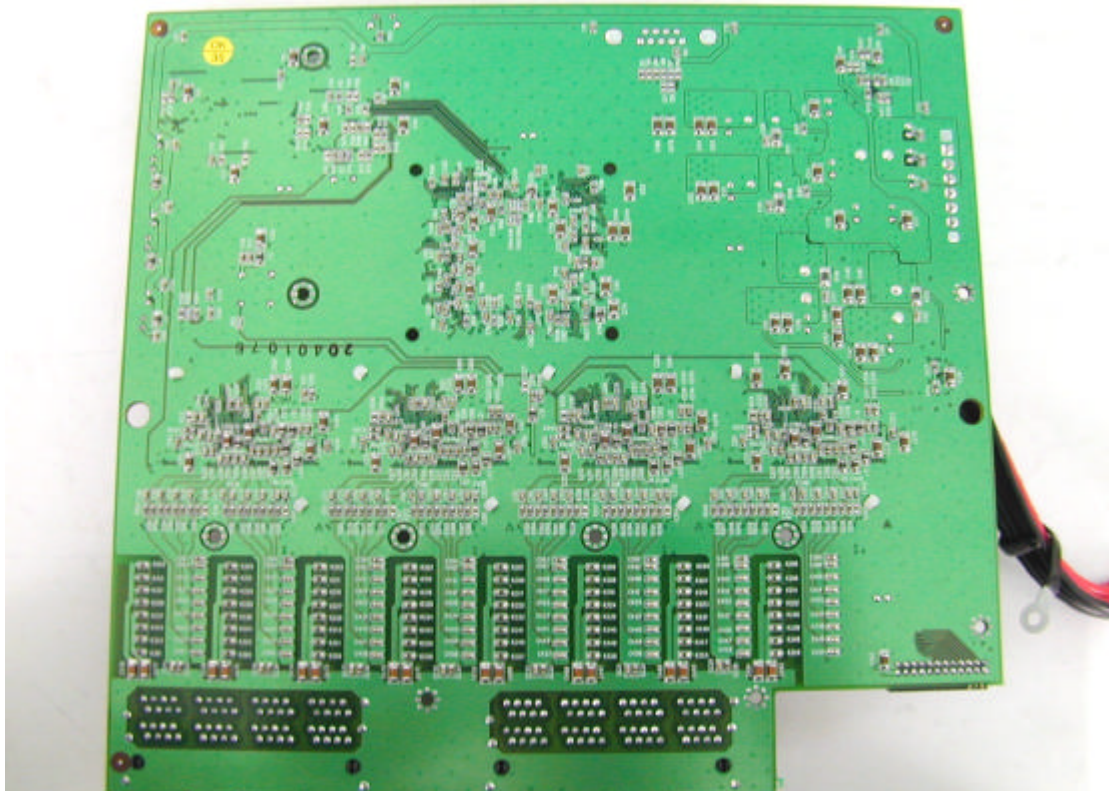
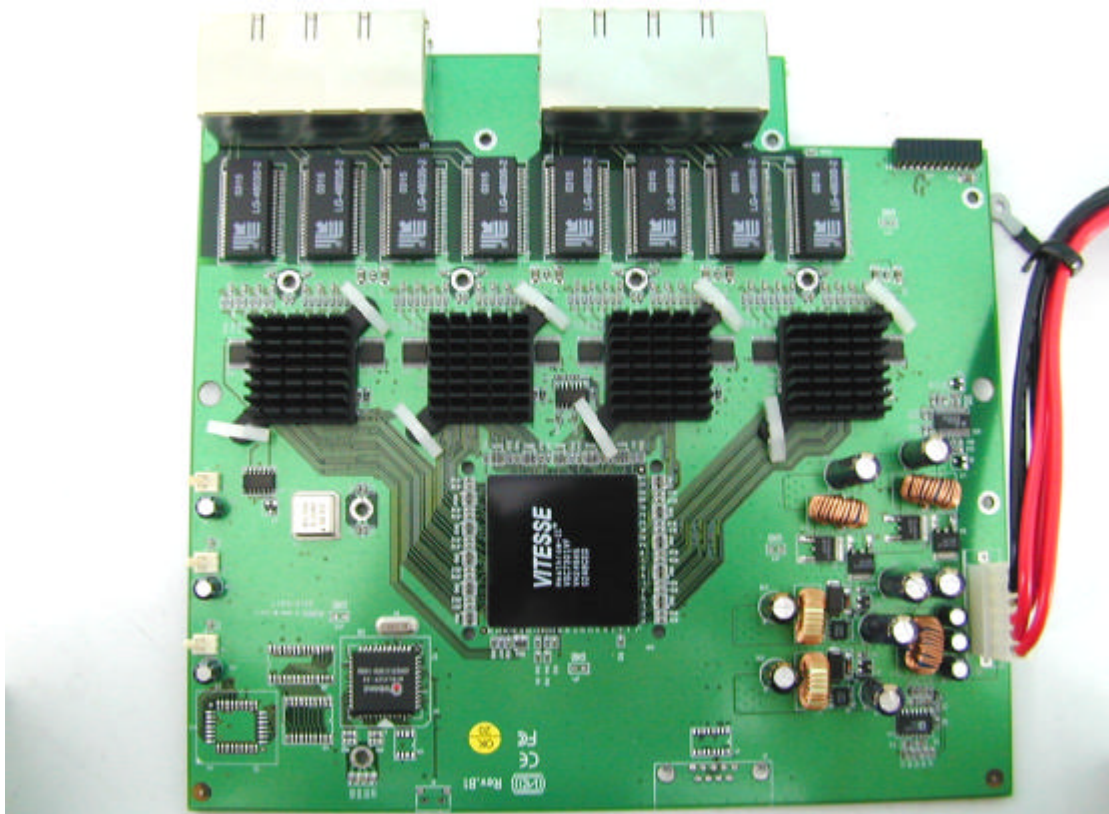

Photo # 7

Model No.:SA40-050100

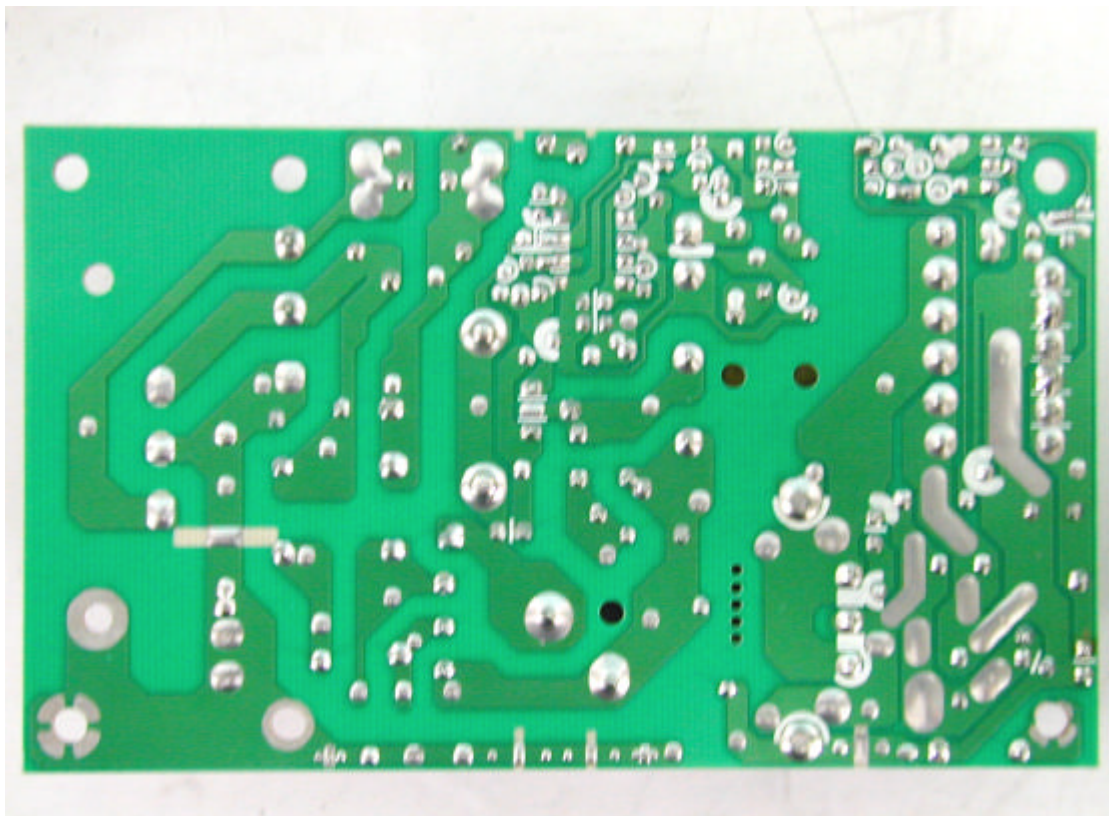
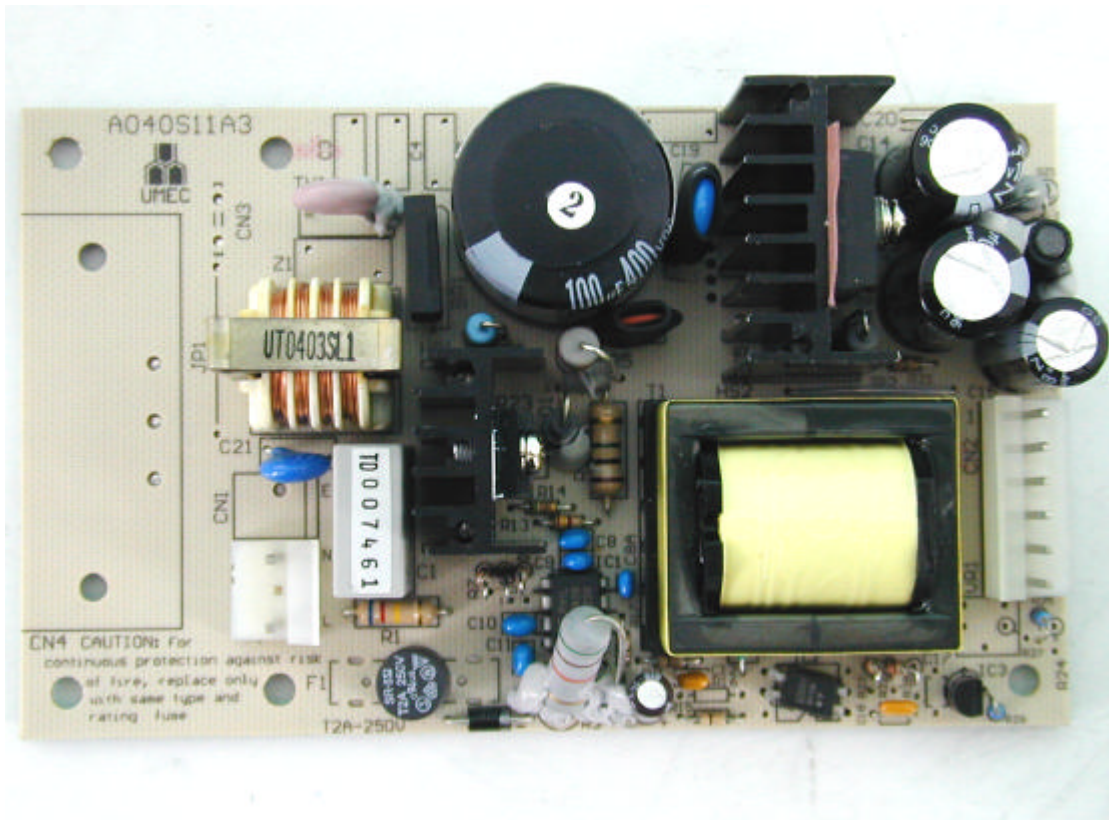

Photo # 8

Model No.:UP0401S-05L1

